



**promosolution**  
ADVERTISING & GADGET  
2022 | 2023

# INDICE

7

## ABBIGLIAMENTO

T-SHIRT  
POLO  
FELPE  
PILE  
GIUBBINI  
GILET  
SPORT WEAR  
WORK  
IGIENE & PROTEZIONE  
CAPPELLI

167

## GRANDI FIRME

THE BRIDGE  
HUGO BOSS  
CERRUTI  
LAVILLE PARIS  
JAGUAR  
CHRISTIAN LACROIX

201

## MEETING&NOTES

ZAINI  
BORSE  
CARTELLE  
PORTABLOCCO  
BUSTE  
BLOCK NOTES  
TACCUINI  
SET MEMO  
CUBO CARTA

225

## PENNE

PENNE MAXEMA  
PENNE PARKER  
PENNE HUGO BOSS  
PENNE LAVILLE  
PENNE STILOLINEA  
MATITE  
STILOFORI  
SET COLORI  
ASTUCCI PORTAPENNE

273

## ACCENDINI

ACCENDINI IN PLASTICA  
ACCENDINI IN METALLO  
ACCENDIGAS  
POSACENERE

279

## PORTACHIAVI

PORTACHIAVI  
LANYARD  
PORTABADGE  
BRACCIALETTI

291

## HI-TECH & OFFICE

CALCOLATRICI  
PORTA PENNE  
POWER BANK  
SPEAKER  
CHIAVETTE USB  
AURICOLARI  
PORTACHIAVI TOUCH  
TAPPETINI MOUSE  
OROLOGI DA PARETE

309

## SHOPPER

SHOPPER IN COTONE  
SHOPPER IN TNT  
SHOPPER IN PPL  
SHOPPER RICHIUDIBILI  
PORTABICCHIERE  
PORTABOTTIGLIE

329

## WINE&HOME

LUNCH BOX  
POSATE  
TAZZE  
BICCHIERI  
BILANCIA  
APRIBOTTIGLIE  
SET VINO  
TAGLIERE  
TAGLIAPIZZA  
GREMBIULI

345

## BEAUTY

SPECCHIETTI  
SET MANICURE  
SPAZZOLE  
PETTINE  
BEAUTY  
POCHETTE  
LIME PER UNGHIE  
VENTAGLIO  
PENNA ROSSETTO

351

## OMBRELLI

OMBRELLI AUTOMATICI  
OMBRELLI MAXI  
OMBRELLI MINI  
OMBRELLI PIEGHEVOLI  
OMBRELLO LAVILLE

359

## TERMOSALDATI

PORTACARD  
PORTALOTTO  
PORTARICETTE  
PORTABIGLIETTO AEREO  
PORTANOME VALIGIE

365

## AUTO&MOTO

PORTA DOCUMENTI  
PORTA ASSICURAZIONI  
PORTA TARGA  
PORTA POLIZZA  
DISCO ORARIO

373

## UTILITY

FLESSOMETRI  
DOPPIO METRO  
MATITA FALEGNAMI  
TAGLIERINI  
ARTICOLI  
FARMACEUTICI  
PORTASCARPE  
PORTA ABITI  
CALZASCARPE

379

## ZAINI&SPORTBAG

ZAINI PORTA PC  
ZAINI TEMPO LIBERO  
ZAINI CAMOUFLAGE  
BORSONI SPORT

403

## TEMPO LIBERO

BORRACCE  
TAZZE  
BICCHIERI  
LUNCH BOX  
SET POSATE  
BILANCIA  
BORSA TERMICA  
VENTAGLIO  
OCCHIALI DA SOLE  
PORTA CELLULARE  
BRACCIALETTI

415

## AGENDE

AGENDE IN PELLE  
AGENDE IN SIMILPELLE  
AGENDE BLOCCO FISSO  
AGENDE IN VIVELLA  
AGENDINE TASCABILI  
PLANNING CON SPIRALE

453

## CALENDARI

CALENDARI DA PARETE  
CALENDARI DA TAVOLO  
PLANNING



## DESIGN, PRESTAZIONE E PROTEZIONE

### VESTIRE BENE, LAVORARE MEGLIO

L'abbigliamento **workwear** e **corporate wear** Payper è progettato per **agevolare** i movimenti della persona e per **proteggere** con capi **dall'estetica curata**, tipica dello **stile italiano**.

La nostra selezione è caratterizzata da prodotti qualificati da **brevetti** e da **numerose certificazioni**. L'obiettivo è fornire articoli che rendano **le prestazioni dei lavoratori più sicure, più pratiche e con maggior fascino**.



## LA QUALITÀ DEI PRODOTTI INIZIA DALLA SCELTA DELLE MATERIE PRIME



I principali fornitori Payper producono **con materiali certificati OEKO-TEX®** (International Association for Research and Testing in the Field of Textile and Leather Ecology): un **sistema di controllo e certificazione per le materie prime, i semilavorati e i prodotti finiti del settore tessile ad ogni livello di lavorazione** che **garantisce l'assenza di sostanze nocive alla salute sui prodotti**.



## FAI UNA SCELTA SICURA

Moltissimi articoli di categorie merceologiche di **t-shirt**, **polo** e **felpe** sono **contrassegnate** come **DPI (Dispositivi di Protezione Individuale)** di **CATEGORIA I**, ovvero hanno superato costantemente nel tempo i test previsti per l'innocuità, la resistenza meccanica e la variazione dimensionale dopo i lavaggi.

CE I CAT



INNOCUITÀ



RESISTENZA MECCANICA



VARIAZIONE DIMENSIONALE



Nella prova di resistenza, grazie ad un'accurata selezione della **qualità e della lunghezza delle fibre di cotone**, sono stati raggiunti valori notevolmente superiori a quanto previsto dalla norma. Per molti articoli diventati DPI, è stata aumentata la temperatura di lavaggio consentita a 40°C, al termine di **5 cicli di lavaggio**. Per le produzioni di **capi in cotone vengono utilizzati coloranti reattivi** (reactive dyes), cioè tinte che

determinano un'alta **solidità del colore**, in grado di resistere maggiormente al degrado per effetto del tempo, delle condizioni ambientali avverse, della manutenzione con lavaggi fino a 60°C.



## DISPOSITIVI DI PROTEZIONE INDIVIDUALE

Gli articoli **Work & Safety Payper** sono certificati in conformità al Regolamento (UE) 2016/425 sui DPI (Dispositivi di Protezione Individuale).

**CE II CAT** Gli articoli di abbigliamento da lavoro **Alta Visibilità** sono riconosciuti come dispositivi di protezione individuale che appartengono alla **CATEGORIA II RISCHI di livello intermedio** e sono conformi alle disposizioni del Regolamento (UE) 2016/425 ed alle norme: UNI EN ISO13688:2013 (Indumenti di protezione-Requisiti generali).



# SCEGLI PRESTAZIONE E PROTEZIONE

L'abbigliamento da lavoro Payper risponde ai requisiti della norma EN ISO 13688:2013.

ERGONOMIA, INNOCUITÀ, DESIGNAZIONE DELLE TAGLIE, INVECCHIAMENTO, COMPATIBILITÀ E MARCATURA DEGLI INDUMENTI DI PROTEZIONE



ALTA VISIBILITÀ  
EN ISO 20471:2013+A1:2016

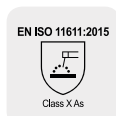

SALDATURA E PROCEDIMENTI CONNESSI  
EN ISO 11611:2015



PROTEZIONE AMBIENTI FREDDI  
EN 14058:2017



AGENTI CHIMICI LIQUIDI  
EN 13034:2005 + A1:2009



CALORE E FIAMMA (INFIAMMIBILITÀ)  
EN ISO 14116:2015



CALORE E FIAMMA (PERICOLI TERMICI)  
EN ISO 11612:2015



PIOGGIA - EN 343:2019



PROPRIETÀ ELETTROSTATICHE  
EN 1149-5:2018



ARCO ELETTRICO  
IEC/EN 61842-2:2018

**promo**solution

**T-SHIRT**



**SUNSET  
T-SHIRT**







## AY 7443 SUNSET

T-Shirt girocollo, manica corta, colletto in costina misto spandex da 1,5 cm con cucitura ribattuta sul davanti, nastro di rinforzo da spalla a spalla, struttura tubolare.

CE I CAT

 Cotone Jersey - 155 g/mq

 XS - S - M - L - XL - XXL - 3XL  
(Bianco, Blu, Royal, Melange, Nero, Smoke, Arancio, Rosso disponibili anche 4XL - 5XL)

 5/100



LA TUA  
ESTATE A  
COLORI



**SUNSET  
LADY**

SURF CLUB  
**PAYPER**  
LIVE YOUR DREAM. DRESS PAYPER.





## AY 7446 SUNSET LADY

T-Shirt girocollo, manica corta, colletto in costina misto spandex da 1,5 cm con cucitura ribattuta sul davanti, nastro di rinforzo da spalla a spalla, taglio sfiancato.

CE I CAT

 Cotone Jersey - 155 g/mq

 XS - S - M - L - XL  
(Bianco, Nero, Blu, Smoke, Royal disponibili anche XXL)

 5/100



**TAGLIO SFIANCATO**

# T-SHIRT





## AY 7450 PRINT

T-Shirt girocollo, manica corta, colletto in costina misto spandex da 1,5 cm con cucitura ribattuta sul davanti, nastro di rinforzo da spalla a spalla, struttura tubolare.

CE I CAT

 Cotone Jersey- 150 g/mq

 XS - S - M - L - XL - XXL - 3XL  
(Bianco, Arancione, Blu,  
Royal, Nero, Steel Gray  
disponibili anche 4XL - 5XL)

 10/100



BI



## STRUTTURA TUBOLARE



## AY 7485 SUNSET KIDS

T-shirt bambino cotone jersey  
pettinato girocollo manica corta,  
colletto in costina con cucitura  
ribattuta sul davanti, nastro di  
rinforzo da spalla a spalla.

**i** Cotone Jersey - 155 g/mq

**o** XS (3/4 ANNI)  
S(5/6) - M (7/8) - L(9/10)  
XL(11/12) XXL(13/14)  
(Rosso e Bianco disponibile  
anche in XXS-1/2 ANNI)

**o** 5/100



# T-SHIRT



## AY 7465 SUNRISE

T-shirt da uomo in cotone jersey girocollo manica corta, colletto in costina misto spandex da 1.5 cm con cucitura ribattuta sul davanti, nastro di rinforzo da spalla a spalla in colore a contrasto visibile nel colletto, cuciture stretch, cucita lateralmente. Disponibile anche: **LADY**

CE I CAT

**i** Cotone jersey - 190 g/mq

**o** XS - S - M - L - XL - XXL - 3XL  
(Blu, Royal, Nero e Bianco  
disponibile anche in  
4XL - 5XL)

**o** 5/100

NE



BL



RY



VE



RO



**CUCITURE  
STRECH  
RINFORZI  
SU SPALLE**

BI

**AY 7453  
FLAG**

T-shirt uomo, 100% cotone pettinato, colletto e bordo maniche in Rib con tricolore, struttura tubolare, collo nastrato tricolore.

CE I CAT

 Cotone Jersey - 150 g/mq

 S - M - L - XL - XXL - 3XL

 5/100

BL



RY



NE



BI



**T-SHIRT**  
colletto  
TRICOLORE

# T-SHIRT





## AY 7464 V-NECK LADY

T-shirt collo a V manica corta sfiancata da donna, colletto in costina misto spandex da 1,5 cm con cucitura ribattuta sul davanti, nastro di rinforzo da spalla a spalla in colore a contrasto visibile nel colletto, cuciture stretch, cucita lateralmente.

CE I CAT

 Cotone Jersey - 150 g/mq

 XS - S - M - L - XL  
(Royal, Bianco, Smoke, Nero  
disponibili anche XXL)

 5/100

SM



RY



BL



NE



RO



FX



## T-SHIRT LADY

BI



COLLO A  
“ V ”







### AY 7466 V-NECK

T-shirt da uomo collo a V manica corta, colletto in costina misto spandex da 1,5 cm con cucitura ribattuta sul davanti, nastro di rinforzo da spalla a spalla in colore a contrasto visibile nel colletto, cuciture stretch, struttura tubolare.

CE I CAT

 Cotone Jersey - 150 g/mq

 S - M - L - XL - XXL - 3XL  
4XL - 5XL

 5/100



## T-SHIRT UOMO



RY

COLLO A  
“V”

# T-SHIRT



## AY 7458 CORPORATE

T-shirt bicolore, taschino al petto con porta penna, cuciture del collo coperte e nastro di rinforzo laterale.

CE I CAT

 Cotone 60% + Poliestere 40%  
165 g/mq

 XS-S-M-L-XL-XXL-3XL-4XL-5XL

 5/50

NE/SM



SM/NE



BI/SM



BL/RV



RV/BL



RETRO



# PROFESSIONAL LOOK

RO/SM





CON  
TASCHINO



### AY 7475 RUNNER

T-shirt da uomo tecnica-sportiva con manica raglan, doppia cucitura laterale per una migliore vestibilità, nastratura al collo. Disponibile anche: **LADY**

-  Poliestere dry-tech  
150 g/mq
-  S - M - L - XL - XXL - 3XL
-  5/50



## T-SHIRT TECNICO-SPORTIVA

VFL

**MANICA  
RAGLAN**

# T-SHIRT



## AY 7500 PINETA

T-shirt da uomo girocollo manica lunga, colletto in costina misto spandex da 1.5 cm con cucitura ribattuta sul davanti, nastro di rinforzo da spalla a spalla in colore a contrasto visibile nel colletto, cuciture stretch, cucita lateralmente.

CE I CAT

 Cotone Jersey - 165 g/mq

 S - M - L - XL - XXL - 3XL  
4XL - 5XL

 5/50

BL



RY



NE



SM



## T-SHIRT UOMO MANICA LUNGA STRUTTURA TUBOLARE



BI



### AY 7501 PINETA LADY

T-shirt girocollo manica lunga da donna, colletto e polsino in costina misto spandex con cucitura ribattuta sul davanti, nastro di rinforzo da spalla a spalla, cucitura laterale per una migliore vestibilità.

CE I CAT

 Cotone Jersey - 165 g/mq

 S - M - L - XL - XXL

 5/50



## T-SHIRT DONNA

### MISTO SPANDEX

### MANICA LUNGA



BI



# T-SHIRT



## AY 7493 SHORE

Canotta uomo, spalla larga. Girocollo a costina rinforzata, nastro di rinforzo interno da spalla a spalla.

CE I CAT

Cotone Jersey- 150 g/mq

S - M - L - XL - XXL

5/100



## CANOTTA SPALLA LARGA

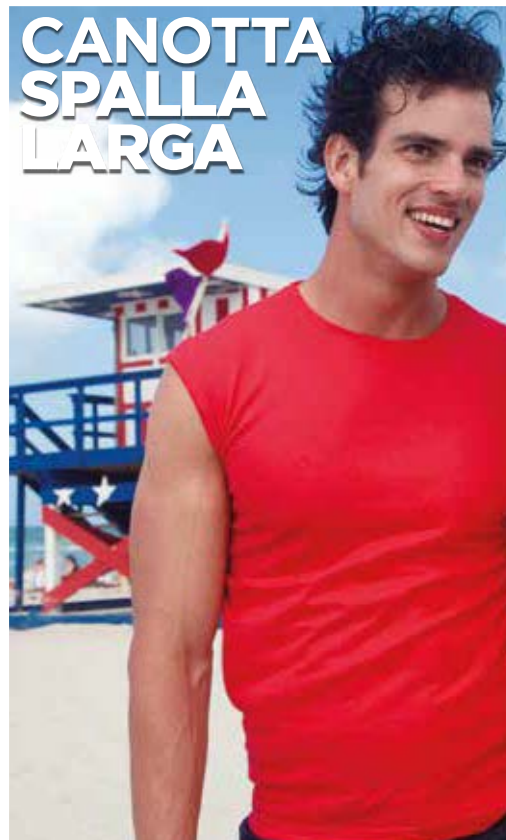

## AY 7496 LOOK

Canotta sfiancata da donna con girocollo ampio, colletto e bordo manica da 1 cm, spalline incrociate sul retro.

CE I CAT

Cotone - 190 g/mq

S - M - L - XL

5/100



## CANOTTA TAGLIO SFIANCATO



**promo**solution

**POLO**



**AY 7440  
VENICE**

Polo da uomo a manica corta con 3 bottoni in tinta effetto perlato, colletto e bordo manica a costine, spacchetti laterali, cuciture del collo coperte con nastro a contrasto, cuciture stretch, nastro di rinforzo laterale, rinforzo sagomato retrocollo, 100% cotone piquet.

CE I CAT

Cotone Piquet - 200 g/mq

XS - S - M - L - XL - XXL - 3XL  
(Bianco, Arancione, Rosso, Bordeaux, Verde, Jelly Green, Verde Acido, Verde Militare, Blu, Royal, Blu Atollo, Smoke, Nero disponibile anche 4XL-5XL)

5/50



BA







**AY 7439  
VENICE LADY**

Polo sfiancata da donna a manica corta con 4 bottoni in tinta effetto perlato, colletto e bordo manica a costine, spacchetti laterali, cuciture del collo coperte con nastro a contrasto, cuciture stretch, nastro di rinforzo laterale, rinforzo sagomato retrocollo; 100% cotone piquet.

CE I CAT

**i** Cotone Piquet - 200 g/mq

**S - M - L - XL** (Bianco, Rosso, Arancione, Bordeaux, Verde, Jelly Green, Verde Acido, Blu, Royal, Blu Atollo, Smoke, Nero disponibile anche XXL)

**5/50**



BI





**AY 7404  
ROME**

Polo a manica corta con 3 bottoni in tinta effetto perlato, spacchetti laterali, cuciture del collo coperte con nastro in tinta.

CE I CAT

Cotone Piquet - 185 g/mq

XS - S - M - L - XL - XXL - 3XL  
(Arancione, Rosso, Blu, Royal, Smoke, Light Smoke, Nero disponibile anche 4XL e 5XL)

5/50



POLO  
MANICA  
CORTA  
**TRE  
BOTTONI**



**AY 7575  
COMPANY**

Polo bicolore a manica corta con 3 bottoni in tinta, taschino al petto con portapenna, bordo maniche a costine, spacchetti laterali, cuciture del collo coperte.

CE I CAT

**i** Cotone 60% + Poliestere 40%  
Piquet - 230 g/mq

**o** XS - S - M - L - XL - XXL - 3XL  
4XL - 5XL

**u** 5/50

NE/SM



BI/SM



SM/NE



RY/BL



PROFESSIONAL  
LOOK

BL/RY



RO/SM



CON TASCHINO  
PORTA PENNE

RETRO





**AY 7412  
PRESTIGE**

Polo manica corta con 4 bottoni in tinta e con colletto modello camicia; taschino frontale lato cuore e fini inserti in oxford celeste su interno collo, spacchetti laterali e nell'apertura frontale, etichetta transfer, 100% cotone piquet.

CE I CAT

 Cotone Piquet - 190 g/mq

 S - M - L - XL - XXL - 3XL

 5/25

**POLO IN  
PIQUET  
DI ALTA  
QUALITÀ  
CON  
TASCHINO**



BI





## AY 7413 GLAMOUR LADY

Polo sfiancata da donna manica corta a 5 bottoni in tinta effetto perlato, colletto e bordo maniche a costine, fini inserti in popeline celeste su interno collo e spacchetti laterali, rinforzo sagomato retrocollo; 100% cotone piquet.

CE I CAT

 Cotone Piquet - 190 g/mq

 S - M - L - XL

 5/25

# POLO CON 5 BOTTONI



HC



BL



BI

NE



EG



BA





## AY 7433 CAMBRIDGE

Polo da uomo a manica corta con 3 bottoni bianchi, con interno collo, patta e spacchetti laterali in oxford celeste, colletto e bordo manica in rib con fine profilo a contrasto, occhielli sottobraccio, spacchetti laterali con cucitura di rinforzo, nastro di rinforzo laterale, cuciture stretch, rinforzo sagomato retrocollo; 100% cotone jersey.

CE I CAT

 Cotone jersey - 175 g/mq

 S - M - L - XL - XXL - 3XL  
4XL - 5XL

 5/25

BL/BI



AR/BI



VI/BI



RO/BI



## POLO UOMO

### COLLO e MANICA A CONTRASTO

NE/BI



ML/BL



BI/BL



RY/BI



3 BOTTONI



## AY 7430 LEEDS

Polo donna sfiancata a manica corta con 6 bottoni bianchi con interno collo, patta e spacchetti laterali in oxford celeste, colletto e bordo manica in rib con fine profilo a contrasto, occhielli sottobraccio, spacchetti laterali con cucitura di rinforzo, nastro di rinforzo laterale, cuciture stretch, rinforzo sagomato retrocollo; 100% cotone jersey.

CE I CAT

 Cotone jersey - 175 g/mq

 S - M - L - XL

 5/25

NE/BI



BI/BL



RY/BI



AR/BI



RO/BI



BL/BI



**6 BOTTONI**  
**SPACCHI**  
**LATERALI**  
**OCCHIELLI**  
**SOTTOBRACCIO**



## AY 7414 MEMPHIS

Polo da uomo a manica corta con 3 bottoni in tinta ad effetto perlato, colletto da un lato in tinta dall'altro lato con colori a contrasto a fasce, visibile solo se alzato. Interno abbottonatura collo e spacchetti laterali con contrasto, bordo manica dx con fine inserto nei colori del collo, bordo manica a costine, cuciture del collo coperte con nastro a contrasto, nastro di rinforzo laterale, rinforzo sagomato retro collo; 100% cotone jersey.

CE I CAT

 Cotone jersey - 175 g/mq

 S - M - L - XL - XXL - 3XL

 5/25



## POLO 3 BOTTONI



MANICHE  
COLLO E  
SPACCHETTI  
A CONTRASTO





### AY 7415 MEMPHIS LADY

Polo sfiancata donna a manica corta con 6 bottoni in tinta ad effetto perlato, colletto da un lato in tinta dall'altro lato con colori a contrasto a fasce, visibile solo se alzato. Interno abbottonatura collo e spacchetti laterali con contrasto, bordo manica dx con fine inserto nei colori del collo, bordo manica a costine, cuciture del collo coperte con nastro a contrasto, nastro di rinforzo laterale, rinforzo sagomato retrocollo; 100% cotone jersey.

CE I CAT

 Cotone jersey - 175 g/mq

 S - M - L - XL

 5/25

NE



SM



BL



RY



## POLO LADY 6 BOTTONI



BI

MANICHE  
COLLO E  
SPACCHETTI  
A CONTRASTO



## AY 7438 SKIPPER

Polo da uomo manica corta con 3 bottoni bianchi, collo e bordo manica con fine profilo a contrasto, colletto e bordo manica a costine, spacchetti laterali con cucitura di rinforzo, cuciture del collo coperte, nastro di rinforzo laterale, cuciture stretch, rinforzo sagomato retrocollo; 100% cotone piquet.

CE I CAT

**i** Cotone Piquet - 210 g/mq

**o** S - M - L - XL - XXL - 3XL  
(Bianco, Blu, Royal, Nero  
disponibili anche 4XL e 5XL)

**o** 5/25

NE/BI



GR/AR



BI/BL



BL/BI



AZ/BL



RO/BL



RO/BI



AR/BI



BO/BI



VE/BI



## POLO IN PIQUET 3 BOTTONI



RY/BI





**AY 7437  
SKIPPER LADY**

Polo donna sfiancata manica corta con 5 bottoni bianchi, collo e bordo manica con fine profilo a contrasto, colletto e bordo manica a costine, spacchetti laterali con cucitura di rinforzo, cuciture del collo coperte, nastro di rinforzo laterale, cuciture stretch, rinforzo sagomato retrocollo; 100% cotone piquet.

CE I CAT

Cotone Piquet - 210 g/mq

S - M - L - XL

5/25



BI/BL



RO/BI



NE/FX



NE/BI



RO/BI



VE/BI



GR/AR



BO/BI



BI/BL





## AY 7421 NATION

Polo da uomo manica corta con 3 bottoni in tinta ad effetto perlato, colletto da un lato in tinta, dall'altro lato a contrasto con colori bandiera tricolore visibile solo se alzato, bordo manica dx con fine inserto colore bandiera in contrasto, colletto e bordo manica a costine, spacchetti laterali con colore bandiera, cuciture del collo coperte con nastro in jersey colori bandiera, nastro di rinforzo laterale, rinforzo sagomato retrocollo; 100% cotone piquet.

CE I CAT

 Cotone Piquet - 210 g/mq

 S - M - L - XL - XXL - 3XL  
(Bianco, Blu, Nero disponibili anche 4XL e 5XL)

 5/25



# POLO UOMO

## 3 BOTTONI SPACCHI LATERALI

RETRO COLLETTO **TRICOLORE**

RY





**AY 7422  
NATION LADY**

Polo sfiancata da donna a manica corta con 5 bottoni in tinta ad effetto perlato, colletto da un lato in tinta, dall'altro lato a contrasto con colori bandiera visibile solo se alzato, bordo manica dx con fine inserto colori bandiera in contrasto, colletto e bordo manica a costine, spacchetti laterali colori bandiera, cuciture del collo coperte con nastro in jersey colori bandiera, nastro di rinforzo laterale, rinforzo sagomato retrocollo; 100% cotone piquet.

CE I CAT

Cotone Piquet - 210 g/mq

S - M - L - XL

5/25



**POLO  
DONNA**  
5 BOTTONI  
TAGLIO  
SFIANCATO

RETRO  
COLLETO  
**TRICOLERE**



A man and a woman are sitting at a table outdoors, smiling and waving. They are wearing white polo shirts with nautical-style stripes on the collar and sleeves. In front of them are two drinks: a blue one and a pink one, both with pink straws. Behind them is a large red and white A&W logo. The scene is bright and sunny.

**NAUTIC  
LADY**

**NAUTIC  
UOMO**



**AY 7418  
NAUTIC LADY**

Polo sfiancata da donna manica corta con 6 bottoni in tinta effetto perlato, colletto da un lato con righe a contrasto e dall'altro con righe fluorescenti visibili solo se alzato, colletto e bordo maniche a costine, la destra con fine inserto, spacchetti laterali e cuciture del collo coperte con nastro fluo, etichetta transfer; 100 % cotone jersey slub yarn.

CE I CAT

i Cotone Jersey - 160 g/mq

S - M - L - XL

5/50



**6  
BOTTONI**

**NASTRO FLUO SU COLLO E SPACCHETTI**



**AY 7416  
NAUTIC**

Polo da uomo manica corta con 3 bottoni in tinta effetto perlato, colletto da un lato con righe a contrasto e dall'altro con righe fluorescenti visibili solo se alzato, colletto e bordo maniche a costine, la destra con fine inserto, spacchetti laterali e cuciture del collo coperte con nastro fluo, etichetta transfer; 100 % cotone jersey slub yarn.

CE I CAT

i Cotone Jersey - 160 g/mq

S - M - L - XL - XXL - 3XL

5/50

**3  
BOTTONI**





**AY 7489  
VENICE KIDS**

Polo da bambino in cotone 100% a manica corta con 3 bottoni in tinta effetto perlato, colletto e bordo manica a costine, spacchetti laterali, cuciture del collo coperte con nastro a contrasto, cuciture stretch, nastro di rinforzo laterale, rinforzo sagomato retrocollo.

CE I CAT

**i** Cotone Piquet - 200 g/mq

**⊘** XS(3/4) - S(5/6) - M(7/8)  
L(9/10) - XL(11/12) -  
XXL(13/14)

**🕒** 5/50



**POLO 3  
BOTTONI  
SPACCHETTI  
LATERALI  
CUCITURE  
STRECHT**



AQ







**AY 7514  
FLORENCE KIDS**

Polo a manica lunga in cotone piquet 100% con apertura a 3 bottoni in tinta, spacchetti laterali e lunetta dietro collo.

CE I CAT

**i** Cotone Piquet - 210 g/mq

**◊** XS(3/4) - S(5/6) - M(7/8)  
L(9/10) - XL(11/12)  
XXL(13/14)

**♻️** 5/50



**FLORENCE  
KIDS**



**POLO  
MANICA  
LUNGA  
3 BOTTONI**





## AY 7434 ITALIA

Polo unisex a manica corta a 3 bottoni in tinta, collo e bordo manica con fine profilo tricolore in contrasto, colletto e bordo manica a costine, spacchetti laterali con cucitura di rinforzo, cuciture del collo coperte, nastro di rinforzo laterale, cuciture stretch, rinforzo sagomato retrocollo; 100% cotone piquet

CE I CAT

 Cotone Piquet - 210 g/mq

 XXS - XS - S - M - L - XL  
XXL - 3XL (Blu Navy, Bianco,  
Rosso, Royal, Nero disponibili  
anche in 4XL e 5XL)

 5/25

NE



ML



BL



BI



VE



VM



RO



RY



# POLO UNISEX

**COLLO E  
GIROMANICA  
TRICOLORE**



## AY 7505 AVIAZIONE

Polo unisex a manica lunga a 3 bottoni in tinta, collo e polsino con fine profilo tricolore in contrasto, colletto e polsino a costine, spacchetti laterali, cuciture del collo coperte, nastro di rinforzo laterale, rinforzo sagomato retrocollo; 100% cotone piquet.

CE I CAT

**i** Cotone Piquet - 210 g/mq

**●** XXS - XS - S - M - L - XL -  
XXL - 3XL - 4XL - 5XL

**🕒** 5/25

## COLLO E POLSINO TRICOLORE



BL



RY



NE



RO



BI



POLO  
UNISEX  
**MANICA  
LUNGA  
3 BOTTONI**



**AY 7515  
FLORENCE**

Polo da uomo a manica lunga con 3 bottoni in tinta effetto perlato, colletto e polsino a costine, spacchetti laterali, cuciture del collo coperte con nastro a contrasto, cuciture stretch, nastro di rinforzo laterale, rinforzo sagomato retrocollo; 100% cotone piquet.

CE I CAT

**i** Cotone Piquet - 210 g/mq

**⊘** XS - S - M - L - XL - XXL - 3XL  
4XL - 5XL

**⊘** 5/50



ML





**AY 7516  
FLORENCE LADY**

Polo sfiancata da donna manica lunga con 4 bottoni in tinta effetto perlato, colletto e bordo maniche a costine, spacchetti laterali, cuciture del collo coperte con nastro a contrasto, cuciture stretch, nastro di rinforzo laterale, rinforzo sagomato retrocollo; 100% cotone piquet.

CE I CAT

i Cotone Piquet - 210 g/mq

XS - S - M - L - XL - XXL

5/50



**POLO  
LADY**  
MANICA  
LUNGA  
**4 BOTTONI**



AR





**AY 7509  
LONG NATION**

Polo da uomo manica lunga con 3 bottoni in tinta ad effetto perlato, colletto da un lato in tinta, dall'altro lato a contrasto tricolore, visibile solo se alzato, interno abbottonatura collo e spacchetti laterali con inserto tricolore, colletto e polsino a costine, cuciture del collo coperte, nastro di rinforzo laterale, rinforzo sagomato; 100% cotone piquet.

CE I CAT

i Cotone Piquet - 210 g/mq

S - M - L - XL - XXL - 3XL - 4XL - 5XL

5/25



**TRICOLORE  
SU RETRO  
COLLETTO**



BI

**POLO  
UOMO  
MANICA  
LUNGA  
3 BOTTONI**

RO



RY



NE



BL



**promo**solution

**FELPE**



## AY 7521 MISTRAL+

Felpe Girocollo, manica raglan, cucitura estetica a V al collo, polsini e vita in costina elasticizzata, cuciture rinforzate. Disponibile anche in versione donna con taglio sfiancato:

**MISTRAL LADY**

CE I CAT

**i** Cotone 70% + Poliestere 30%  
300 g/mq

**S** - M - L - XL - XXL - 3XL  
4XL - 5XL

**5/20**



**DISPONIBILE  
ANCHE LADY**

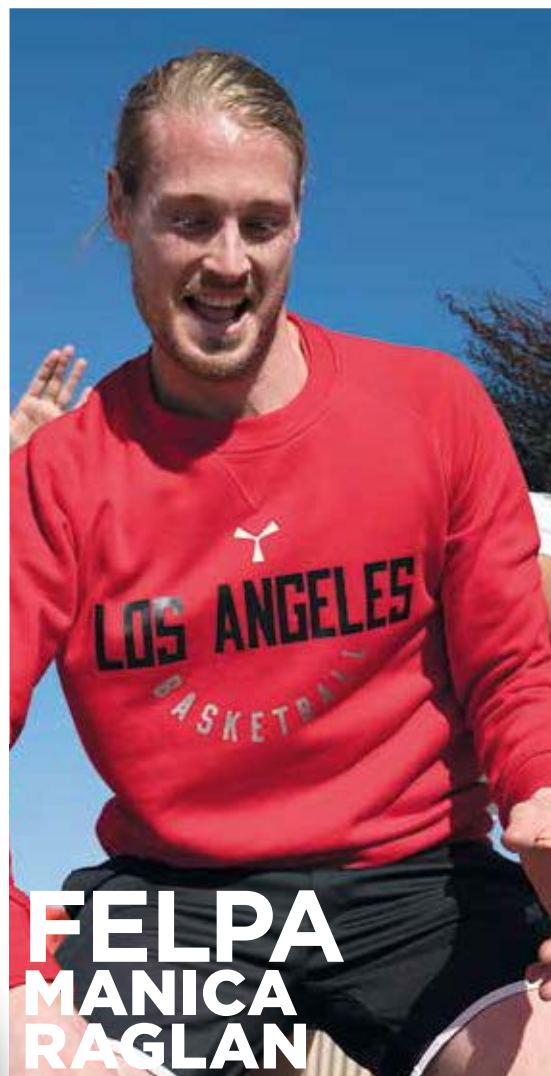





## AY 7524 NEW ORLEANS

Felpe da uomo, girocollo, manica a giro, polsini e vita in costina elasticizzata, cuciture rinforzate.

CE I CAT

**i** Cotone 55% + Poliestere 45%  
260 g/mq

**1** XS - S - M - L - XL - XXL - 3XL -  
4XL - 5XL

**2** 5/20

BL



RY



RO



# FELPA GIROCOLLO POLSINI E VITA ELASTICIZZATI

NE



ML



SM



BI





## AY 7522 ORLANDO

Felpa da uomo, girocollo, cucitura estetica a V al collo, manica a giro, polsini e vita in costina elasticizzata, cuciture rinforzate.

CE I CAT

**i** Cotone 70% + Poliestere 30%  
280 g/mq

**o** XS - S - M - L - XL - XXL - 3XL  
(disponibili anche 4XL - 5XL  
tranne Rossa)

**o** 5/20



# FELPA GIRO COLLO MANICA A GIRO



**CUCITURA  
"V" AL  
COLLO**



RO



### AY 7523 ORLANDO KIDS

Felpe da bambino, girocollo, cucitura estetica a V al collo, manica a giro, polsini e vita in costina elasticizzata, cuciture rinforzate.

**i** Cotone 70% + Poliestere 30%  
280 g/mq

**1** XS (3/4) - S (5/6) - M (7/8)  
L (9/10) - XL (11/12)

**2** 5/20

BL



RY



BA



## FELPA KIDS CUCITURE RINFORZATE

RO



GI



AR



JG





## AY 7525 MIAMI+

Felpa a mezza zip in plastica con cursore in metallo, polsini e vita in costina elasticizzata, doppia cucitura al collo, alle maniche e in vita e nastro di rinforzo al collo. Disponibile anche in versione donna con taglio sfiancato: **MIAMI LADY**

CE I CAT **SBS ZIPPER**

**i** Cotone 70% + Poliestere 30%  
300 g/mq

**XS - S - M - L - XL - XXL - 3XL**  
4XL - 5XL

**5/20**

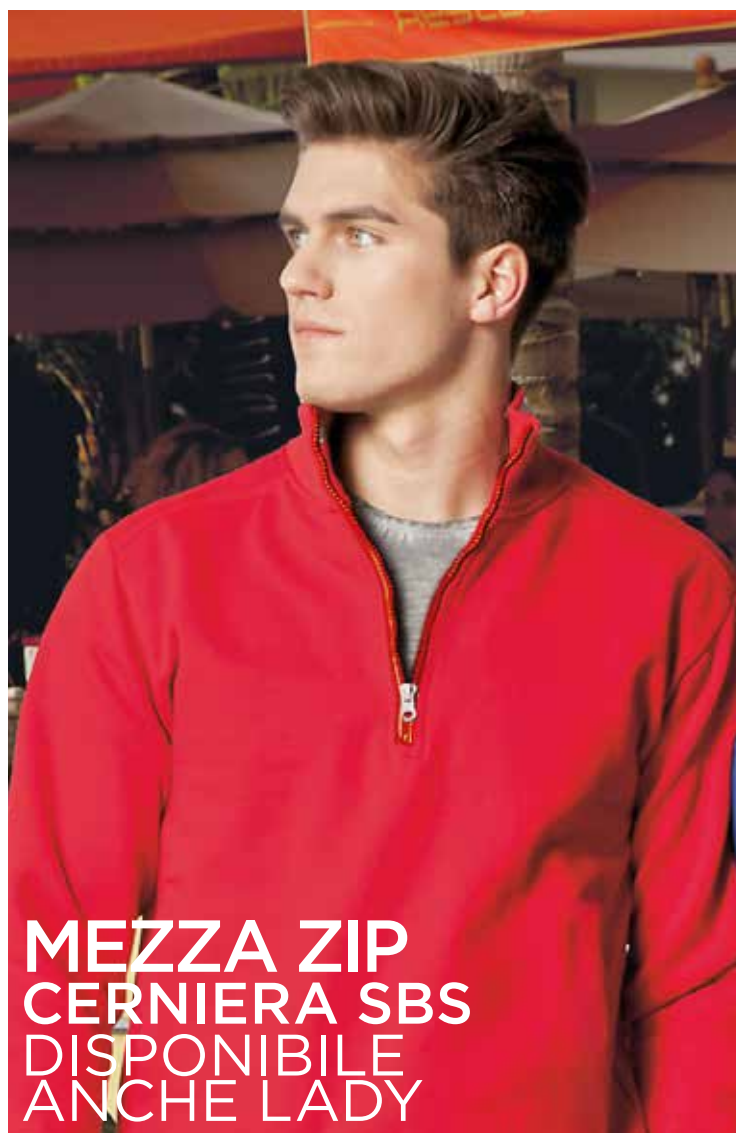

**MEZZA ZIP  
CERNIERA SBS  
DISPONIBILE  
ANCHE LADY**



## AY 7527 CANADA

Felpa da uomo, mezza zip in tinta, in plastica con cursore in metallo, manica a giro, polsini e vita in costina elasticizzata, cuciture rinforzate.

CE I CAT **SBS ZIPPER**

**i** Cotone 70% + Poliestere 30%  
280 g/mq

**S** - M - L - XL - XXL - 3XL  
4XL - 5XL

**5/20**



NE



SM



ML



RO



BL



RY



AR



**CUCITURE  
RINFORZATE**



**AY 7528  
AUSTIN**

Felpa da uomo, mezza zip in tinta, in plastica con cursore in metallo ad effetto gommato, manica raglan, polsini e vita in costina elasticizzata, cucitura rinforzata.



**i** Cotone 100% - 330 g/mq

**XS-S-M-L-XL-XXL-3XL**

**1/20**

**FELPA**  
**MEZZA ZIP**  
**IN TINTA**  
**CERNIERA SBS**



**100% COTONE**





## AY 7529 RIO

Felpa da uomo, mezza zip in plastica in colore a contrasto, cursore in metallo, profilo a contrasto nel colletto e alle tasche laterali. Manica a giro, collo, polsini e vita in costina elasticizzata, cuciture rinforzate.

CE I CAT **SBS ZIPPER**

**i** Cotone 70% + Poliestere 30%  
300 g/mq

**⊘** XS - S - M - L - XL - XXL - 3XL  
4XL - 5XL (4XL - 5XL tutte  
disponibili tranne Rossa)

**⊘** 5/20

# FELPA CON ZIP CERNIERA SBS COLLO E POLSINI A CONTRASTO

VITA, COLLO  
E POLSINI  
ELASTICIZZATI

RO

BL



RY



NE



GR





## AY 7545 PANAMA+

Felpa da uomo a manica raglan e zip intera in tinta, doppio cursore in metallo; due tasche con zip coperte, polsini e vita in costina elasticizzata, cuciture rinforzate. Disponibile anche in versione donna con taglio sfiancato: **PANAMA+ LADY**



**i** Cotone 70% + Poliestere 30%  
300 g/mq

**XS - S - M - L - XL - XXL - 3XL**  
4XL - 5XL

**5/20**

NE



ML



BL



RY



**FELPA CON ZIP INTERA  
DOPPIO CURSORE  
POLSINI E VITA  
ELASTICIZZATA  
DISPONIBILE ANCHE LADY**

VE



RO



AR



SM



BI







## AY 7542 HOUSTON

Felpa con zip intera in plastica in tinta, cursore in metallo; polsini e vita in costina elasticizzata, cuciture rinforzate. Nastro di rinforzo interno collo in tinta.

CE I CAT **SBS  
ZIPPER**

**i** Cotone 70% + Poliestere 30%  
280 g/mq

**⊘** XS - S - M - L - XL - XXL  
3XL - 4XL - 5XL

**⊘** 5/20

# FELPA CON ZIP INTERA E CURSORE IN METALLO RINFORZO INTERNO COLLO



NE





## AY 7530 SYDNEY

Felpa da uomo, zip intera SBS in plastica in colore a contrasto, con doppio cursore in metallo. Colletto in rib con profilo a contrasto anche alle tasche laterali, manica a giro, due tasche esterne con zip a contrasto, polsini e vita in costina elasticizzata. Cuciture rinforzate.



**i** Cotone 70% + Poliestere 30%  
300 g/mq

**⊘** XS - S - M - L - XL - XXL - 3XL  
(Bianco, Blu, Royal, Melange,  
Smoke, Nero disponibili anche  
4XL-5XL)

**⊘** 5/20



## FELPA CON ZIP INTERA DOPPIO CURSORE



GF



RO



BI



ML



SM



NE



BL



RY



### AY 7532 NAZIONALE

Felpa a zip intera con contrasto tricolore e doppio cursore; colletto in rib con tricolore a contrasto all'interno, due tasche esterne, rib in vita, doppia cucitura al collo, alle maniche e in vita e nastro di rinforzo al collo.



**i** Cotone 70% + Poliestere 30%  
300 g/mq

**XS - S - M - L - XL - XXL - 3XL**

**5/20**



**FELPA CON  
TRICOLORE  
SU ZIP  
E COLLO**  
**2 TASCHE  
ESTERNE**





## AY 7548 ATLANTA+

Felpa da uomo, cappuccio a due cuciture, coulisse bianca in corda con cuciture in tinta con la felpa e anelli in metallo, manica raglan, cucitura estetica a V al collo, tasche a marsupio, taschino con zip, polsini e vita in costina elasticizzata, cuciture rinforzate. Disponibile anche in versione donna con taglio sfiancato:

**ATLANTA+ LADY**

**CE** I CAT

**i** Garzato 70% + Poliestere 30%  
300 g/mq

**o** XS - S - M - L - XL - XXL - 3XL  
(Bianco, Blu, Royal, Melange,  
Smoke, Nero disponibili anche  
4XL-5XL)

**o** 5/20



## FELPA ATLANTA

**DISPONIBILE  
ANCHE LADY**



RY





## AY 7550 TORONTO

Felpe da uomo, cappuccio con coulisse in tinta, cucitura estetica a V al collo, tasche a marsupio, manica a giro, polsini e vita in costina elasticizzata, cuciture rinforzate. Nastro di rinforzo interno collo in tinta.

CE I CAT

**i** Cotone 70% + Poliestere 30%  
280 g/mq

**XS - S - M - L - XL - XXL - 3XL**  
**4XL - 5XL**

**5/20**



## FELPA CON CAPPuccio TASCHE A MARSUPIO





## AY 7535 DALLAS+

Felpa da uomo, zip intera SBS coperta, in plastica con doppio cursore in metallo, cappuccio con due cuciture, coulisse bianca in corda con cuciture in tinta con la felpa e anelli in metallo, manica raglan, tasche a marsupio con taschino con zip, polsini e vita in costina elasticizzata. Cuciture rinforzate. Disponibile anche in versione donna con taglio sfiancato: **DALLAS+ LADY**.



**i** Cotone 70% + Poliestere 30%  
300 g/mq

**XS - S - M - L - XL - XXL**  
**3XL - 4XL - 5XL**

**5/20**



**FELPA CON  
CAPPUCCIO  
MANICA  
RAGLAN**

BO



RO



AR



MI



**DISPONIBILE  
ANCHE LADY**

NE



SM



BL



RY



VE



ML





## AY 7534 PORTLAND

Felpa da uomo, zip intera in plastica a cursore singolo in metallo, cappuccio, coulisse in corda con cuciture in tinta con la felpa e anelli in metallo, manica a giro, tasche a marsupio, polsini e vita in costina elasticizzata. Cuciture rinforzate, nastro di rinforzo interno collo in tinta.

CE I CAT **SBS  
ZIPPER**

**i** Cotone 70% + Poliestere 30%  
280 g/mq

**⊘** S - M - L - XL - XXL - 3XL  
(4XL-5XL tutte disponibili  
tranne Rossa)

**⊘** 5/20



## FELPA CON CAPPUCCIO

**POLSINI E VITA  
ELASTICIZZATI  
TASCHE A  
MARSUPIO**



RO

ML



NE



SM



BL



RY





## AY 7554 WORK 2.0

Felpa da uomo, zip intera SBS in plastica con cursore in metallo "autolock", due tasche con cerniera, una tasca multifunzione al petto con porta badge a scomparsa e patta di chiusura LOCK SYSTEM, bande riflettenti alle spalle, polsini e vita in costina elasticizzata, doppia cucitura al collo, alle maniche e in vita e nastro di rinforzo al collo. Trattamento del tessuto water repellent.

CE I CAT



SBS  
ZIPPER

**i** Cotone 70% + Poliestere 30%  
300 gv/mq

**XS - S - M - L - XL - XXL**  
**3XL 4XL - 5XL**

**5/20**

RO



SM



NE



## BANDE RIFLETTENTI SULLE SPALLE CHIUSURA LOCK SYSTEM

BL



RY



**WATER  
REPELLENT**





## AY 7552 HAWAII+

Felpa da uomo, zip intera SBS coperta con doppio cursore in metallo, cappuccio con due cuciture, coulisse bianca con cuciture in tinta con la felpa e anelli in metallo, manica raglan, tasche a marsupio con taschino con zip, polsini e vita in costina elasticizzata. Cuciture rinforzate. Disponibile anche in versione donna con taglio sfiancato:

**HAWAII+ LADY**



**i** Cotone 80% + Poliestere 20%  
260 g/mq

**S - M - L - XL - XXL - 3XL**

**5/20**



NE



BL



SM

## FELPA CON CAPPuccio ZIP DOPPIO CURSORE DISPONIBILE ANCHE LADY



RY



BI

**TASCHINO  
SECUR-ZIP**



## AY 7556 SEATTLE

Pantalone da uomo in felpa, rib elasticizzato in vita e a fondo gamba, zip con patta, coulisse bianca in corda con cuciture in contrasto e anelli in metallo, due tasche frontali con rib e un taschino dietro, patta con zip e cuciture rinforzate.

CE I CAT

**i** Cotone 70% + Poliestere 30%  
300 g/mq

**S** - M - L - XL - XXL - 3XL

**5/20**



## PANTALONE UOMO IN FELPA 2 TASCHE

VITA E FONDO GAMBE ELASTICIZZATI



## AY 7557 SEATTLE LADY

Pantalone da donna in felpa, rib elasticizzato in vita e a fondo gamba, coulisse bianca in corda con cuciture in contrasto e anelli in metallo, due tasche frontali con rib e cuciture rinforzate.

CE I CAT

**i** Cotone 70% + Poliestere 30%  
300 g/mq

**XS** - S - M - L (Blu Navy è disponibile anche XL)

**5/20**



## PANTALONE LADY IN FELPA 2 TASCHE

**promo**solution

**PILE**



## AY 7560 DOLOMITI +

Pile, mezza zip 8mm in plastica nera, manica raglan, coulisse regolabile in vita, elastici stringi polso, due tasche con zip coperte, una tasca frontale con zip, collo con bordatura di rinforzo in contrasto, cuciture rinforzate.

CE I CAT

 Poliestere - 280 g/mq

 XS - S - M - L - XL - XXL - 3XL  
(Bianco, Blu, Royal e Nero disponibili anche 4XL e 5XL)

 5/20



## PILE MEZZA ZIP ELASTICI STRINGIPOLSO



GI





**AY 7567  
PIRENEI**

Pile, mezza zip 8mm in plastica nera, manica a giro, elastici stringi polso e in vita, due tasche con zip coperta, una tasca frontale con zip, collo con bordatura di rinforzo in contrasto, cuciture rinforzate.

CE I CAT

 Poliestere - 280 g/mq

 XS - S - M - L - XL - XXL - 3XL  
4XL-5XL

 1/10

**PILE  
MEZZA ZIP  
ELASTICO  
POLSO E VITA  
3 TASCHE  
CON ZIP**

AR



BL



NE



SG





## AY 7566 NEPAL

Pile, zip intera in nylon cursore singolo, manica a giro, elastici stringi polso e in vita, due tasche con zip coperta, cuciture rinforzate, fondo dritto.

CE I CAT

 Poliestere - 280 g/mq

 XS - S - M - L - XL - XXL - 3XL  
(4XL e 5XL tutte disponibili  
tranne Arancione)

 5/20

SG



NE



VE



BL



**PILE CON  
ZIP INTERA  
IN TINTA**

RY



RO



AR





## AY 7561 ASPEN +

Pile bicolore uomo, zip intera 8mm in plastica nera, manica raglan, coulisse regolabile in vita, elastici stringi polso, due tasche con zip coperte, una tasca frontale con zip, collo con bordatura di rinforzo in contrasto, cuciture rinforzate. Disponibile anche in versione donna con taglio sfiancato: **ASPEN+ LADY**.

CE I CAT

 Pile Antipilling - 280 g/mq

 S - M - L - XL - XXL - 3XL  
4XL - 5XL

 5/20

NE/GR



GR/AR



**FIANCHI  
BICOLORE  
FULL ZIP  
3 TASCHE  
DISPONIBILE  
ANCHE LADY**

VE/VA



BL/RV



RV/NE



RO/NE





**AY 7568  
EASY+**

Gilet in pile da uomo, zip intera 8mm in plastica doppio cursore, taglio raglan, due tasche frontali con zip coperta e una tasca al petto con zip. Disponibile anche in versione donna: **EASY+ LADY.**

CE I CAT

i Poliestere - 280 g/mq

S - M - L - XL - XXL - 3XL

1/20

**GILET PILE  
ZIP INTERA  
3 TASCHE  
CON ZIP**



BL



NE





**promo**solution

**GIUBBINI**



## AY 7260 NORTH 2.0

Giubbino da uomo, zip da 8mm, in plastica con cursore in metallo, con polsini e vita in rib elasticizzato, due tasche esterne con zip coperta. Interno: imbottito, micropile nel colletto e schiena, una tasca con cerniera porta smartphone con predisposizione per cavo, zip al petto e schiena per agevolare stampe e ricami. Disponibile in versione donna: **NORTH 2.0 LADY** ed in versione bambino: **NORTH 2.0 KIDS**

CE I CAT



**i** Nylon Taslon 288T - 105 g/mq

**o** XS - S - M - L - XL - XXL - 3XL  
(4XL - 5XL disponibili solo in Blu Navy, Nero e Smoke)

**o** 1/10



GIUBBINO IMBOTTITO CON  
TASCA PER SMARTPHONE







DISPONIBILE  
ANCHE  
**LADY E KIDS**

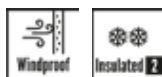

## AY 7236 FREETIME

Giubbino/piumino da uomo con cappuccio, zip 5mm in plastica con cursore in metallo, fine bordino ai polsi e in vita, due tasche esterne. Interno: imbottito di poliestere effetto piuma, due tasche.



-  Nylon 320T - 58 g/mq
-  XS - S - M - L - XL - XXL - 3XL
-  1/10



# GIUBBINO PIUMINO CON CAPPuccio



BL



NE



## AY 7255 NORTH R 2.0

Giubbino da uomo, zip in contrasto, in plastica con cursore in metallo, con polsini e vita in rib elasticizzato, due tasche esterne con zip coperta. Interno: imbottito, micropile nel colletto e schiena, una tasca con cerniera porta smartphone con predisposizione per cavo, zip al petto e schiena per agevolare stampe e ricami.

CE I CAT



**i** Nylon Taslon 288T- 105 g/mq

**XS - S - M - L - XL - XXL - 3XL**

**1/10**

## GIUBBINO CON ZIP A CONTRASTO VITA & POLSI ELASTICIZZATI

NE



BL





## AY 7254 SAILING R 2.0

Giubbino da uomo, zip da 8mm in contrasto, cappuccio sagomato con due cuciture e coulisse, elastico in vita, polsini con elastico e stringi polsi gommati di regolazione, due tasche esterne con zip coperta. Interno imbottito, micropile nel colletto e schiena, una tasca con cerniera porta smartphone con predisposizione per cavo, zip al petto e schiena per agevolare stampe e ricami.

CE I CAT



**i** Nylon Taslon 288T- 105 g/mq

**XS - S - M - L - XL - XXL - 3XL**

**1/10**

# GIUBBINO CON CAPPUCCIO STRINGI POLSI GOMMATI



NE



BL



## AY 7230 ESCAPE

Giubbino da uomo, maniche staccabili, zip 8 mm in plastica con cursore in metallo, cappuccio richiudibile nel colletto, elastico e stringi polsi, due ampie tasche frontali LOCK SYSTEM, due tasche laterali, porta smartphone al petto. Interno: imbottito, zip per agevolare stampe e ricami.

CE I CAT



**i** Pongee Ripstop 240T  
Poliestere - 200 g/mq

**XS - S - M - L - XL - XXL - 3XL  
4XL - 5XL**

**1/10**

NE



## GIUBBINO CON MANICHE STACCABILI

## TASCHE LOCK SYSTEM



SM



BL



RY





## AY 7233 RENEGADE

Giubbino unisex, zip 8mm in plastica con cursore in metallo, cappuccio richiudibile nel colletto, elastico e stringi polsi, due ampie tasche frontali LOCK-SYSTEM, due tasche laterali, porta cellulare al petto. Interno: imbottito, zip per agevolare stampe e ricami.

CE I CAT



**i** Pongee Ripstop 240T  
Poliestere - 200 g/mq

**◊** XS - S - M - L - XL - XXL - 3XL  
4XL - 5XL

**☼** 1/10

## GIUBBINO UNISEX CAPPUCCIO NEL COLLETTA





## AY 7251 FIGHTER 2.0

Giubbino da uomo, maniche staccabili, zip 8 mm in plastica con cursore in metallo con patta e bottoni in plastica, retro sagomato e con cappuccio richiudibile nel colletto, due tasche esterne LOCK SYSTEM e due con zip, inclinazione delle tasche per agevolare l'ingresso della mano, una tasca al petto porta smartphone e anello porta badge, bande riflettenti sulla tasca e schiena. Interno: imbottito, pile in contrasto su schiena e collo, una tasca, zip interna per agevolare stampe e ricami.

CE I CAT

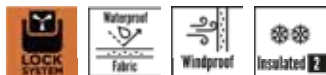

**i** Pongee Ripstop 240T  
Poliestere - 200 g/mq

**S** - M - L - XL - XXL - 3XL - 4XL  
5XL (XS disponibili solo Blu e Nero)

**1/10**

BL/RO



**TASCHE  
LOCK SYSTEM  
MANICHE  
STACCABILI**



BL/RY

SM/NE



NE/SG







## AY 7248 WARM 2.0

Giubbino da uomo, maniche staccabili, retro sagomato, zip da 8 mm in plastica con cursore in metallo, con cappuccio a scomparsa, due ampie tasche esterne con zip, ampia tasca al petto multifunzione e porta smartphone con bande riflettenti, anello porta badge. Interno: imbottitura trapuntata e rifinito con fodera ad alta densità, interno colletto in pile, una tasca.

CE I CAT



**i** Poliestere 80% + Cotone 20%  
170 g/mq

**S** - M - L - XL - XXL - 3XL  
4XL - 5XL

**1/10**

# GIUBBINO TRAPUNTATO CON BANDE RIFLETTENTI

BL



SM



**MANICHE  
STACCABILI**

## AY 7228 GIACCA SOFT-SHELL

Giacca con cappuccio staccabile, coulisse elasticizzata, maniche con regolazioni a velcro, tasca sul petto, due tasche anteriori con zip. Outshell: 96% soft shell e poliestere 4% Elastane. Membrana TPU 8000 mm impermeabile, traspirabilità di 1000 g/mq/24h traspirabilità 3. Fodera in pile.



**i** Poliestere 96% + Elastane 4%

**S - M - L - XL - XXL - 3XL**

**1/10**

# SOFT-SHELL

## MANICHE REGOLABILI CON VELCRO

## 3 TASCHE CON ZIP

## CAPPUCCIO STACCABILE



BL



NE



RO



## AY 7231 PERFORMER 2.0

Giacca ergonomica da uomo, manica giro, zip intera SBS in plastica con cursore in metallo autolock, due tasche laterali con cerniera, una tasca multifunzionale al petto con porta badge a scomparsa e patta di chiusura LOCK SYSTEM, bande riflettenti 3M alle spalle, elastico e stringipolso in velcro, cappuccio amovibile e con coulisse in elastico regolabile con stopper.

CE I CAT

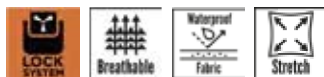

**i** Poliestere 93% + Elastane 7%  
Soft-shell - 330 g/mq

**o** XS - S - M - L - XL - XXL - 3XL  
4XL-5XL

**o** 1/10



## GIACCA ERGONOMICA CAPPUCCIO AMOVIBILE BANDE RIFLETTENTI 3M





## AY 7232 PERTH

Giacca ergonomica da uomo a due strati con trattamento water repellent, manica a giro, zip lunga SBS nastrata, fine bordino elasticizzato ai polsi, 2 tasche laterali con zip. Disponibile nella versione donna: **PERTH LADY**

CE I CAT



**i** Poliestere - 280 g/mq

**S** - M - L - XL - XXL - 3XL  
4XL - 5XL

**1/20**



RY



**SOFT-SHELL  
WATER  
REPELLENT  
ZIP LUNGA SBS**



## AY 7223 GALE

Giacca ergonomica da uomo, manica raglan, cappuccio sagomato con due cuciture e coulisse, zip lunga nastrata, elastico e stringipolso in velcro, due tasche esterne con zip. Disponibile nella versione donna con taglio sfiancato: **GALE LADY** e versione da bambino: **GALE KIDS**

CE I CAT



**i** Poliestere - 320 g/mq

**XS - vS - M - L - XL - XXL - 3XL  
4XL - 5XL**

**1/50**



**DISPONIBILE  
ANCHE  
LADY E KIDS**



SG





## AY 7237 STORM

Giacca ergonomica da uomo bicolore, zip lunga SBS nastrata, cappuccio richiudibile nel colletto, polsini regolabili con stringi polso gommati e velcro, due tasche laterali con zip, una tasca al petto con porta badge a scomparsa, una tasca skipass al braccio, coulisse in vita. Una tasca interna e due zip per agevolare stampa e ricami al petto e alle spalle.

CE I CAT SBS ZIPPER

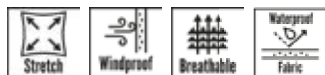

**i** Poliestere 93% + Elastan 7%  
330 g/mq

**XS - S - M - L - XL - XXL**  
**3XL - 4XL - 5XL**

**1/10**

RY/NE



BL/RY



NE/GI



SG/NE



## SOFT-SHELL BICOLORE CAPPUCCIO RICHIUDIBILE POLSINI REGOLABILI

BI/GR



RO/NE

VE/NE





## AY 7235 EXTREME

Giacca ergonomica da uomo, manica raglan, cappuccio sagomato con due cuciture e coulisse, zip lunga SBS nastrata, polsini regolabili con stringi polso gommati e velcro, fine bordino ai polsi e in vita, due tasche laterali con zip, una tasca al petto e una tasca al braccio sinistro. Disponibile in versione da donna: **EXTREME LADY**

CE I CAT



**i** Poliestere - 280 g/mq

**o** XS - S - M - L - XL - XXL  
3XL - 4XL - 5XL

**o** 1/10



**MANICA RAGLAN**  
**ZIP LUNGA**  
**CAPPUCCIO**  
**SAGOMATO**  
**DISPONIBILE**  
**ANCHE LADY**

BI/NE



# GIUBBINI

## AY 7267 RAIN JACKET

Giacca cerata a collo alto con cerniera lunga. Cappuccio ripiegabile a scomparsa nel colletto con cordoncini. Due tasche con copritasca e cerniera. Polsini elastici. Parte inferiore con cordoncini regolabili e stopper.

 Poliestere - 70g/mq

 S - M - L - XL - XXL

 1/50



GIACCA  
CERATA  
ZIP INTERA  
CAPPUCCIO A  
SCOMPARSA



**promo**solution

**GILET**



**MIG2.0  
GILET**



## AY 7201 MIG 2.0

Gilet unisex, zip 8mm in plastica con cursore in metallo con patta e bottoni in plastica, retro sagomato, due tasche esterne LOCK SYSTEM e due con zip, inclinazione delle tasche per agevolare l'ingresso della mano, una tasca al petto porta smartphone e anella porta badge, bande riflettenti sulla tasca e schiena. Interno: imbottito, pile in contrasto su schiena e collo, una tasca, zip interna per agevolare stampe e ricami.

CE I CAT



**i** Pongee Ripstop 240t  
Poliestere - 200 g/mq

**⊖** XS - S - M - L - XL - XXL - 3XL  
(4XL - 5XL disponibili solo  
in Smoke, Blu Navy e Nero)

**⊖** 1/10

NE



SM-NE



GR-AR



BL-RO



BL-RY



RY



BO



RO



AR



VE



**GILET IMBOTTITO  
CON BANDE  
RIFLETTENTI  
INTERNO PILE  
A CONTRASTO**



## AY 7140 WANTED

Gilet unisex, zip da 8 mm in plastica con cursore in metallo, due ampie tasche frontali LOCK SYSTEM, due tasche laterali, porta smartphone al petto. Interno imbottito, zip per agevolare stampe e ricami.

CE I CAT



**i** Pongee Ripstop 240t  
Poliestere - 200 g/mq

**XS - S - M - L - XL - XXL - 3XL**

**1/10**

**ISOLAMENTO  
TERMICO**  
TASCHE FRONTALI  
LOCK-SYSTEM  
**TASCA PER  
CELLULARE**



NE



## AY 7145 DAYTONA

Gilet unisex, zip 8mm in plastica con cursore in metallo, due tasche laterali con zip, una tasca al petto. Interno: imbottito in micropile in contrasto.

CE I CAT



**i** Pongee Ripstop 240t  
Poliestere - 200 g/mq

**S - M - L - XL - XXL - 3XL**

**1/10**





## AY 7200 MEMORY

Gilet da uomo in poliestere imbottito effetto piuma, zip in plastica coperta a, due tasche esterne con zip coperte, interno in colore contrasto.

CE I CAT



**i** Poliestere Memory - 56 g/mq

**◉** XS - S - M - L - XL - XXL - 3XL

**⌚** 1/10

NE/GR



SM/NE



BL/RV



## GILET IN POLIESTERE IMBOTTITO

RO/NE



RY/NE



**ZIP E TASCHE  
COPERTE**



### AY 7150 STAR

Gilet trapuntato con retro sagomato e imbottitura trapuntata, rifinito con fodera ad alta densità, interno colletto in pile. Due ampie tasche con zip, tasca porta cellulare al petto e una tasca interna.

CE I CAT



**i** Pongee Pvc 190t Poliestere  
180 g/mq

**S** - M - L - XL - XXL - 3XL

**1**/10



# GILET TRAPUNTATO COLLETO IN PILE



SM





## AY 7219 AIRSPACE 2.0

Gilet unisex, zip 8 mm in plastica con cursore in metallo, retro sagomato, due ampie tasche esterne con zip, ampia tasca al petto porta smartphone, anello porta badge, piping reflex al petto e sulla schiena. Interno: imbottitura trapuntata e rifinita con fodera ad alta densità, interno colletto in pile, una tasca interna.

CE I CAT



**i** Pongee Pvc 190t Poliestere  
180 g/mq

**S** - M - L - XL - XXL - 3XL  
(4XL-5XL tutte disponibili  
tranne Bianco)

**1/10**







## AY 7210 RADAR 2.0

Gilet unisex, zip 5mm in plastica con cursore in metallo, retro sagomato, due ampie tasche esterne con zip, piping reflex al petto e sulla schiena. Interno: imbottitura trapuntata e rifinita con fodera ad alta densità, interno colletto in pile, una tasca interna.

CE I CAT



**i** Pongee Pvc 190t Poliestere  
180 g/mq

S - M - L - XL - XXL - 3XL

1/10

# GILET UNISEX RETRO SAGOMATO FODERA ALTA DENSITÀ



NE



BL



## AY 7226 GLASGOW SOFT-SHELL UOMO

Gilet ergonomico a due strati e trattamento water repellent, con zip lunga, due tasche laterali con zip, una tasca al petto, coulisse in vita.

CE I CAT



**i** Soft Shell Mechanical Stretch  
Poliestere - 320 g/mq

**◊** XS - S - M - L - XL - XXL  
3XL - 4XL - 5XL

**☑** 1/20



## AY 7227 GILET SOFT-SHELL DONNA

Gilet con due tasche anteriori con zip più una tasca sul petto. Outshell. Membrana TPU 8000 mm impermeabile, traspirabilità di 1000 g/mq/24h 3. Fodera in pile.

CE I CAT



**i** Soft-shell Poliestere 96%  
+ Elastane 4%

**◊** S - M - L - XL - XXL

**☑** 1/10





## AY 7221 HORIZON R 2.0

Gilet da uomo, zip da 8 mm a contrasto, due tasche esterne con zip coperta. Interno: non imbottito, retinato, una tasca con cerniera e predisposizione per cuffie e cavo smartphone zip al petto e sul fondo per agevolare stampe e ricami. Disponibile in versione da donna:

**HORIZON LADY R 2.0**

CE I CAT



**i** Taslon nylon- 105 g/mq

**XS - S - M - L - XL - XXL - 3XL**

**1/10**



**GILET LEGGERO  
NON IMBOTTITO  
ZIP A CONTRASTO**



## AY 7185 SOUTH R 2.0

Gilet unisex, zip da 8mm a contrasto, elastico in vita, due tasche esterne con zip coperta. Interno: imbottito, micropile nel colletto e nella schiena, una tasca con cerniera e cavo smartphone, zip al petto e sul fondo per agevolare stampe e ricami.

CE I CAT

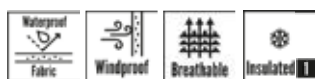

**i** Taslon Nylon - 105 g/mq

**/** XS - S - M - L - XL - XXL - 3XL

**/** 1/10

## GILET UNISEX ZIP A CONTRASTO INTERNO IMBOTTITO

BL



NE





## AY 7180 SPEED

Gilet unisex reversibile, zip in plastica coperta con profilo reflex, coulisse in vita, tre tasche esterne. Interno: in pile, colletto in rib a maglia, due tasche e zip al petto per agevolare stampe e ricami.

CE I CAT



**i** Pongee Pvc 190t Poliestere  
180 g/mq

**/** S - M - L - XL - XXL

**1/20**

# GILET UNISEX REVERSIBILE ZIP COPERTA CON PROFILO IN REFLEX

NE



SM



BL





## AY 7216 POCKET

Gilet estivo, zip, composizione multitasche frontale con un porta badge reversibile, piping reflex alle spalle e schiena, ampia cacciatora posteriore. Interno: fodera in dry-tech, in colore a contrasto, aperta per agevolare stampe e ricami.

CE I CAT



**i** Cotone 20% + Poliestere 80%  
190 g/mq

**S - M - L - XL - XXL - 3XL**  
(Blu, Royal, Smoke e Nero  
disponibili anche 4XL e 5XL)

**1/10**

## GILET MULTITASCHE FODERA IN DRY-TECH



RY



**promo**solution

**S P O R T  
W E A R**

**Joma****SH 101953****TUTA  
CHAMPIONCHIP VI**

Tuta a set. Giacca con zip e tasche, rib su polsini, colletto ed elastico in vita per una regolazione ottimale. Pantalone con elastico regolabile in vita mediante lacci, materiale rib nei polsini che fornisce comoda regolazione e tasche laterali. Logo ricamato.

**i** 100% Poliestere - 255 g

**XS - S - M - L - XL - XXL - 3XL**

**1**

**SET TUTA GIACCA E PANTALONI****Joma****SH 100285****FELPA FARAON**

Felpa foderata, caratterizzata dal modello con mezza cerniera. Con rib elastico su polsini e cintura per una migliore adattabilità.

**i** 100% Poliestere

**S - M - L - XL**

**1**

**FELPA CON MEZZA CERNIERA**



# Joma

## SH 102256 GIUBBINO ANORAK TRIVOR

Giubbino lungo 3/4 con tessuto pola all'interno che isola dal freddo e mantiene il calore. Incorpora cappuccio a scomparsa, con lacci. Tasche laterali con chiusura a bottone e una tasca extra interna con chiusura adesiva. Logo ricamato.

**i** 100% Poliestere  
TASLON/PVC/PILE - 130 g

**XS - S - M - L - XL - XXL - 3XL**

**1**



## GIUBBINO CON CAPPuccio A SCOMPARSA



# Joma

## SH 100087 IMPERMEABILE IRIS

Impermeabile con cerniera e taschini, polsini regolabili con elastico per una migliore adattabilità e cappuccio. Interno con tecnologia Micro-Mesh per una migliore traspirabilità e maggiore ventilazione, fattori che aiutano a mantenere costante la temperatura corporea.

**i** 100% Poliestere

**S - M - L - XL**

**1**



## IMPERMEABILE CON INTERNO MICROMESH TRASPIRANTE



**Joma****SH 102741  
SET PHOENIX**

Set due pezzi composto da t-shirt a maniche corte con dettagli a contrasto di colore sulle spalle e sul colletto, e shorts con elastico in vita regolabile tramite cordino.

 Interlock 100% poliestere

 XS - S - M - L - XL - XXL - 3XL

 1

TU/BL

**SET T-SHIRT  
E SHORTS**

GIF/BL



NE/BI



RO/BL



BL/BI



RO/NE



VEF/NE



# Joma

## SH 400234 ZAINO SPORTIVO ESTADIO

Zaino con rinforzo nella scarpa e scarpiera rigida sul fondo. Logo in serigrafia.



-  Poliestere 100%
-  Capacità in litri: 23,8
-  1



# Joma

## SH 400007 BORSONE TRAINING III

Borsone da allenamento e gara, con scomparto interno imbottito. È realizzato in poliammide, una fibra sintetica molto resistente e leggera.





-  Poliestere 100%
-  49 x 48 x 32 cm  
(portascarpe H13 cm)
-  1



# Joma

## SH 400649 PALLONE DALI

Pallone da calcio, in TPU morbido al tatto da 0,2 mm con EVA foam da 1,8 mm. Ciò assicura la durata e la morbidezza della palla. Il pallone è realizzato con cucitura a mano con filo a 5 capi che assicura cuciture di alta qualità e rilegatura resistente. Il sistema di fodera in cotone a 4 strati aumenta la forza, la potenza e il controllo. Superficie a 32 pannelli per un controllo aerodinamico ottimale. Mantiene la sua forma e il peso in tutte le condizioni atmosferiche per le migliori prestazioni.

-  TPU/ EVA foam/cotone
-  TAGLIA 5 - Ø 68/70 cm  
410-450 g
-  TAGLIA 4 - Ø 63,5/66 cm  
350 - 390 g
-  1



## SH 1901 CUFFIA DA PISCINA

In poliestere. Confezione 50 pezzi a colore.

 Poliestere 100%

 50



# CUFFIE DA PISCINA

VE/BI/RO

RY/BI



NE/BI



BI/FX



RO/BI



BL/BI



## effea Sport

### SH 2611 OCCHIALINI JUNIOR

Occhialini nuoto con lenti antifog, monoscocca morbida. Confezione da 12, colori assortiti.

 Silicone

 12



BL



RO



NE

## effea Sport

### SH 2626 OCCHIALINI ADULTO

Occhialini nuoto con lenti antifog, monoscocca morbida. Confezione da 12, colori assortiti.

 Silicone

 12



NE



BL



VE



FX



AZ



**promo**solution

**WORK**



## AY 7343 CAMICE LAB

Camice da uomo, con collo rever classico, chiuso sul davanti con bottoni automatici, abbottonatura coperta, una tasca applicata sul petto con scomparto porta-penna, due tasche applicate alla vita, un taschino per smartphone, carrè schiena liscio, spacco sul retro per agevolare i movimenti, maniche lunghe con elastici stringi polso.

CE I CAT



**i** Cotone 50% +  
Poliestere 50%  
175 g/mq

**42-44-46-48-50-52-54-  
56-58-60-62-64-66**

**1/20**



RY



RETRO



NE



BI



BL



RO



VE



SM



**AY 7344  
CAMICE LAB LADY**

Camice da donna, con collo rever classico, chiuso sul davanti con bottoni automatici, abbottonatura coperta, una tasca applicata sul petto con scomparto porta-penna, due tasche applicate alla vita, un taschino per smartphone, carrè schiena liscio, spacco sul retro per agevolare i movimenti, maniche lunghe con elastici stringi polso.

CE I CAT



**i** Cotone 50% +  
Poliestere 50%  
175 g/mq

**36-38-40-42-44-46-48-50-52-54**

**1/20**



## AY 7340 GREMBIULE UOMO

**i** Cotone 65% + Poliestere 35%  
260 g/mq

**1** 100x86 cm

**10/50**



## AY 7345 GREMBIULE DONNA

**i** Cotone 65% + Poliestere 35%  
260 g/mq.

**1** 57x70 cm

**10/80**





**AY 7342**  
**MARGARITA**

Grebbiule unisex con due tasche frontali, cintura in vita e cintura regolabile intorno al collo.

**i** Poliestere 65% +  
Cotone 35% - 190g/mq

**70 x 90 cm**

**10/50**

# GREMBIULE UNISEX CON DUE TASCHE FRONTALI



## AY 7347 GREMBIULE UOMO

Con finto Gilet con 2 tasconi.

**i** Gabardine in Policotone 65% + Poliestere 35% - 180 g/mq

**100x86 cm**

**10/50**



## GREMBIULI IN STILE GILET

## AY 7350 GREMBIULE DONNA

Con finto Gilet con 2 tasconi.

**i** Gabardine in Policotone 65% + Poliestere 35% - 180 g/mq

**68 x 87 cm**

**10/50**



**AY 7358  
GREMBIULE  
CON TASCONE**

**i** Cotone pesante 100%  
210 g/mq.

**67 x 84 cm**

**10/80**

**AY 7365  
GREMBIULE BIANCO**

Con tascone.

**i** Cotone pesante 100%  
195 g/mq.

**65 x 80 cm**

**10/100**



## AY 7362 MARTINI

Grembiule unisex con due tasche sul davanti e cintura.

**i** Poliestere 65% + Cotone 35%  
190g/mq

**85 x 41 cm**

**10/50**

# GREMBIULE UNISEX CON DUE TASCHE FRONTALI



**AY 7360  
GREMBIULE  
BARMAN**

Con 3 tasche

**i** Cotone 100% - 210 g/mq

**1** 56x36 cm

**2** 10/50



**AY 7341  
MOJITO**

Grembiule unisex con due tasche sul davanti e cintura.

**i** Poliestere 65% +  
Cotone 35% - 190g/mq

**1** 85 x 61 cm

**2** 10/50





# THERMO~~PRO~~

BASE LAYER TECHNOLOGY

## PERFORMANCE

I Thermo Pro Base Layer sono ideati per le attività ad alta intensità nelle temperature da miti a fredde.

Thermo Pro Base Layer are the perfect match for intense activities in mild and cold temperatures.

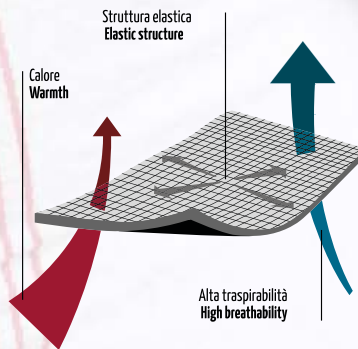

## TECNOLOGIA / TECHNOLOGY

I Thermo Pro Base Layer garantiscono una termoregolazione costante grazie alle speciali tramature e alle eliche a rilievo che permettono una corretta aerazione. I tagli ergonomici assicurano un migliore adattamento alla fisionomia del corpo e libertà di movimento.

The Thermo Pro Base Layer ensure a constant thermoregulation thanks to their special weaves and to the embossed helixes which allow to have a correct ventilation. The ergonomic cuts ensure a better adaptation to the body appearance as well as more freedom of movement.

## GAMMA TERMICA / THERMAL RANGE

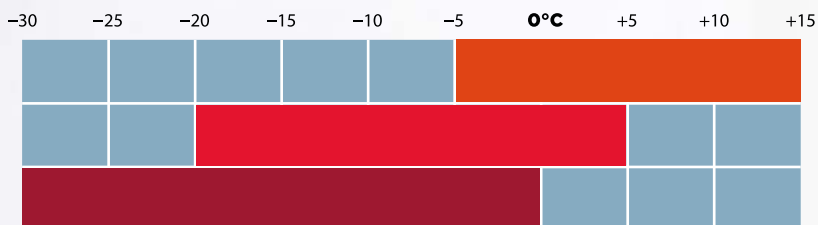



**AY 7285  
THERMO  
PRO 160 SS**

Maglia termica da uomo, girocollo, maniche corte raglan. Tessuto morbido ed elasticizzato, motivi ad elica in rilievo sui fianchi, per garantire una corretta traspirazione ed una costante termoregolazione. Collo, fondo e orli maniche a costine dello stesso materiale, per un miglior comfort. Struttura tubolare ergonomica per assicurare un perfetto adattamento alla fisionomia del corpo.



**i** Poliammide 65% +  
Poliestere 35%  
160 g/mq

**S/M - L/XL - 2/3XL - 4/5XL**

**1/30**

**MANICHE  
RAGLAN**  
STRUTTURA  
TUBOLARE



NE



RY



RETRO



**MAGLIA  
TERMICA  
UOMO**



**AY 7286  
THERMO  
PRO 280 SS**

Maglia termica da uomo, girocollo, maniche corte raglan. Tessuto morbido ed elasticizzato, con speciali tramature sul petto e sulla schiena, motivi ad elica in rilievo sui fianchi, per garantire una corretta traspirazione ed una costante termoregolazione. Collo, fondo e orli maniche a costine dello stesso materiale, per un miglior comfort. Struttura tubolare ergonomica per assicurare un perfetto adattamento alla fisionomia del corpo.



**i** Poliammide 66% +  
Poliestere 26% +  
Elastane 8%  
280 g/mq

**S/M - L/XL - 2/3XL - 4/5XL**

**1/30**

**TESSUTO  
SPECIALE**  
TERMO  
REGOLANTE



**IDEALE PER  
TEMPERATURE  
DA -30° A 0° C**





### AY 7287 THERMO PRO PANT 240 LPANT

Pantaloni termici da uomo, con vita e fondi a costina elasticizzata. Zigrinature sul fronte e sul retro, inserto sotto cavallo, per una perfetta vestibilità anatomica. Tramature sul davanti e retro gambe per garantire una corretta traspirazione nelle zone muscolari.



**i** Poliammide 66% +  
Poliestere 26% +  
Elastane 8%  
240 g/mq

**S/M - L/XL - 2/3XL - 4/5XL**

**1/30**



## PANTALONI **TERMICI** IDEALI PER TEMPERATURE DA **-20° A +5° C**



### AY 7288 THERMO PRO LADY 240 LPANT

Pantaloni termici da donna, con vita e fondi a costina elasticizzata. Zigrinature sul fronte e sul retro, inserto sotto cavallo, per una perfetta vestibilità anatomica. Tramature sul davanti e retro gambe.



**i** Poliammide 66% +  
Poliestere 26% +  
Elastane 8%  
240 g/mq

**XS/S - M/L - XL/XXL**

**1/30**





## AY 7290 THERMO PRO 240 LS

Maglia termica da uomo, girocollo, maniche lunghe raglan. Tessuto morbido ed elasticizzato, con speciali tramature sul petto e sulla schiena, motivi ad elica in rilievo sui fianchi, per garantire una corretta traspirazione ed una costante termoregolazione. Collo, fondo e orli maniche a costine dello stesso materiale, per un miglior comfort. Struttura tubolare ergonomica e speciale zigrinatura sui gomiti, per assicurare un perfetto adattamento alla fisionomia del corpo.



- i** Poliammide 66% +  
Poliestere 26% +  
Elastane 8% - 240 g/mq
- S/M - L/XL - 2/3XL - 4/5XL**
- 1/30**



## AY 7291 THERMO PRO LADY 240 LS

Maglia termica da donna, girocollo, maniche lunghe raglan. Tessuto morbido ed elasticizzato, con speciali tramature sul petto e sulla schiena, motivi ad elica in rilievo sui fianchi, per garantire una corretta traspirazione ed una costante termoregolazione. Collo, fondo e orli maniche a costine dello stesso materiale, per un miglior comfort. Struttura tubolare ergonomica e speciale zigrinatura sui gomiti, per assicurare un perfetto adattamento alla fisionomia del corpo.



- i** Poliammide 66% +  
Poliestere 26% +  
Elastane 8% - 240 g/mq
- XS/S - M/L - XL/2XL**
- 1/30**



**MANICHE  
LUNGHE  
RAGLAN**  
**IDEALI PER  
TEMPERATURE  
DA -20° A +5° C**



**MAGLIA  
TERMICA  
UOMO**



**MAGLIA  
TERMICA  
LADY**





## AY 7289 THERMO PRO 280 LS

Maglia termica da uomo, girocollo, maniche lunghe raglan. Tessuto morbido ed elasticizzato, con speciali tramature sul petto e sulla schiena, motivi ad elica in rilievo sui fianchi, per garantire una corretta traspirazione ed una costante termoregolazione. Collo, fondo e orli maniche a costine dello stesso materiale, per un miglior comfort. Struttura tubolare ergonomica e speciale zigrinatura sui gomiti, per assicurare un perfetto adattamento alla fisionomia del corpo.



**i** Poliammide 66% +  
Poliestere 26% +  
Elastane 8%  
280 g/mq

**S/M - L/XL - 2/3XL - 4/5XL**

**1/30**



## MAGLIA TERMICA UOMO

**IDEALE PER  
TEMPERATURE  
DA -30° A 0° C**



**SPECIALE  
TESSUTO  
TERMO  
REGOLANTE**





## AY 7315 SPECIALIST

Camicia uomo con vestibilità leggermente sfiancata, colletto modello italiano, davanti con cannoncino cucito a vista e bottone bianco effetto perlato, polso sagomato a due bottoni e un'asola; dietro con carrè e pince di ripresa; una tasca tecnica al petto chiusa da patta con bottone e due asole portapenne. Disponibile anche nella versione da donna: **SPECIALIST LADY**

-  Cotone Chambray sanforizzato - 130 g/mq
-  S - M - L - XL - XXL - 3XL  
4XL - 5XL
-  1/20



**TASCA TECNICA +  
ASOLE PORTAPENNE**





**CAMICIE DA LAVORO**



## AY 7337 CHAMBRAY

Camicia manica corta, colletto con button down e due tasche al petto con bottone.

-  Cotone Chambray - 135 g/mq
-  M - L - XL - XXL - 3XL
-  1/20



**2 TASCHE**



**AY 7554  
WORK 2.0**

Felpa da uomo, zip intera SBS in plastica con cursore in metallo "autolock", due tasche con cerniera, una tasca multifunzione al petto con porta badge a scomparsa e patta di chiusura LOCK SYSTEM, bande riflettenti alle spalle, polsini e vita in costina elasticizzata, doppia cucitura al collo, alle maniche e in vita e nastro di rinforzo al collo. Trattamento del tessuto water repellent.

CE I CAT



**i** Cotone 70% + Poliestere 30%  
300 g/mq

**◊** XS - S - M - L - XL - XXL -  
3XL 4XL - 5XL

**⚙** 5/20



**BANDE RIFLETTENTI  
SULLE SPALLE**  
**CHIUSURA LOCK SYSTEM**



**WATER  
REPELLENT**



## AY 7311 NEXT 400

Pantalone unisex, stretch, multistagione, con elastici laterali e passanti in vita, chiusura con zip e bottone personalizzato. Sul davanti ha due tasche sagomate, un taschino porta-monete a destra, un taschino di sicurezza chiuso con zip a sinistra. Sul fronte della gamba sinistra presenta una tasca con soffietto, patta chiusa con velcro e portabadge. Sul fronte della gamba destra sono presenti: un taschino porta-telefono con bordino retroriflettente e una tasca con soffietto. Entrambe le gambe sono dotate di porta-ginocchiere in tessuto a contrasto (con apertura dal basso) e di inserti retroriflettenti che segnalano l'apertura. Sul retro sono presenti: una tasca con pattina chiusa con velcro, una tasca senza pattina ma con 2 bande retroriflettenti, una tasca porta-metro (gamba destra), inserti retroriflettenti all'altezza del ginocchio (entrambe le gambe), battitacco in tessuto a contrasto (entrambe le gambe). Sono inoltre presenti: - cuciture a tre aghi su cavallo, interno ed esterno gamba - travette di rinforzo a contrasto in vari punti. Le taglie (italiane) centrali 48-50-52 hanno un interno gamba regolare di 82 cm.

CE I CAT



**i** Poliestere 50%+ Cotone 30%  
+ Elastomultiestere 20%  
280 g/mq

**1** 42-44-46-48-50-52-54-  
56-58 60-62-64

**2** 1/20

SM/NE



KA/NE



NE/NE



## PANTALONI DI NUOVA GENERAZIONE

VE/NE



BL/NE



RETRO





**AY 7313  
NEXT 4W**

Pantalone unisex, "4 way stretch", multistagione, con elastici laterali e passanti in vita, chiusura con zip e bottone personalizzato. Sul davanti ha due tasche arrotondate, un taschino porta-monete a destra, un taschino di sicurezza chiuso con zip a sinistra. Sul fronte della gamba sinistra presenta 3 tasche: una tasca orizzontale chiusa da una zip, una tasca con patta sagomata chiusa con velcro e dotata di portabadge, una tasca piccola verticale chiusa con zip. Sul fronte della gamba destra è presente una banda retroriflettente. Entrambe le gambe sono dotate di porta-ginocchiere con apertura dall'alto. Sul retro sono presenti: una tasca con pattina chiusa con velcro e una tasca senza pattina ma con 2 bande retroriflettenti, un anello porta martello (gamba destra), una tasca aperta porta-metro (gamba destra) e una tasca porta-telefono con patta e velcro (gamba destra), inserti retroriflettenti all'altezza del ginocchio (entrambe le gambe), battitacco in tessuto a contrasto (entrambe le gambe). Sono presenti anche impunture laterali e travette di rinforzo a contrasto in vari punti. Le taglie (italiane) centrali 48-50-52 hanno un interno gamba regolare di 82 cm.

CE I CAT

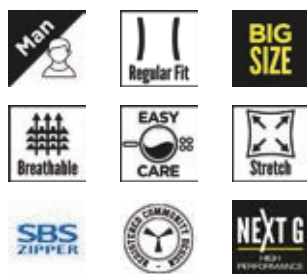

**i** Nylon 90% + Elastan 10%  
260 g/mq

**1** 42-44-46-48-50-52-54-  
56-58 60-62-64

**2** 1/20

SM/NE



BL/NE



AN/NE



ELEVATA ELASTICITÀ

NE/NE



VE/NE



RETRO





## AY 7318 WORKER SUMMER

Pantalone unisex, estivo, elastici laterali e passanti in vita, chiusura con zip e bottone in plastica, due tasche anteriori a taglio classico, una tasca laterale LOCK SYSTEM, un porta metro, due tasche posteriori una aperta e una con patta e velcro, inserti ed impunture a contrasto, bande reflex su tasca posteriore, cuciture triple. Bottone chiodo per il colore bianco. Impunture e cuciture in tono, con travette in contrasto giallo fluo, per il colore Blu Navy DTM.

CE I CAT



**i** Cotone Ripstop 100%  
210 g/mq

**XS - S - M - L - XL - XXL - 3XL  
4XL - 5XL**

**1/20**



## INSERTI E IMPUNTURE A CONTRASTO



## AY 7319 WORKER STRETCH

Pantalone unisex, stretch, multistagione, elastici laterali e passanti in vita, chiusura con zip e bottone in plastica, due tasche anteriori a taglio classico, una tasca laterale LOCK SYSTEM, un porta metro, due tasche posteriori una aperta e una con patta e velcro, cuciture cavallo e interno gamba a triplo ago. Inserti ed impunture a contrasto, bande reflex su tasca posteriore, cuciture triple. Bottone chiodo per il colore bianco. Impunture e cuciture in tono, con travette in contrasto giallo fluo, per il colore Blu Navy DTM.

CE I CAT



**i** Cotone 98% + Elastan 2%  
300 g/mq

**XXS - XS - S - M - L - XL - XXL  
3XL - 4XL - 5XL**

**1/20**







**AY 7323  
WORKER**

Pantalone unisex, multistagione, elastici laterali e passanti in vita, chiusura con zip e bottone in plastica, due tasche anteriori a taglio classico, una tasca laterale LOCK SYSTEM, un porta metro, due tasche posteriori una aperta e una con patta e velcro, inserti ed impunture a contrasto, bande reflex su tasca posteriore, cuciture triple. Bottone chiodo per il colore bianco. Impunture e cuciture in tono, con travette in contrasto giallo fluo, per il colore Blu Navy DTM.

CE I CAT



**i** Twill Sanforizzato Cotone  
260 g/mq

**XS - S - M - L - XL - XXL - 3XL  
4XL - 5XL**

**1/20**



**INSERTI E IMPUNTURE  
A CONTRASTO**



**AY 7320  
WORKER WINTER**

Pantalone unisex, invernale, elastici laterali e passanti in vita, chiusura con zip e bottone in plastica, due tasche anteriori a taglio classico, una tasca laterale LOCK SYSTEM, un porta metro, due tasche posteriori una aperta e una con patta e velcro, inserti ed impunture a contrasto, bande reflex su tasca posteriore, cuciture doppie.

CE I CAT



**i** Satin brushed cotone  
350 g/mq

**XS - S - M - L - XL - XXL - 3XL  
4XL - 5XL**

**1/20**





## AY 7307 WORKER WINTER REFLEX

Pantalone unisex, invernale, con bande riflettenti in cat.1, elastici laterali e passanti in vita, chiusura con zip e bottone in plastica, due tasche anteriori a taglio classico, una tasca laterale LOCK SYSTEM, un porta metro, due tasche posteriori una aperta e una con patta e velcro, inserti ed impunture a contrasto, bande reflex su tasca posteriore, cuciture doppie.

CE I CAT



**i** Satin Brushed Cotone  
350 g/mq

**XS - S - M - L - XL - XXL - 3XL**  
**4XL - 5XL**

**1/20**



## AY 7308 WORKER REFLEX

Pantalone unisex, multistagione, con bande riflettenti in cat.1, elastici laterali e passanti in vita, chiusura con zip e bottone in plastica, due tasche anteriori a taglio classico, una tasca laterale LOCK SYSTEM, un porta metro, due tasche posteriori una aperta e una con patta e velcro, inserti ed impunture a contrasto, bande reflex su tasca posteriore, cuciture triple.

CE I CAT



**i** Satin Brushed Cotone  
260 g/mq

**XS - S - M - L - XL - XXL - 3XL**  
**4XL - 5XL**

**1/20**

# PANTALONI UNISEX

NE



SM



NE



SM



**BANDE  
RIFLETTENTI**

**ELASTICI  
IN VITA**



**AY 7325  
CANYON**

Pantalone unisex, multistagione, elastici laterali e passanti in vita, chiusura con zip e bottone in metallo, due tasche anteriori a taglio classico e una tasca con zip, una tasca laterale LOCK SYSTEM, una doppia tasca lato sinistro porta metro, due tasche posteriori una aperta e una con patta e velcro. Inserti ed impunture a contrasto, bande reflex su tasca posteriore, cucitura tripla interno gamba.



**i** Twill Cotone - 265 g/mq

**XXS - XS - S - M - L - XL - XXL  
3XL - 4XL - 5XL**

**1/20**



**AY 7309  
WORKER TECH**

Pantalone unisex, multistagione con porta ginocchiere, elastici laterali e passanti in vita, chiusura con zip e bottone in plastica, due tasche anteriori a taglio classico, una tasca laterale LOCK SYSTEM, un porta metro e un porta smartphone, due tasche posteriori una aperta e una con patta e velcro, inserti ed impunture a contrasto, bande reflex su tasca posteriore, cuciture triple.



**i** Poliestere 65% + Cotone 35%  
265 g/mq

**XS - S - M - L - XL - XXL - 3XL  
4XL - 5XL**

**1/20**



**PANTALONI  
UNISEX**



**MULTISTAGIONE**





## AY 7326 ENGINE

Pantalone con passanti ed elastico in vita, chiusura con zip e bottone. Cuciture cavallo e interno gamba a doppio ago, due tasche anteriori a taglio classico, porta metro laterale dx, una tasca posteriore con patta e velcro.

CE I CAT

Twill Sanforizzato Cotone  
260 g/mq

XXS - XS - S - M - L - XL - XXL  
3XL - 4XL - 5XL

1/25



RETRO

SM



BL



BL



SM



## AY 7314 POWER

Pantalone con passanti ed elastico in vita, chiusura con zip e bottone. Cuciture cavallo e interno gamba a doppio ago, due tasche anteriori a taglio classico, taschino porta monete, porta metro laterale dx, tasca laterale sx con patta di chiusura LOCK SYSTEM, due tasche posteriori di cui una con patta e velcro.

CE I CAT



Twill Sanforizzato Cotone  
260 g/mq

XXS - XS - S - M - L - XL - XXL  
3XL - 4XL - 5XL

1/25

**PANTALONI  
CON  
CUCITURE A  
DOPPIO AGO  
TASCA  
LATERALE**



**AY 7327  
FOREST SUMMER**

Pantalone uomo, estivo, elastici laterali e passanti in vita, chiusura con zip e bottone in metallo, due tasche anteriori a taglio classico, due tasche laterali con patta e bottoni automatici, una tasca con zip lato sinistro, un porta metro a scomparsa lato destro, due tasche posteriori a filo con asola e bottone.

CE I CAT

Cotone Ripstop - 210 g/mq

XS - S - M - L - XL - XXL - 3XL  
4XL - 5XL

1/20



PANTALONI DA LAVORO



**AY 7332  
FOREST**

Pantalone uomo, multistagione, elastici laterali e passanti in vita, chiusura con zip e bottone in metallo, due tasche anteriori a taglio classico, due tasche laterali con patta e bottoni automatici, una tasca con zip lato sinistro, un porta metro a scomparsa lato destro, due tasche posteriori a filo con asola e bottone. Disponibile in versione da donna: **FOREST LADY**.

CE I CAT

Cotone Twill- 280 g/mq

XS - S - M - L - XL - XXL  
3XL (4XL e 5XL tutte  
disponibili tranne Rosso e  
Verde Militare)

1/20





PAYPER

## AY 7322 WEST

Pantalone multitasche uomo in taglio jeans, 1 tascone laterale LOCK SYSTEM con rinforzo interno, 1 tasca con zip, 1 porta metro, 1 porta smartphone, 1 porta martello, 1 taschino porta penne e cutter, chiusura con zip in metallo e bottone, passanti in vita, trattamento stone washed, effetto consumato e délavé; gamba diritta, cuciture filo grosso a contrasto ed a triplo ago interno gamba. DENIM STRETCH. Peso del tessuto: 10,50 oz. Disponibile nella versione da donna: **WEST LADY**

CE I CAT



**i** Denim 72% + Pol 26% + Elastan 2% - Denim Stretch  
10,5 Oz - 300 g/mq

**1/20** 42-44-46-48-50-52-54-56/58  
60/62 - 64/66 - 68/70-72/74

**1/20**



PAYPER

## AY 7321 SAN FRANCISCO

Pantalone uomo, taglio jeans a cinque tasche, chiusura con zip in metallo e bottone, passanti in vita, 1 porta metro a scomparsa, 1 taschino porta penne e cutter, trattamento stone wash effetto consumato e délavé. Gamba a tubo, cuciture filo grosso a contrasto ed a triplo ago interno gamba. Peso del tessuto: 10,50oz. Disponibile nella versione da donna: **SAN FRANCISCO LADY**

CE I CAT



**i** Denim 72% + Pol 26% + Elastan 2% - Denim Stretch  
10,5 Oz - 300 g/mq

**1/20** 42-44-46-48-50-52-54-56/58  
60/62 - 64/66 - 68/70-72/74

**1/20**



# PANTALONI TAGLIO JEANS



**AY 7300  
CARACAS**

Bermuda uomo, elastici laterali e passanti in vita, chiusura con zip e bottone in plastica, due tasche anteriori a taglio classico, una tasca laterale LOCK SYSTEM, un porta metro, due tasche posteriori una aperta e una con patta e velcro, inserti ed impunture a contrasto, bande reflex su tasca posteriore, cuciture triple.

CE I CAT



**i** Cotone Ripstop - 210g/mq

**XS - S - M - L - XL - XXL - 3XL  
4XL - 5XL**

**1/20**

SM



RETRO



**BANDE  
REFLEX  
POSTERIORI**

**BERMUDA  
UOMO  
MULTI  
TASCHE**

NE



KA



BL



**AY 7302  
RIMINI SUMMER**

Bermuda uomo, elastici laterali e passanti in vita, chiusura con zip e bottone in metallo, due tasche anteriori a taglio classico, due tasche laterali con patta e bottoni automatici, una tasca con zip lato sinistro, un portametro a scomparsa lato destro, due tasche posteriori a filo con asola e bottone. Disponibile nella versione da donna: **RIMINI SUMMER LADY** (nel colore Blu Navy).

CE I CAT

**i** Cotone Ripstop - 210 g/mq

**XS - S - M - L - XL - XXL - 3XL  
4XL - 5XL**

**1/20**

RETRO



NE



**BERMUDA  
UOMO  
MULTI  
TASCHE  
DISPONIBILE  
ANCHE NELLA  
VERSIONE LADY**

KA



BL



MI



SM



RY





## AY 7596 CHARTER WINTER

Pantalone uomo, invernale, in alta visibilità bicolore con bande riflettenti, elastici laterali e passanti in vita, chiusura con zip e bottone in plastica, due tasche anteriori a taglio classico, tasca laterale LOCK SYSTEM, porta metro, due tasche posteriori una aperta e una con patta e velcro. Cuciture a contrasto, cavallo e interno gamba a triplo ago.



**i** Poliestere 80% + Cotone 20% - 295 g/mq

**S** - M - L - XL - XXL - 3XL - 4XL - 5XL

**1/20**



## AY 7597 CHARTER

Pantalone uomo, multistagione, in alta visibilità con bande riflettenti, elastici laterali e passanti in vita, chiusura con zip e bottone in plastica, due tasche anteriori a taglio classico, tasca laterale LOCK SYSTEM, porta metro, due tasche posteriori una aperta e una con patta e velcro. Cuciture a contrasto, cavallo e interno gamba a triplo ago. Disponibile nella versione da donna: **CHARTER LADY**.



**i** Cotone 50% + Poliestere 50% - 250 g/mq

**S** - M - L - XL - XXL - 3XL - 4XL - 5XL

**1/20**



## AY 7591 HI-VI RAINSET

Completo anti pioggia in alta visibilità con bande riflettenti, composto da giacca con zip, cappuccio richiudibile nel colletto, fondo manica dritto, retinatura sulla schiena. Pantalone con elastico in vita e due tasche. Imbusto singolo con zip.



**i** Poliestere Spalmato Poliuretano - 130 g/mq

**M** - L - XL - XXL - 3XL - 4XL - 5XL

**1/10**





## AY 7592 GILET ALTA VISIBILITÀ

Gilet in alta visibilità multitasche con bande rifrangenti, chiusura frontale con zip, due tasche frontali con patta di chiusura una tasca al petto con patta, taschino portapenna, anello per aggancio portabadge. Un portasmartphone e anello di aggancio per portabadge. Interno: imbottito, una tasca interna con velcro, cuciture termonastrate.

 Poliestere

 S - M - L - XL - XXL - 3XL

 1/10

# GILET

## ALTA VISIBILITÀ

### MULTITASCHE CON BANDE RIFRANGENTI



## AY 7225 GILET D'EMERGENZA IN POLIESTERE 150D

Gilet d'emergenza certificato EN20741, in poliestere 150 D

 Polietere 150 D

 M - XL - XXL

 1/10

## GILET CERTIFICATO EN471 CON BANDE RIFRANGENTI





**AY 7582  
LEADER**

Felpa da uomo in alta visibilità con cappuccio e bande riflettenti, zip intera SBS con cursore in metallo autolock, polsini e vita in costina elasticizzata, due tasche frontali con zip coperta, una tasca multifunzione al petto con anello porta badge e patta di chiusura LOCK SYSTEM.



**i** Poliestere - 300 g/mq

**XS - S - M - L - XL - XXL - 3XL  
4XL - 5XL**

**1/20**

# FELPA

**ALTA VISIBILITÀ**

**CON CAPPuccio  
E BANDE  
RIFLETTENTI**

GI



AR





## AY 7583 SHINE

Giacca ergonomica da uomo bicolore in alta visibilità con bande 3M, manica raglan, cappuccio sagomato con due cuciture e coulisse, zip lunga SBS nastrata, polsini regolabili con stringi polso in velcro, due tasche laterali con zip, una tasca al petto, porta badge staccabile e richiudibile una tasca al braccio sinistro.

CE IICAT

3M  
ScotchLite®  
Reflective Material

SBS  
ZIPPER



**i** Soft-Shell 3/1 Twill 75D  
Poliestere - 310 g/mq

**o** S - M - L - XL - XXL - 3XL  
4XL - 5XL

**u** 1/10

# GIACCA ERGONOMICA BICOLORE

## BANDE ALTA VISIBILITÀ 3M

### MANICA RAGLAN



GI



AR



RETRO



## AY 7590 PADDOCK

Giubbino bicolore in alta visibilità con bande riflettenti, zip intera con patta, cappuccio richiudibile nel colletto, vita e polsini elasticizzati, due ampie tasche frontali con patta e velcro, portacellulare e anello di aggancio per porta badge. Interno: imbottito, una tasca con velcro, cuciture termoastrate.

CE IICAT



**i** Poliestere Spalmato  
Poliuretano 300D Oxford  
100% PL/PU 190T Taffetà  
180 g/mq

**S** - M - L - XL - XXL - 3XL  
4XL - 5XL

**1/10**



**GIUBBINO  
BICOLORE**

**ALTA  
VISIBILITÀ**

**CAPPUCCIO  
RICHIUDIBILE**

**INTERNO  
IMBOTTITO**





## AY 7589 YARD

Parka fisso bicolore in alta visibilità con bande riflettenti, zip intera con patta, cappuccio richiudibile nel colletto, polsini in RIB elasticizzato, due tasche frontali con patta, un portasmartphone e anello di aggancio per portabadge. Interno: imbottito, una tasca interna con velcro, cuciture termonastrate.

CE IICAT



**i** Poliestere Spalmato  
Poliuretano 300D Oxford  
100% PL/PU 190T Taffetà  
180 g/mq

S - M - L - XL - XXL - 3XL - 4XL - 5XL

1/10

# PARKA BICOLORE



AR



GI

RETRO





GETLINE



## 1 TOMAIA UPPER

Tomaia resistente, traspirante e impermeabile, in diversi materiali di altissima qualità e abbinamenti cromatici. Dotata di soffiotti in materiale coordinato, presenta travette di rinforzo e una comoda tallonetta antiscalzante ed antiabrasione nel tacco. La calzata è regolare, con sviluppo calibrato per ogni tipo di conformazione del piede.

Sturdy, breathable and waterproof upper; various high-quality materials and colour combinations. Coordinated bellows tongues material, it has reinforcement bartacks and a useful anti-slip and anti-abrasion heel support. The fit is regular, with a calibrated development for each foot type.

## 2 FODERA LINING

La fodera interna è interamente (compresa la punta) in nylon traspirante e resistente all'abrasione.

The lining is fully (including the toe-end) made of breathable nylon and resistant to abrasion.

## 3 OCCHIELLI METALFREE METAL-FREE EYELETS

I comodi occhIELLI metalfree favoriscono un'allacciatura rapida per mantenere il piede saldo, assicurando un sicuro effetto antidistorsione.

The practical metal-free eyelets facilitate a fast lacing in order to keep the foot firm, ensuring an anti-torsion effect.

## 4 PARATACCO HEEL GUARD

Compatto paratacco in pelle bycast con grana pampas idrorepellente, dotato di inserto riflettente.

Compact heel guard in bycast leather with water-repellent pampas grain and reflective panel.

## 5 TOP.ALU.CAP.

L'innovativo puntale in alluminio pressofuso, leggero e ultrasensibile agli impatti fino a 200 Joule. La tecnica dell'iniezione ad alte pressioni e temperature assicura il riempimento omogeneo dello stampo, per una robustezza e sicurezza sempre al top.

The innovative tip in die-cast aluminium, light and anti-static, it is highly resistant to impacts up to 200 Joule. The high pressure and temperature injection technique ensures consistent mould filling, for top-level sturdiness and safety.

## 6 PLANTARE ORTHOLITE® ORTHOLITE® ARCH SUPPORT

Il plantare Ortholite® X40 016 ESD estraibile è 100% traspirabile e mantiene un ambiente sano e asciutto all'interno della scarpa. Completamente lavabile, non compromette nel tempo l'ammortizzazione e la calzata.

The removable Ortholite® X40 016 ESD arch support is 100% breathable and keeps the inside of the shoe healthy and dry. Fully washable, it does not impair the cushioning and fit even over time.

## 7 SOLETTA ANTIPERFORAZIONE PERFORATION-PROOF INSOLE

Solettina in lamina tessile certificata antiperforazione, ad alto coefficiente di rinforzo e resistenza.

Textile insole certified against punctures with high reinforcement and resistance features.

## 8 SOTTOPUNTALE UNDER-TOE

Sottopuntale in policarbonato a ferro di cavallo per aumentare la resistenza allo schiacciamento.

Horseshoe-shaped under-toe in polycarbonate to increase crushing resistance.

## 9 SHANK ANTITORSIONE ANTI-TORSION SHANK

Cambrione o lamina stabilizzatrice antitorsione ultrasensibile in poliammide caricata con fibre sintetiche di rinforzo.

A highly-resistant polyamide shank or plate loaded with synthetic reinforcement fibres.

## 10 INTERSUOLA MID-SOLE

Intersuola con sagoma ortopedica realizzata in durevole poliuretano ultraleggero ESD EPAFLEX. È anti-idrolisi e con elevata resistenza alla compressione.

An orthopaedic-shaped mid-sole made in long-lasting ultra-light polyurethane ESD EPAFLEX. Anti-hydrolysis with high resistance to compression.

## 11 MASTER BALANCE

L'efficace sistema di ammortizzazione Master Balance in PU poliuretano ad alta tenacità e densità bilanciata ammortizza la trasmissione degli urti al tallone, per il mantenimento di una corretta postura in tutto il tempo di utilizzo della scarpa.

The effective Master Balance cushioning system in PU polyether, with high tenacity and balanced density, cushions shocks to the heels, in order to maintain a correct posture for all the time the shoe is worn.

## 12 SUOLA X TRAIL GRIP X TRAIL GRIP SOLE

Suola realizzata con l'esclusiva tecnologia Co.Bo. in TPU (poliuretano termoplastico espanso) ESD resistente sia alle basse che alle medio-alte temperature. Dotata di paratacco e parapunta, garantisce elevata stabilità grazie al grip perfetto antiscivolo adatto a tutte le superfici.

A sole created with the exclusive Co. Bo. technology in TPU (foamed thermoplastic polyurethane) ESD resistant both at low and medium-high temperatures. With both heel guard and tip guard it ensures high stability thanks to the non-slip grip suitable for all surfaces.





## LOW PELLE

Scarpa di sicurezza bassa da uomo, tomaia in pelle idrorepellente e traspirante, fodera interna (per tutta la superficie interna) traspirante e resistente all'abrasione, 6+6 occhielli metalfree, paratacco in grana pampas con inserto riflettente, puntale in alluminio pressofuso, plantare estraibile Ortholite X40 01.6 ESD, soletta in lamina tessile certificata antiperforazione, cambrione antitorsione, sottopuntale a ferro di cavallo, intersuola in poliuretano ultraleggero ESD, ammortizzatore MASTER BALANCE in PU polietere ad alta tenacità e densità bilanciata, suola XTRAIL GRIP in TPU ESD con paratacco e parapunta.

**i** Tutto Fiore Bovino

39 - 40 - 41 - 41,5 - 42 - 42,5  
43 - 43,5 - 44 - 44,5 - 45 - 46  
47 - 48

1

CE IICAT

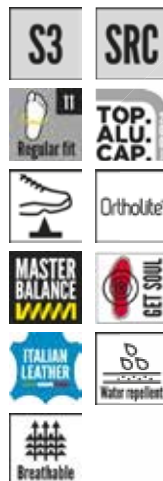

# SCARPE DI SICUREZZA DA UOMO

**IN PELLE S3**



## MID PELLE

Scarpa di sicurezza medium da uomo, tomaia in pelle idrorepellente e traspirante, fodera interna (per tutta la superficie interna) traspirante e resistente all'abrasione, 8+8 occhielli metalfree, paratacco in grana pampas con inserto riflettente, puntale in alluminio pressofuso, plantare estraibile Ortholite X40 01.6 ESD, soletta in lamina tessile certificata antiperforazione, cambrione anti-torsione, sottopuntale a ferro di cavallo, intersuola in poliuretano ultraleggero ESD, ammortizzatore MASTER BALANCE in PU polietere ad alta tenacità e densità bilanciata, suola XTRAIL GRIP in TPU ESD con paratacco e parapunta.

**i** Tutto Fiore Bovino

39 - 40 - 41 - 41,5 - 42 - 42,5  
43 - 43,5 - 44 - 44,5 - 45 - 46  
47 - 48

1

CE IICAT

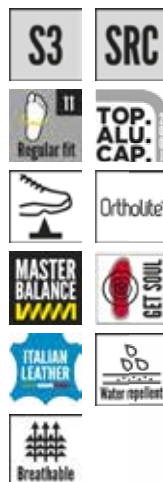





### LOW NABUK

Scarpa di sicurezza bassa da uomo, tomaia in pelle idrorepellente e traspirante, fodera interna (per tutta la superficie interna) traspirante e resistente all'abrasione, 6+6 occhielli metalfree, paratacco in grana pampas con inserto riflettente, puntale in alluminio pressofuso, plantare estraibile Ortholite X40 016 ESD, soletta in lamina tessile certificata antiperforazione, cambrione antitorsione, sottopuntale a ferro di cavallo, intersuola in poliuretano ultraleggero ESD, ammortizzatore MASTER BALANCE in PU polietere ad alta tenacità e densità bilanciata, suola XTRAIL GRIP in TPU ESD con paratacco e parapunta. Disponibile nella versione da donna: **LOW NABUK LD**

CE IICAT



- Fiore Bovino
- 39-40-41-41,5-42-42,5  
43-43,5-44-44,5-45-46  
47-48
- 1



SCARPE  
BASSE DI  
SICUREZZA  
DA UOMO  
**IN NABUK S3**



## MID NABUK

Scarpa di sicurezza medium da uomo, tomaia in pelle idrorepellente e traspirante, fodera interna (per tutta la superficie interna) traspirante e resistente all'abrasione, 8+8 occhielli metalfree, paratacco in grana pampas con inserto riflettente, puntale in alluminio pressofuso, plantare estraibile Ortholite X40 016 ESD, soletta in lamina tessile certificata antiperforazione, cambrione anti-torsione, sottopuntale a ferro di cavallo, intersuola in poliuretano ultraleggero ESD, ammortizzatore MASTER BALANCE in PU polietere ad alta tenacità e densità bilanciata, suola XTRAIL GRIP in TPU ESD con paratacco e parapunta.

CE IICAT



**i** Fiore Bovino

39-40-41-41,5-42-42,5  
43-43,5-44-44,5-45-46  
47-48

**1**



SCARPE  
MEDIUM DI  
SICUREZZA  
DA UOMO

**IN NABUK S3**

PUNTALE  
IN ALLUMINIO



## LOW SCAMOSCIATA

Scarpa di sicurezza bassa da uomo, tomaia in crosta traforata idrorepellente e traspirante, fodera interna (per tutta la superficie interna) traspirante e resistente all'abrasione, 1+1 occhielli metalfree e 6+6 fori passalacci rinforzati, inserti riflettenti nel paratacco e nel lato esterno della punta, puntale in alluminio pressofuso, plantare estraibile Ortholite X40 016 ESD, soletta in lamina tessile certificata antiperforazione, cambrione anti-torsione, sottopuntale a ferro di cavallo, intersuola in poliuretano ultraleggero ESD, ammortizzatore MASTER BALANCE in PU poliuretano ad alta tenacità e densità bilanciata, suola XTRAIL GRIP in TPU ESD con paratacco e parapunta. Disponibile nella versione da donna: **LOW SCAMOSCIATA LD**

CE IICAT

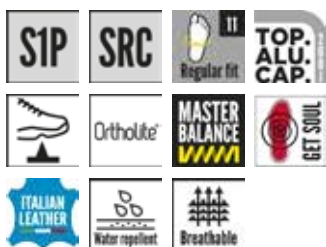

**i** Crosta Bovina

39-40-41-41,5-42-42,5  
43-43,5-44-44,5-45-46  
47-48

**1**



SCARPE  
BASSE DI  
SICUREZZA  
DA UOMO

**IN CROSTA BOVINA**

PUNTALE  
IN ALLUMINIO





## LOW CORDURA

Scarpa di sicurezza bassa da uomo, tomaia in crosta idrorepellente con inserti in tessuto tecnico traspirante, fodera interna (per tutta la superficie interna) traspirante e resistente all'abrasione, 6+6 occhielli metalfree, inserto riflettente nel paratacco, puntale in alluminio pressofuso, plantare estraibile Ortholite X40 016 ESD, soletta in lamina tessile certificata antiperforazione, cambrione antitorsione, sottopuntale a ferro di cavallo, intersuola in poliuretano ultraleggero ESD, ammortizzatore MASTER BALANCE in PU polietere ad alta tenacità e densità bilanciata, suola XTRAIL GRIP in TPU ESD con paratacco e parapunta. Disponibile nella versione da donna: **LOW CORDURA LD**

CE IICAT



**i** Crosta Bovina + Tessuto Tecnico

**o** 39-40-41-41,5-42-42,5  
43-43,5-44-44,5-45-46  
47-48

**o** 1

BL



KA/MI



KA/SA



SCARPE  
BASSE DI  
SICUREZZA  
DA UOMO

**IN CROSTA BOVINA**

OCCHIELLI 6X6

SG/LG



NE



SG/NE



**promo**solution

**IGIENE &  
PROTEZIONE**

## DM015 MASCHERINA FFP3

Mascherina FFP3 NR a cinque strati, finitura termosaldata, con elastici, stringinaso regolabile e nasello interno. Conforme alla normativa EN149: 2001 + A1: 2009 - EN149: 2001 + A1: 2010. Include accessori per il supporto cranico. Non contiene Latex. Composizione: TNT di polipropilene 25 g/mq - Triplo strato di materiale filtrante Meltblown 3x25 g/mq - TNT di polipropilene 25 g/mq.

 20/100



## DM020 MASCHERINA CHIRURGICA

Maschera chirurgica TIPO IIR per uso medico. Triplo strato con finitura termosaldata, supporto elastico e nasello. Efficienza di filtrazione batterica (BFE): >99%. Materiale non tossico e non irritante \*UNE EN 14683:2019+AC.

Dispositivo medico di classe I

 50/500



## AW 6590 GEL DETERGENTE PER MANI

Gel detergente per le mani con stampa, alcol 62%, crema idratante e vitamina E, in PET, capacità 15 ml.

Max misure stampa: Ø 14 mm

 PET

 3,0 x 1,8 x 6,3 cm

 50/250



## ESO100 GEL MANI DA 100 ML

Igienizzante, disinfettante profumato con energica azione antibatterica ad ampio spettro, ad asciugatura rapida che non richiede risciacquo. Battericida, Virucida, rinfrescante, emolliente a completa evaporazione. P.M.C. Reg. Min. Salute N. 18462. Prodotto Certificato EN1500

 100 ml

 1/24



## ESO500 GEL MANI DA 500 ML

Igienizzante, disinfettante profumato con dosatore. Energica azione antibatterica ad ampio spettro, ad asciugatura rapida che non richiede risciacquo. Battericida, Virucida, rinfrescante, emolliente a completa evaporazione. P.M.C. Reg. Min. Salute N. 18462. Prodotto Certificato EN1500

 500 ml

 1/24



## KIT ESOSAN PIANTANA + DOSATORE AUTOMATICO

Piantana per dispenser realizzata in acciaio al carbonio P02.



 35 x 35 x 150 cm

 1



**C500**  
**TUTA DI PROTEZIONE**  
**MONOUSO**



Tuta di protezione monouso in TNT bianco con laminazione esterna bianca. Cappuccio con estremità elasticizzata, elastici stringipolso, stringicaviglia e stringivita. Chiusura a cerniera coperta da pattella adesiva, zip in plastica e tirante in metallo. **Dispositivo di protezione individuale di III categoria di tipo 5-B/6-B.**

-  TNT 55%  
Polypropylene +  
45%  
Polyethylene - 55 g
-  S - M - L - XL  
XXL - 3XL
-  1/10



**SPFH001**  
**TUTA DI PROTEZIONE**  
**MONOUSO**

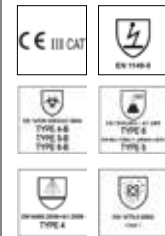

Tuta di protezione monouso in TNT bianco con laminazione esterna bianca. Cappuccio con estremità elasticizzata, elastici stringipolso, stringicaviglia e stringivita. Chiusura a cerniera coperta da pattella adesiva, zip in plastica e tirante in metallo. Cuciture termosaldate con nastro azzurro a contrasto. **Dispositivo di protezione individuale di III categoria di tipo 4-B/5-B/6-B.**

-  TNT 55%  
Polypropylene +  
45%  
Polyethylene - 63 g
-  S - M - L - XL  
XXL - 3XL
-  1/10



**NITRILE**  
**GUANTI MONOUSO**



Guanti nitrile monouso, ambidestri, senza polvere, spessore medio 0,10 mm (rilevato sul palmo). Resistenza, comfort, destrezza, presa, sensibilità, precisione, resistente ai liquidi. Campi d'impiego: contatto con alimenti, manipolazioni leggere e assemblaggio di precisione, ove necessaria la resistenza chimica a detersivi, detergenti e idrocarburi, liquidi e unto in genere.

-  Nitrile
-  S - M - L - XL
-  box da 100 pz.



**PPU01**  
**TUTA DI PROTEZIONE**  
**MONOUSO**



Tuta di protezione, monouso, in TNT, dotata di cappuccio, elastici stringipolso, stringicaviglia e stringivita, chiusura a cerniera con zip nella parte anteriore. Cartone da 50 pezzi confezionati in buste singole.

-  TNT 100%  
Polipropilene - 45 g
-  M - L - XL - XXL - 3XL
-  1/10



**PPU02**  
**CAMICE DI PROTEZIONE**  
**MONOUSO**

Camice di protezione, monouso, in TNT, dotato di stringipolso con elastici e chiusura anteriore con velcro. Cartone da 50 pezzi confezionati in buste singole.

-  TNT 100%  
Polipropilene - 45 g
-  S - L - XXL
-  1/10



**PPU04**  
**CALZARI MONOUSO**



Calzari monouso, in TNT, dotati di elastico stringicaviglia.

-  Tnt 100%  
Polipropilene - 38 g
-  Taglia Unica
-  100/500



## CPS513 VALIGETTA PRONTO SOCCORSO



**Per aziende fino a 2 dipendenti.** Valigetta realizzata in polipropilene antiurto, colore arancio, supporto per attacco a parete, maniglia per trasporto, chiusura con 2 clip rotanti. Contiene: 1 Copia Decreto Min 388 del 15.07.03; 2 Paia guanti sterili; 1 Flacone disinfettante 125 ml IODOPOVIDONE al 10% iodio; 1 soluzione fisiologica sterile 250 ml CE; 1 Busta garza compressa sterile 18x40 cm; 3 Buste garza compressa sterile 10x10 cm; 1 Pinza sterile; 1 Confezione di cotone idrofilo; 1 PLASTOSAN 10 cerotti assortiti; 1 Rocchetto cerotto adesivo m 5x2,5 cm; 1 Benda di garza da m 3,5x10 cm; 1 Paio di forbici 10 cm FOR078; 1 Laccio emostatico; 1 ICE PACK ghiaccio istantaneo monouso; 1 Sacchetto per rifiuti sanitari 250x350 mm.

-  **Plastica - 1,40 kg**
-  **25x19x9 cm**
-  **1/12**



## CPS517 VALIGETTA PRONTO SOCCORSO



**Per aziende con tre o più dipendenti.** Valigetta di colore arancio, supporto per attacco parete, maniglia per trasporto, guarnizione in neoprene e chiusura con due clip rotanti. Contiene: 1 Copia Decreto Min 388 del 15.07.03 - 5 Paia guanti sterili - 1 Mascherina con visiera paraschizzi - 3 Flaconi soluzione fisiologica sterile 500 ml CE - 2 Flaconi disinfettante 500 ml IODOPOVIDONE al 10% iodio PMC - 10 Buste garza compressa sterile 10x10 cm - 2 Buste garza compressa sterile 18x40 cm - 2 Teli sterili 40x60 cm DIN 13152-BR - 2 Pinze sterili - 1 Confezione di cotone idrofilo - 1 Astuccio benda tubolare elastica - 2 PLASTOSAN 10 cerotti assortiti - 2 Rocchetti cerotto adesivo m 5 x 2,5 cm - 1 Paio di forbici tagliabendaggi cm 14,5 DIN 58279 - 3 Lacci emostatici - 2 ICE PACK ghiaccio istantaneo - 2 Sacchetti per rifiuti sanitari minigrip - 1 Termometro clinico digitale CE - 1 Sfigmomanometro PERSONAL con fonendoscopio

-  **Plastica - 6,20 kg**
-  **39,5 x 13,5 x 27 cm**
-  **1/6**



## PDM090 PACCO REINTEGRO CPS513



Pacco medicazione per cassette pronto soccorso **per aziende fino a 2 dipendenti** con contenuto base allegato 2 a norma del DM 388 del 15.7.2003 e D.L. 81 del 09/04/08 art.45.

-  **Carta - 1,05 kg**
-  **1/12**



## PDM091 PACCO REINTEGRO CPS517

Pacco medicazione per cassette pronto soccorso **per aziende con 3 o più dipendenti** con contenuto base a norma del DM 388 allegato 1 e D.L. 81 del 09/04/08 art.45 versione SENZA SFIGMOMANOMETRO. Per rispettare il DM 388 è necessario integrare il contenuto con lo sfigmomanometro che in questo pacco non è compreso.

-  **Carta - 3,90 kg**
-  **1/12**





**promo**solution

**CAPPELLI**

# CAPPELLI

## AY 7370 GOLF ADULTO

Cappello 5 pannelli, fascia tergisudore, occhielli ricamati, frontale rinforzato, visiera rigida sagomata, regolatore misura in velcro, colori reattivi.

**Max. misure stampa:** 90x50 mm

 100% cotone drill 108/58

 Taglia Unica

 50/200

# CAPPELLO GOLF 5 PANNELLI



AR

NE



RETRO



BI



VE



BL



BO



GR



VF



RY



RO



EC



VM



AZ



GI



**AY 7369  
GOLF BAMBINO**

Cappello 5 pannelli, fascia tergisudore, occhietti ricamati, frontale rinforzato, visiera rigida sagomata, regolatore misura in velcro, colori reattivi.

**Max. misure stampa:** 90x50 mm

 100% cotone drill 108/58

 Taglia Unica

 50/200



# CAPPELLO BAMBINO 5 PANNELLI

BI

VE



VM



RO



AR



GI



BL



RY



NE



# CAPPELLI

## AY 7397 SANDWICH

Cappello 5 pannelli, fascia tergisudore, occhielli ricamati, frontale rinforzato, visiera rigida sagomata e bordata, regolatore misura in velcro, colori reattivi.

Max. misure stampa: 90x50 mm

 Cotone Twill 100% - 54 g

 Taglia Unica

 50/200



RY



*Visiera Bordata*



BL



GI



AR



RO



EC



NE



GR



BI



VF



VE



**AY 7377****ITALY**

Cappello 5 pannelli, con bandierina Italia ricamata lateralmente, fascia tergisudore, occhielli ricamati, frontale rinforzato, visiera rigida sagomata e bordata, regolatore misura in velcro, colori reattivi.

**Max. misure stampa:** 90x50 mm

**i** 100% cotone drill 108/58

**✂** Taglia Unica

**👁** 50/200



BI  
**BANDIERA  
ITALIANA  
RICAMATA**

BL



RY



BI



NE



VE



RO



# CAPPELLI

## AY 7375 ESTORIL

Cappello a 5 pannelli, scocca bianca con piping, occhielli e bottone colorati, chiusura posteriore con velcro.

Max. misure stampa: 90x50 mm

 Cotone + Poliestere 50g

 Taglia Unica



 50/200

# CAPPELLO 5 PANNELLI

## ADATTO ALLA SUBLIMAZIONE



BI/VM

BI/BL



RETRO

BI/RY



BI/RO



BI/AR



BI/VE



**AY 7394  
SANDWICH  
WINTER**

Cappello 5 pannelli in cotone pesante segmento frontale rinforzato, 4 fori rifiniti con cucitura, chiusura a strappo ampiamente regolabile sulla nuca, 100% cotone (heavy-brushed).

**Max. misure stampa:** 90x50 mm

 Cotone pesante - 80g

 Taglia Unica

 50/200



CAPPELLO  
5 PANNELLI  
IN COTONE  
PESANTE





# CAPPELLI

## AY 7380

### MESH

Cappello 5 pannelli, segmenti posteriori in rete, chiusura regolabile in ABS, Cotone twill e ABS.

Max. misure stampa: 90x50 mm

-  Cotone / Garza / PE
-  Plastica - 55 g
-  Taglia Unica
-  50/200



## CAPPELLO 5 PANNELLI



SEGMENTI POSTERIORI IN RETE





## AY 7379

### HUNTING

Cappello mimetico, visiera rigida sagomata, regolatore misura in velcro.

Max. misure stampa: 90x30 mm

-  Cotone - 50 g
-  Taglia Unica
-  50/200

## CAPPELLO MIMETICO





**AY 7400  
MIRAMARE**

Cappello miramare 100% cotone.

Max. misure stampa: 100x50 mm

 100% Cotone 160 gsm - 30 g Ø 25 cm 50/300

EC



# CAPPELLI

## AY 7398 FOULARD

Foulard uomo/donna di forma triangolare fatto cotone, adatto alla sublimazione.

**i** 100% Poliestere, tatto Cotone, 65 g/mq

**100 x H. 50 cm**



**100/200**

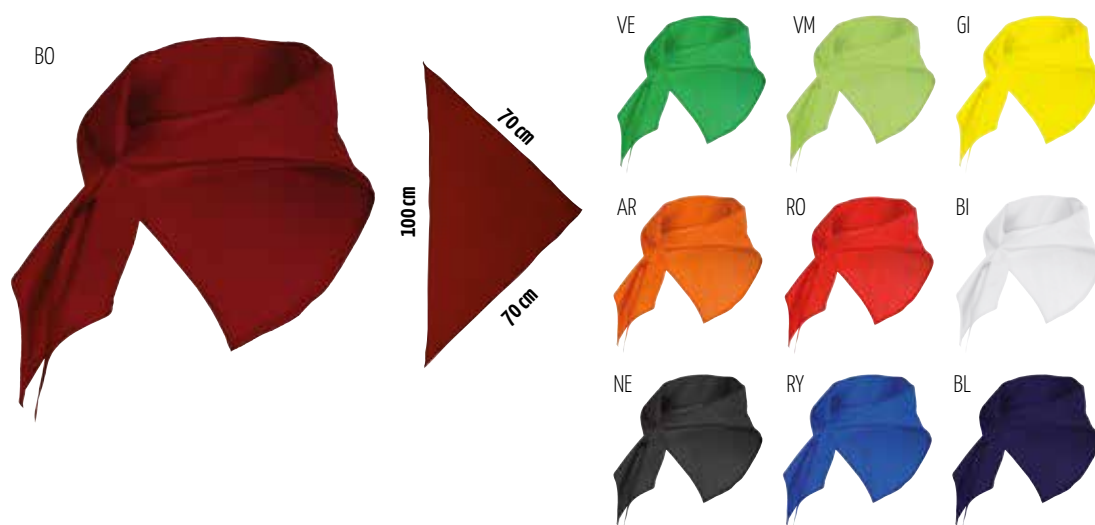

## AY 7401 BANDANA

Bandana in cotone e poliestere.  
Max. misure stampa: 90x25 mm

**i** Cotone + Poliestere

**Taglia Unica**

**100/200**



**AY 7403**  
**FASCIA**  
**SCALDACOLLO**

Scaldacollo in pile con regolatore elastico. Trasformabile in cappello grazie alla coulisse.

Max. misure stampa: 90x40 mm

**i** 100% Poliestere, Pile  
210 g/mq

**✂** Taglia Unica

**👒** 50/200

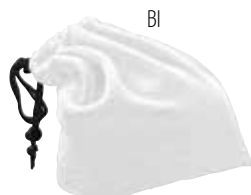

**FASCIA**  
**SCALDACOLLO**



**AY 7403-E**  
**FASCIA**  
**SCALDACOLLO**

Scaldacollo in pile con regolatore elastico. Trasformabile in cappello grazie alla coulisse. Con etichetta.

Max. misure stampa: 45x10 mm

**i** 100% Poliestere, Pile  
210 g/mq

**✂** Taglia Unica

**👒** 50/200

# CAPPELLI

## AY 7427 ZUCCOTTO IN PILE

In poliestere pile 200 gr.

Max. misure stampa: 90x40 mm

 Poliestere Pile - 200 gr/mq

 Taglia Unica

 50/200

RO



GR

BL

NE



## AY 7427-E ZUCCOTTO IN PILE

In poliestere con etichetta, pile 200 gr.

Max. misure stampa: 55x18 mm

 Poliestere Pile - 200 gr/mq

 Taglia Unica

 50/200

RO



GR

BL

NE



## AY 7425 ZUCCOTTO IN ACRILICO

In poliestere/acrilico 75 gr.

Max. misure stampa: 90x40 mm

 100% Acrilico - 75 gr/mq

 Taglia Unica

 20/200

RY



RO

NE

GR

BL



## AY 7425-E ZUCCOTTO IN ACRILICO

Con etichetta. In poliestere/acrilico 75 g.

Max. misure stampa: 40x20 mm

 100% Acrilico - 75 gr/mq

 Taglia Unica

 20/200

RY



RO

NE

GR

BL



## TROVA LA SOLUZIONE GIUSTA PER TE!

Il nuovo catalogo PROMOSOLUTION è pronto a sorprenderti con una vastità di prodotti, forme e colori. I nostri gadget sono scelti con cura e meticolosità per soddisfare tutte le esigenze di personalizzazione dei vostri clienti!

## GADGET SEMPRE PIÙ INNOVATIVI E SOSTENIBILI

Negli ultimi anni, l'attenzione e la sensibilità verso le tematiche ambientali è sempre più alta; per questo motivo all'interno del catalogo PROMOSOLUTION gli articoli eco friendly, realizzati con materiali naturali, rinnovabili, riciclati e riutilizzabili sono in costante aumento.

## SCEGLIERE QUESTI PRODOTTI SIGNIFICA AMARE E RISPETTARE IL NOSTRO PIANETA.



L'aspetto ECOLOGICO dei nostri gadget si evidenzia in 3 aspetti fondamentali: all'interno del catalogo troverai **prodotti durevoli** per la **qualità delle materie prime**, prodotti realizzati con **materiali rinnovabili** e prodotti realizzati con **materiali riciclabili**.



### BAMBOO

Basso impatto ambientale,  
materiale stabile e resistente



### COTONE

Fibra naturale, rinnovabile  
e biodegradabile



### SUGHERO

Fibra naturale, rinnovabile  
e biodegradabile



### PLASTICA RICICLATA

Risparmio di circa il 60% di CO<sub>2</sub>



### PAGLIA DI GRANO

Risorsa efficiente e rinnovabile



### CARTA RICICLATA

Risparmio di acqua e di energia





## LA QUALITÀ MADE IN ITALY

UN GRANDE ASSORTIMENTO  
DI PRODOTTI MADE IN ITALY  
PER REGALARTI QUALITÀ E DESIGN



### EXCLUSIVE BUSINESS

Abbiamo selezionato nella nostra collezione marchi come **Parker, Hugo Boss, The Bridge, Laville, Jaguar, Cerruti, Cacharel, Christian Lacroix** per offrire ai vostri clienti il valore aggiunto di un regalo di qualità!



**promosolution**  
ADVERTISING & GADGET

### PRODOTTI PROMOZIONALI SICURI E CERTIFICATI



**promo**solution

**GRANDI  
FIRME**

## THE BRIDGE

AB 0211

CARTELLA

PORTA

DOCUMENTI/PC

In pelle bovina conciata al vegetale tinta a mano, doppio manico, doppio scomparto con chiusura zip a doppio cursore, tasca interna portacomputer imbottita, tasca esterna con chiusura a zip. Dotata di tracolla rimovibile. Made in Italy.

 Pelle

 41 x 32 x 13 cm

 1



## CARTELLA PORTA DOCUMENTI PC



## THE BRIDGE

AB 0213

ZAINO

In pelle bovina conciata al vegetale tinta a mano, chiusura a zip con doppio cursore, tasca portacomputer imbottita, tasca esterna con chiusura a zip a doppio cursore. Made in Italy.

 Pelle

 39 x 31 x 11 cm

 1



## ZAINO CON TASCA IMBOTTITA PORTA COMPUTER





**THE BRIDGE****AB 0205****ZAINO**

In pelle bovina conciata al vegetale tinta a mano, chiusura a zip con doppio cursore, tasca portacomputer imbottita, tre tasche esterne di cui una con chiusura a zip e due con chiusura a calamita. Made in Italy.

 Pelle

 39 x 28 x 10 cm

 1



**ZAINO** IN PELLE  
TASCA IMBOTTITA  
PORTACOMPUTER  
CHIUSURE CON ZIP  
E MAGNETICHE

**THE BRIDGE****AB 0229****CARTELLA****PORTA  
DOCUMENTI/PC**

Cartella professionale in pelle bovina conciata al vegetale, tinta a mano, due scomparti interni imbottiti porta computer e porta tablet, doppia chiusura a scatto. Dotata di tracolla rimovibile. Made in Italy.

 Pelle

 41 x 31 x 14 cm

 1



**CARTELLA**  
PORTA  
DOCUMENTI  
PC



## THE BRIDGE

**AB 0329**

**BORSA DA VIAGGIO**

In pelle bovina conciata al vegetale tinta a mano, doppio manico, chiusura con zip a doppio cursore, tracolla rimovibile. Made in Italy.

 Pelle

 50 x 27 x 22 cm

 1



## BORSA DA VIAGGIO DOPPIO MANICO



## THE BRIDGE

**AB 0328**

**TROLLEY DA VIAGGIO**

In pelle bovina conciata al vegetale tinta a mano, chiusura con zip a doppio cursore, tasca esterna con chiusura a zip, manico rivestito in pelle, tasca interna con chiusura a zip. Made in Italy.

 Pelle

 53 x 40 x 20 cm

 1



## TROLLEY DA VIAGGIO TASCHE CON ZIP



**THE BRIDGE****AB 0283****BEAUTY CASE**

In pelle bovina conciata al vegetale tinta a mano, chiusura con zip. Made in Italy.

 Pelle

 16,5 x 9,5 x 4 cm

 1

**BEAUTY CASE CHIUSURA CON ZIP****THE BRIDGE****AB 0285****BEAUTY CASE**

Beauty case in pelle bovina conciata al vegetale tinta a mano, chiusura con zip. Made in Italy.

 Pelle

 22,5 x 10 x 11,5 cm

 1

**THE BRIDGE****AB 0284****BEAUTY CASE**

Beauty case in pelle bovina conciata al vegetale tinta a mano, chiusura con zip. Made in Italy.

 Pelle

 26 x 18 x 15 cm

 1



## THE BRIDGE

### AB 0245 PORTAFOGLI UOMO

In pelle bovina conciata al vegetale tinta a mano, chiusura a zip, varie tasche esterne e scomparti porta carte di credito su entrambi i lati. Made in Italy.

 Pelle

 12,5 x 9,5 x 1 cm

 1



## PORTAFOGLI CON ZIP

## THE BRIDGE

### AB 0242 PORTAFOGLI UOMO

In pelle bovina conciata al vegetale tinta a mano, varie tasche interne porta carte di credito, tasca porta monete. Made in Italy.

 Pelle

 25,5 x 9,3 x 1 cm

 1



## PORTAFOGLI CON TASCHE PORTA MONETE E CARD



## THE BRIDGE

### AB 0274 CINTURA UOMO

Cintura in vera pelle bovina con fibbia in metallo lucido. Made in Italy.

 Pelle

 110 x 4 cm

 1



## CINTURA CON FIBBIA IN METALLO LUCIDO



**THE BRIDGE****AB 0270  
CARTELLA  
PORTADOCUMENTI**

In pelle bovina conciata al vegetale tinta a mano, tasche interne e scomparti porta carte di credito, chiusura a zip. Made in Italy.

 Pelle

 24 x 32 x 1 cm

 1

**CARTELLA  
PORTA  
DOCUMENTI****THE BRIDGE****AB 0265  
MOUSE  
PAD**

In pelle bovina conciata al vegetale tinta a mano. Made in Italy.

 Pelle

 20 x 24 cm

 1

**MOUSE  
PAD**

## THE BRIDGE

### AB 0305 PORTACHIAVI

In pelle bovina conciata al vegetale tinta a mano con particolari in acciaio. Made in Italy.

-  Pelle
-  10 x 2 cm
-  1



## THE BRIDGE

### AB 0306 PORTACHIAVI

In pelle bovina conciata al vegetale tinta a mano con particolari in acciaio. Made in Italy.



-  Pelle
-  10 x 4 cm
-  1



## THE BRIDGE

### AB 0298 PORTACHIAVI

In pelle bovina conciata al vegetale tinta a mano con particolari in acciaio. Made in Italy.



-  Pelle
-  15 x 3 cm
-  1



## THE BRIDGE

### AB 0197 TRACOLLA PORTADOCUMENTI

Tracolla in pelle bovina conciata al vegetale tinta a mano, chiusura a zip con doppio cursore, due tasche esterne con chiusura a calamita. Made in Italy.

-  Pelle
-  32 x 25 x 8 cm
-  1



## TRACOLLA PORTA DOCUMENTI



**THE BRIDGE****AB 0244****PORTAFOGLI UOMO**

In pelle bovina conciata al vegetale tinta a mano, 2 tasche porta banconote e 8 tasche porta carte di credito. Made in Italy.

 Pelle

 11 x 9 x 1 cm

 1

**PORTAFOGLI  
IN PELLE TINTA A MANO**
**THE BRIDGE****AB 0246****PORTA CARTE  
DI CREDITO**

In pelle bovina conciata al vegetale tinta a mano, 2 tasche grandi e 6 tasche portacarte di credito. Made in Italy.

 Pelle

 12 x 9 cm

 1

**PORTAFOGLI  
CON TASCHE  
PORTA CARTE  
DI CREDITO**
**THE BRIDGE****AB 0275****CINTURA UOMO**

Cintura in vera pelle bovina con fibbia in metallo lucido. Made in Italy.

 Pelle

 110 x 4 cm

 1

**CINTURA  
CON FIBBIA  
IN METALLO  
LUCIDO**



## THE BRIDGE

**AB 0235**

**PORTAFOGLI UOMO**

In pelle bovina conciata al vegetale tinta a mano, varie tasche interne porta carte di credito, tasca porta monete. Made in Italy.

 Pelle

 11 x 9,5 x 1 cm

 1



**PORTAFOGLI  
CON TASCHE PORTA  
MONETE E PORTA CARDS**

## THE BRIDGE

**AB 0236**

**PORTAFOGLI UOMO**

In pelle bovina conciata al vegetale tinta a mano, varie tasche interne porta carte di credito. Made in Italy.

 Pelle

 11 x 9 x 1 cm

 1



## THE BRIDGE

**AB 0240**

**PORTA CARTE DI  
CREDITO**

In pelle bovina conciata al vegetale tinta a mano, varie tasche interne. Made in Italy.

 Pelle

 9 x 10 x 1 cm



 1







**THE BRIDGE****AB 0206  
BORSA DONNA**

Borsa in canvas con finiture in pelle bovina conciata al vegetale tinta a mano, tracollina regolabile. Made in Italy.

-  Canvas e Pelle
-  25 x 18 x 8 cm
-  1

**BORSA DA DONNA  
CON TRACOLLA  
REGOLABILE****THE BRIDGE****AB 0228  
PORTAFOGLI DONNA**

In pelle bovina conciata al vegetale tinta a mano, 2 scomparti interni più tasca con zip, pattina porta tessere. Made in Italy.

-  Canvas e Pelle
-  17 x 10,5 x 2,3 cm
-  1

**PORTAFOGLI  
DA DONNA**

## THE BRIDGE

**AB 0207**

### BORSA DONNA

Borsa con tracolla in pelle bovina conciata al vegetale tinta a mano, pattina frontale e chiusura con bottone automatico, tasca interna con zip. Made in Italy.

 Pelle

 24 x 18,5 x 10 cm

 1



## BORSA CON TRACOLLA



## THE BRIDGE

**AB 0222**

### ZAINETTO DONNA

Zaino in pelle bovina conciata al vegetale tinta a mano, pattina frontale e chiusura con passante, tasca interna con zip, ampia tasca esterna. Made in Italy.

 Pelle

 26 x 31 x 16 cm

 1



## ZAINO DONNA CHIUSURA PATTINA E PASSANTE



**THE BRIDGE****AB 0208  
BORSA DONNA  
PORTADOCUMENTI**

Borsa donna in pelle bovina conciata al vegetale, doppio manico, chiusura con zip, dotata di tracolla. Made in Italy.

 Pelle

 50 x 34 x 4 cm

 1

**BORSA  
DA DONNA  
PORTA  
DOCUMENTI**
**THE BRIDGE****AB 0210  
CARTELLA  
PORTADOCUMENTI**

Professionale in pelle bovina conciata al vegetale tinta a mano, doppio manico, scomparto principale con cerniera doppio cursore, tasca interna porta computer, portapenna, portaocchiali e porta cellulare, tracolla rimovibile, Made in Italy.

 Pelle

 35 x 27 x 7 cm

 1

**CARTELLA  
PORTA  
DOCUMENTI  
PROFESSIONALE**

## THE BRIDGE

**AB 0232**

**BORSA DONNA**

Borsa in pelle bovina conciata al vegetale tinta a mano, doppio manico, tasca interna portaoggetti con zip. Made in Italy.



Pelle

32 x 27 x 10 cm

1

**BORSA  
DONNA  
DOPPIO  
MANICO**



## THE BRIDGE

**AB 0209**

**ZAINO**

In pelle bovina conciata al vegetale tinta a mano, chiusura a zip con doppio cursore, tasca esterna portaoggetti. Made in Italy.



Pelle

26 x 32 x 12 cm

1



**THE BRIDGE****AB 0225****PORTAFOGLI DONNA**

In pelle bovina conciata al vegetale tinta a mano, 2 scomparti interni, chiusura con zip. Made in Italy.

 Pelle

 18 x 11 x 2 cm

 1



**PORTAFOGLI  
DONNA  
CHIUSURA  
CON ZIP**

**THE BRIDGE****AB 0226****PORTAFOGLI DONNA**

In pelle bovina conciata al vegetale tinta a mano, 2 scomparti interni più tasca con zip, pattina porta tessere. Made in Italy.

 Pelle

 17 x 10,5 x 2,5 cm

 1



**PORTAFOGLI  
DONNA  
CON PATTINA  
PORTA  
TESSERE**

**THE BRIDGE****AB 0220****NECESSAIRE**

in pelle bovina conciata al vegetale tinta a mano, chiusura con zip, manico. Made in Italy.

 Pelle

 21 x 12 x 5 cm

 1



**NECESSAIRE  
CON MANICO  
E CHIUSURA  
ZIP**

## THE BRIDGE

**AB 0217**

### BORSA DONNA

Borsa con tracolla in pelle bovina conciata al vegetale tinta a mano, pattina frontale e chiusura con bottone automatico, tasca interna con zip. Made in Italy.

 Pelle

 20 x 15 x 7 cm

 1



## BORSA DONNA CON TRACOLLA



## THE BRIDGE

**AB 0230**

### BORSA DONNA

Borsa in pelle bovina conciata al vegetale tinta a mano, doppio manico, tasca interna portaoggetti con zip. Made in Italy.

 Pelle

 31,5 x 30 x 13 cm

 1



## BORSA DONNA DOPPIO MANICO CHIUSURA CON ZIP



**THE BRIDGE****AB 0231****BORSA DONNA**

Borsa in pelle bovina conciata al vegetale tinta a mano, chiusura con linguetta, tasca interna con zip, dotata di tracolla rimovibile. Made in Italy.

 Pelle

 29 x 19 x 13 cm

 1

**BORSA  
DONNA CON  
TRACOLLA  
CHIUSURA  
CON  
LINGUETTA**
**THE BRIDGE****AB 0317****BORSA DONNA**

Borsa in pelle bovina conciata al vegetale tinta a mano, doppio manico, chiusura a coulisse, tasca interna con zip, dotata di tracolla rimovibile. Made in Italy.

 Pelle

 25 x 29 x 12 cm

 1



**BORSA  
DONNA  
DOPPIO  
MANICO  
CHIUSURA  
A COULISSE**

## THE BRIDGE

### AB 0185 ZAINO

Zaino in canvas con finiture in pelle bovina conciata al vegetale tinta a mano, due scomparti con chiusura zip a doppio cursore, tasca interna portacomputer imbottita, tasca esterna con chiusura a calamita, portabottiglia laterale rimovibile. Made in Italy.

 Canvas e Pelle

 43 x 30 x 12 cm

 1



## THE BRIDGE

### AB 0180 ZAINO

Zaino in canvas con finiture in pelle bovina conciata al vegetale tinta a mano, chiusura zip a doppio cursore, tasca interna portacomputer imbottita, tasca esterna con chiusura a calamita. Made in Italy.

 Canvas e Pelle

 43 x 30 x 11 cm

 1





**THE BRIDGE****AB 0178  
CARTELLA  
PORTADOCUMENTI**

In canvas e pelle bovina conciata al vegetale tinta a mano, tasche interne e scomparti porta carte di credito, chiusura a zip. Made in Italy.

 Canvas e Pelle

 32,2 x 25 x 2,5 cm

 1

**CARTELLA  
PORTA  
DOCUMENTI  
CHIUSURA  
CON ZIP****THE BRIDGE****AB 0177  
BEAUTY**

Beauty case in canvas con finiture in pelle, chiusura con zip. Made in Italy.

 Canvas e Pelle

 15 x 23 x 10 cm

 1

**BEAUTY  
CASE  
IN CANVAS  
CHIUSURA  
CON ZIP**

# HUGO BOSS

## AB 0380 BORRACCIA

Della collezione Gear Matrix Hugo Boss, realizzata in acciaio AISI 304 doppio spessore per ottenere una performance da 24h freddo e 12h caldo. Tappo a vite in silicone ABS resistente alle alte temperature. **Capacità 500 ml.** Confezionato in scatola regalo Hugo Boss.

**i** Acciaio AISI 304

**Ø** 6,7 x H 26,5 cm

**1**

# BORRACCIA IN ACCIAIO

DELLA COLLEZIONE GEAR MATRIX





DOPPIO SPESSORE  
TAPPO A VITE



**HUGO BOSS****AB 0385  
AURICOLARI**

Auricolari di ultima generazione della collezione Gear Matrix di Hugo Boss, 6 ore di carica con Case da ricarica 28 ore. Chipset di ultima generazione "ultra clear sound" JL2697. Funzionalità haptic touch per rispondere/interrompere telefonate direttamente dall'auricolare e funzione di start/stop della musica. Ricarica USB-C o ricarica wireless con Qi technology. Funzione di noise cancellation. Doppio microfono per ogni auricolare. Confezionato in scatola regalo Hugo Boss.



-  **ABS/Rubber**
-  **6,5 x 2,9 x H 4,3 cm**
-  **1**

**AURICOLARI  
DI ULTIMA  
GENERAZIONE**

DALLA  
COLLEZIONE  
GEAR MATRIX

**HUGO BOSS****AB 0386  
SPEAKER**

Speaker ultima generazione della collezione Gear Matrix di Hugo Boss. Con la sua tecnologia di connettività wireless, accoppia qualsiasi dispositivo mobile e ascolta la tua musica o la tua radio preferita, rispondi a una chiamata ed effettua chiamate in conferenza con facilità senza dover usare il tuo cellulare. Confezionato in scatola regalo Hugo Boss.

-  **Rubber**
-  **Ø 5,6 x H 6,6 cm**
-  **1**

**SPEAKER WIRELESS  
ACCOPPIA QUALSIASI  
DISPOSITIVO MOBILE**

## HUGO BOSS

### AB 0387 CARICABATTERIE WIRELESS

Compatibile con tutti i dispositivi Q1. Finitura in alluminio con eleganti angoli arrotondati e sottile logo Hugo Boss. Il pad di ricarica è realizzato in tessuto. Fornito in una lussuosa confezione regalo Hugo Boss che include un cavo Type-C da 1M e un manuale utente.

 Alluminio

 8,4 x 9,5 cm

 1



## HUGO BOSS

### AB 0388 SPEAKER WIRELESS

Speaker Hugo Boss GEAR 10W composto da 2 x 5W ad altissima definizione che rende un'esperienza sonora stereo nitida e potente con bassi profondi. L'altoparlante ha una batteria interna in grado di suonare fino a 15 ore senza bisogno di una carica e utilizza l'ultima tecnologia Bluetooth 5.0. Guscio esterno realizzato in alluminio di alta qualità con finitura touch dotato di 3 pulsanti intuitivi. Dispone anche di un ingresso AUX per collegare altri dispositivi utilizzando un cavo jack. Fornito in elegante astuccio.

 Alluminio

 Ø 13 x 6 cm

 1



**HUGO BOSS****AC 1390  
TROLLEY CABINA**

Trolley Hugo Boss realizzato in ABS con pattern in stile diamante per un look di stile ed eleganza. Lining interno in alta qualità, doppia tasca interna a rete, chiusura a zip. Chiusura TSA integrata. Confezionato in sacca nylon nera Hugo Boss.

 ABS - 3,8 kg

 55 x 36 x 19 cm - Vol: 50 lt

 1



**TROLLEY**  
STILE  
DIAMANTE  
CHIUSURA TSA  
INTEGRATA



## CERRUTI 1881

### AB 0680 CARTELLA PORTABLOCCO A4

Cartella in morbida similpelle nera con logo Cerruti 1881 in metallo cromato. Dotata di blocco note interno, chiusura con zip. Confezionata in box regalo.

 Similpelle

 32,5 x 24,5 x 2,5 cm

 1



**CARTELLA** PORTA  
BLOCCO A4

## CERRUTI 1881

### AB 0678 PORTACARD

Chiusura con zip, realizzato in pelle nera liscia accuratamente selezionata.

 Pelle

 11,3 x 9 cm

 1



**PORTACARD** CON CHIUSURA ZIP

## CERRUTI 1881

### AB 0679 PORTACARD

Chiusura con zip, realizzato in pelle nera liscia accuratamente selezionata.

 Pelle

 13 x 7 cm

 1



**CERRUTI 1881****AB 0645  
BEAUTY CASE**

Bauty "Irving" di Cerruti 1881 lussuoso, compatto e semplice. Realizzati in morbida similpelle, strutturato e impreziosito dalla nuova targhetta CERRUTI 1881, la sua forma non è solo originale, ma è anche molto pratica.

 Similpelle

 23 x 11 x 11 cm

 1

**BEAUTY  
IN MORBIDA  
SIMILPELLE****CERRUTI 1881****AB 0650  
TRACOLLA**

Tracolla Hamilton di Cerruti 1881 realizzata in similpelle nera, chiusura con zip a doppio cursore, tasca esterna con zip, cinturino regolabile e amovibile.

 Similpelle

 26 x 21 x 5 cm

 1

**CERRUTI 1881****AB 0676  
PORTAFOGLI  
UOMO**

"Irving" CERRUTI 1881 realizzato in pelle accuratamente scelta, con una leggera grana e ornato da una piastra in acciaio inossidabile, vari scomparti porta carte di credito.

 Pelle

 11 x 9,5 x 1,4 cm

 1



NE



BL

## CERRUTI 1881

**AB 0685**

### ZAINO

Zaino poliestere CERRUTI 1881 con chiusura a doppia zip, scomparto con interno imbottito per tablet e computer portatile 15", connettore USB, due spallacci imbottiti e regolabili.

 Poliestere

 49 x 33 x 14 cm

 1



**ZAINO** IN POLIESTERE CON TASCA PER COMPUTER E TABLET IMBOTTITA  
CHIUSURA DOPPIA ZIP





**CERRUTI 1881****AC 1483  
TROLLEY CABINA**

In poliestere, con struttura super light, 2 ruote, chiusura con zip a doppio cursore, dotato di porta usb esterna con cavo interno, spallacci imbottiti a scomparsa, tascone esterno richiudibile con zip.

 Poliestere

 50 x 35 x 27 cm

 1

**TROLLEY**  
STRUTTURA  
SUPER LIGHT

CHIUSURA ZIP  
E PORTA USB





## LAVILLE PARIS

**AB 0480**

### PALLINA DI NATALE

Per un Natale scintillante e luminoso!  
Una collezione di palline di Natale con decorazioni realizzate in Poli-Crystal trasparente che si illuminano rendendo magica l'atmosfera della vostra casa. Disponibile in 3 varianti assortite. Confezionate in scatola regalo

-  Poli-Crystal
-  Ø 8,5 cm
-  1





## LAVILLE PARIS

**AB 0458**

### PROFUMATORE 50 ML

Creato con l'utilizzo di fragranze francesi, contenuto in flacone di vetro con bastoncini in legno. Confezione in box regalo LAVILLE.

-  Vetro e legno
-  8 x 4,5 cm
-  1



**LAVILLE PARIS****AB 0460  
SCIARPA**

Lasciatevi conquistare dal calore avvolgente della sciarpa imbottita firmata Laville. La nuance si abbina a tutta la palette di stagione e aggiunge un tocco moderno alle vostre mise. Confezionata in sacchetto con chiusura a zip.

 Poliestere

 85 x 11 cm

 1

**LAVILLE PARIS****AB 0473  
PORTACARD**

In ecopelle nera. Confezionato in scatola di cartoncino Laville Paris.

 Ecopelle

 10 x 7,5 cm

 1

**LAVILLE PARIS****AB 0483  
PORTACHIAVI  
VESPA**

Portachiavi in metallo nelle varianti cromo, oro e oro rosa. Confezionato in Gift box.

 Metallo

 5 x 5 cm

 1



## LAVILLE PARIS

AB 0469

### SET VIAGGIO 3 PZ

Un pratico tris viaggio, realizzato in polycotton two tone di colore grigio. Arricchito dalla stampa "Vintage" di LAVILLE PARIS. Il set è composto da:

- BORSONE con chiusura a cerniera e manici imbottiti.
- SACCA con chiusura a coulisse in corda e dotata di cinghia porta spalla.
- BEAUTY TERMICO con chiusura a cerniera.

 Polycotton

 Borsone : 49 x 34 x 20 cm

Sacca : 50 x 30 cm

Beauty : 22,5 x 14 x 15 cm

 1



**SET VIAGGIO**  
COMPOSTO  
DA BORSONE,  
SACCA  
E BEAUTY



STAMPA  
VINTAGE  
LAVILLE  
SU POLY  
COTTON

**LAVILLE PARIS****AB 0477  
BORSONE**

In cotone délavé ed ecopelle, finiture in metallo canna di fucile, tracolla e manici in ecopelle, tasca interna con chiusura a zip, ricamo vintage del marchio LAVILLE PARIS.

**i** Cotone / Ecopelle

**41 x 41 x 22 cm**

**1**

**BORSONE  
CON  
TRACOLLA  
E MANICI IN  
ECOPELLE****LAVILLE PARIS****AB 0472  
SET VIAGGIO**

Set composto da borsone e beauty con chiusura a zip, realizzato in polycotton ecru, arricchito con ricamo stile "vintage" di LAVILLE PARIS.

**i** Polycotton

**Borsone: 49 x 34 x 20 cm  
Beauty: 27 x 9 x 21 cm**



**1**

**SET VIAGGIO  
CON  
BORSONE  
E BEAUTY**



## AC 1432 TROLLEY CABINA PORTA COMPUTER E ABITI 48 ORE



In poliestere 1680 D, impermeabile e antistrappo, con struttura super light, 2 ruote con cuscinetti a sfera, chiusura con zip a doppio cursore, tascone esterno richiudibile con zip.

-  Poliestere - 2,3 kg
-  38 x 50 x 20 cm  
Vol: 40 lt
-  1



## AC 1431 ZAINO TROLLEY CABINA

In poliestere, con struttura super light, 2 ruote, chiusura con zip a doppio cursore, spallacci imbottiti a scomparsa, tascone esterno richiudibile con zip.

-  Poliestere - 2,5 kg
-  55 x 36 x 21 cm  
Vol: 44 lt
-  1





### AC 1450 TROLLEY CABINA

In poliestere 600D "two tone" con struttura super light, tsa integrato, 4 ruote girevoli con cuscinetti, chiusura con zip a doppio cursore, due tasche esterne con zip.

**i** Poliestere - 2,3 kg

**53 x 38 x 20 cm**  
Vol: 40 lt

**1**



## TROLLEY CABINA CON RUOTE GIREVOLI

CHIUSURA  
ZIP DOPPIO  
CURSORE



## Christian Lacroix

### AB 0854 BEAUTY

Beauty realizzato in poliuretano e nylon, chiusura con zip.

 Poliuretano e Nylon

 27 x 15 x 11 cm

 1



## Christian Lacroix

### AB 0853 ZAINO ELEMENT

Super leggero realizzato in morbido poliuretano nero opaco e in nylon blu scuro molto liscio e delicato. Custodia interna portcomputer e tasca con zip sul retro. L'etichetta in gomma stampata con il logo Christian Lacroix delicatamente cucito sul nylon dà un tocco giovane e casual.

 Poliuretano e Nylon

 27 x 15 x 11 cm

 1



## Christian Lacroix

### AB 0852 BORSA DA VIAGGIO ELEMENT

Super leggera realizzata in morbido poliuretano nero opaco e in nylon blu scuro molto liscio e delicato. L'etichetta in gomma stampata con il logo Christian Lacroix delicatamente cucito sul nylon dà un tocco giovane e casual.

 Poliuretano e Nylon

 51 x 25 x 28 cm

 1





**promo**solution

**MEETING  
& NOTES**

## AF 1664 ZAINO MAGNUM

Zaino in nylon con chiusura a doppia zip, tasca interna imbottita portacomputer, tasca portatablet, varie tasche interne, spallacci rebolabili imbottiti. Tasca laterale con chiusura a zip e tasca antifurto segrata sul retro con cerniera. Porta usb esterna e chiusura TSA integrata. Confezionato in elegante scatola regalo.

Max misure stampa: 150x70 mm

 Nylon - 1,66 kg

 47 x 33 x 17 cm

 1/10

## ZAINO IN POLIESTERE PER TABLET E COMPUTER



**CHIUSURA  
TSA**



**PORTA USB  
ESTERNA**



**CHIUSURA  
DOPPIA ZIP**

## SCOMPARTI IMBOTTITI



## AF 1655 ZAINO PORTACOMPUTER

Zaino in poliestere con due scomparti con chiusura a doppia zip, scomparto con interno imbottito per tablet e computer portatile 15", scomparto secondario con varie tasche interne, tre tasche esterne frontali con cerniera piu' due tasche laterali, due spallacci imbottiti e regolabili, in elegante scatola regalo.

**Max misure stampa:** 80x40 mm

**i** Poliestere - 2,52 kg

**📏** 45 x 35 x 18 cm

**🔄** 1/10

# ZAINO IN POLIESTERE PER TABLET E COMPUTER



**SPALLACCI  
REGOLABILI**



**SCOMPARTI  
IMBOTTITI  
CHIUSURE  
DOPPIA ZIP**



## AF 1659 ZAINO ANTIFURTO

Zaino business con uno scomparto principale, scomparto imbottito per laptop 15" e scomparto tablet, connettore USB, tasca segreta con cerniera sul retro.

**Max misure stampa:** 100x50 mm

 Nylon - 1kg

 45 x 35 x 11 cm

 1/4



## ZAINO ANTIFURTO



## TASCA PER COMPUTER 15"



## PORTA USB ESTERNA



## AF 1665 ZAINO PORTACOMPUTER

Zaino portacomputer 15 pollici, scomparto principale con vano imbottito per un portatile, tasche interne, vano sulla parte anteriore con chiusura lampo, manico, spallacci regolabili.

**Max misure stampa:** 110x80 mm

**i** Poliestere 600D e PVC  
0,799 kg

**1** 49 x 33 x 13 cm

**2** 1/10

# ZAINO PORTA COMPUTER 15"



**SCOMPARTO  
PRINCIPALE  
IMBOTTITO**



## AF 1669 ZAINO PORTACOMPUTER

Zaino in nylon con due scomparti, scomparto principale con interno imbottito per computer portatile, scomparto secondario con varie tasche interne, due tasche esterne frontali con cerniera e due tasche a rete sui lati, due spallacci imbottiti, manico con impugnatura ergonomica.

**Max misure stampa:** 80x40 mm

 Nylon - 0,84 kg

 45 x 30 x 15 cm

 1/10



SCOMPARTO  
PER  
COMPUTER  
IMBOTTITO



TASCHE  
ESTERNE  
A RETE  
E CON ZIP

## ZAINI IN NYLON PORTA COMPUTER

## AF 1658 ZAINO BUSINESS

Zaino con due scomparti, scomparto imbottito per laptop 15", due tasche con cerniera sul davanti e due tasche a rete sui lati.

**Max misure stampa:** 80x40 mm

 Nylon - 0,90 kg

 46 x 32 x 18 cm

 1/10



SCOMPARTO  
PER 15"  
IMBOTTITO



## AF 1663 ZAINO MARTIN

Zaino in poliestere con chiusura a doppia zip, tasca interna imbottita portacomputer, varie tasche interne, spallacci regolabili. Doppia tasca esterna con chiusura a zip. Porta usb esterna.

**Max misure stampa:** 100x50 mm

**i** Poliestere - 0,52 kg

**📏** 42 x 34 x 10 cm

**👤** 1/25



## ZAINO IN POLIESTERE



**DOPPIA ZIP  
DI CHIUSURA**



**DOPPIA TASCA  
ESTERNA CON  
CHIUSURA ZIP**



**TASCA INTERNA  
PER COMPUTER  
IMBOTTITA**

## AF 1662 ZAINO BUSINESS

Zaino con due scomparti principali, scomparto imbottito per laptop 15", tasca con cerniera sul davanti, due tasche a rete sui lati, connettore USB.

**Max misure stampa:** 100x50 mm

 Poliestere

 44 x 32 x 14 cm

 1/20



**CONNETTORE  
USB**



**SCOMPARTO  
PER 15"**





### AF 1677 BORSA PORTACOMPUTER

Porta computer primo scomparto con cerniera per portatile e 3 tasche, secondo scomparto con ampia funzione organizer a cerniera, tasca anteriore e sul retro a strappo, maniglia rinforzata a strappo, tracolla regolabile ed asportabile con parte imbottita.

Max misure stampa: 80x80 mm

 Poliestere 600D - 0,7 kg

 40 x 30 x 13 cm

 1/20

## BORSA PORTA COMPUTER CON TRACOLLA REGOLABILE



MANICI A  
SCOMPARSA

### AF 1710 PORTABLOCCO A4

Portablocco in pvc e microfibra con manici a scomparsa. Con calcolatrice e blocco carta da 20 fogli. Tasche interne portadocumenti e portacard.

Max misure stampa: 100x50 mm

 PVC / Microfibra

 34 x 25,5 x 2,5 cm

 1/15



CHIUSURA  
CON ZIP





## PORTABLOCCHI A4 CON BLOCCO E CALCOLATRICE

## AF 1716 CARTELLA A4

Cartella in tessuto poliestere con chiusura magnetica. Dotata di targhetta in metallo personalizzabile. Interno con blocco note A4 da 20 fogli a righe e portapenna (penna non inclusa), tasche per smartphone e diversi supporti per accessori come portacavi (non inclusi).

**Max misure stampa:**

190x140 mm - Targhetta 40x25 mm

-  Poliestere
-  23,3 x 31 x 1,8 cm
-  10/20





## CARTELLE A4 CON BLOCCO

## AF 1713 CARTELLA A4

Cartella in microfibra e 210D con blocco con 20 fogli a righe, elastico portapenna esterno (penna non inclusa), vari scomparti interni per bigliettini da visita, tasca per cellulare.

**Max misure stampa:** 200x200 mm

-  Microfibra 210D
-  24 x 31,5 x 1,5 cm
-  10/20



**AF 1718****PORTABLOCCO A4**

Portablocco congresso in neopel 2 ante. Chiusura con zip. Varie tasche interne per documenti, uno scomparto interno con cerniera. Una tasca esterna. Completa di blocco e calcolatrice.

**Max misure stampa:** 120x120 mm

 Neopel

 34,5 x 26 x 3 cm

 1/15

# PORTABLOCCHI A4 CON BLOCCO E CALCOLATRICE

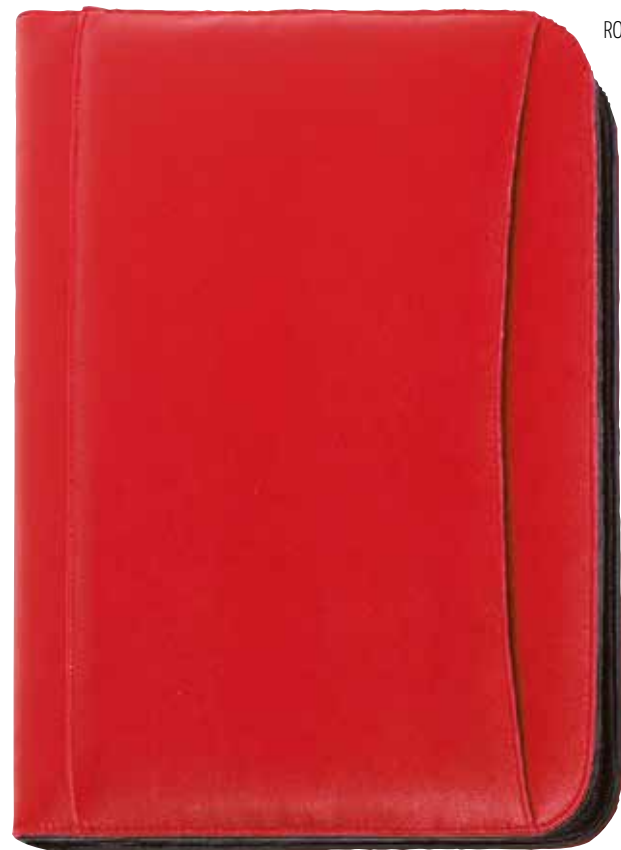



CHIUSURA  
CON ZIP

## AF 1715 PORTABLOCCO A4

formato A4 richiudibile con elastico colorato, laccetto per penna, diversi scomparti, blocco notes incluso.

Max misure stampa: 80x80 mm

-  Poliestere / PU
-  32,5 x 25 x 1 cm
-  1/20

## PORTABLOCCO A4 RICHIUDIBILE CON ELASTICO



AZ



### BLOCCO INCLUSO

RO





GR



## AF 1712 PORTABLOCCO A4

Prendi appunti in formato A4; con blocco per scrivere, anello per una penna, diverse taschine, all'esterno con laccio elastico a chiusura, interno colorato esterno nero.

Max misure stampa: 80x80 mm

-  Poliestere
-  32 x 26 x 2 cm
-  1/20



VE

AZ



GR



### INTERNO COLORATO





## PORTABLOCCO A4 RICHIUDIBILE CON ELASTICO

**AF 1725  
CARTELLINA A4**

Cartella 2 ante, con pinza portablocco.  
Confezione in polybag. (blocco notes e  
penna non inclusi).

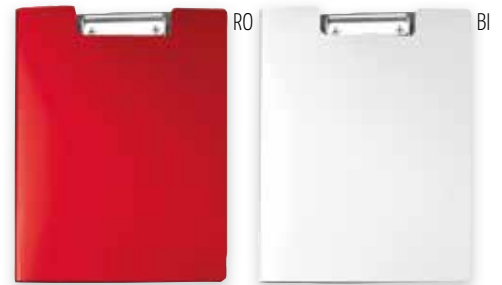

**Max misure stampa:** 190x250 mm

-  PVC
-  22 x 32 cm
-  1/50

**CARTELLINE A4****AF 1727  
CARTELLA A4**

Cartella 2 ante in poliestere, con pinza  
portablocco. Confezione in polybag.  
(blocco notes penna non inclusi).

**Max misure stampa:** 80x80 mm

-  Poliestere/Polybag
-  32,5 x 23 x 1,5 cm
-  5/25



CON PINZA  
PORTABLOCCO



# MEETING & NOTES

## AF 1735 CARTELLA PORTADOCUMENTI

Incluse 150 segnapagina adesivi in vari colori, block-notes a righe da 25 pagine, penna a sfera refill blu con fusto e clip in cartone.

**Max misure stampa:** 120x90 mm

 Cartone 600 gr

 33,7 x 26 cm

 1/40



EC

CARTELLA  
PORTA  
DOCUMENTI



CON SET  
MEMO  
PENNA E  
BLOCCO



NE

**AF 1720  
BUSTA  
PORTADOCUMENTI**

Busta portadocumenti, chiusura con bottone. Confezione in polybag.  
Max misure stampa: 280x80 mm

-  PVC
-  33,5 x 24 cm
-  20/200

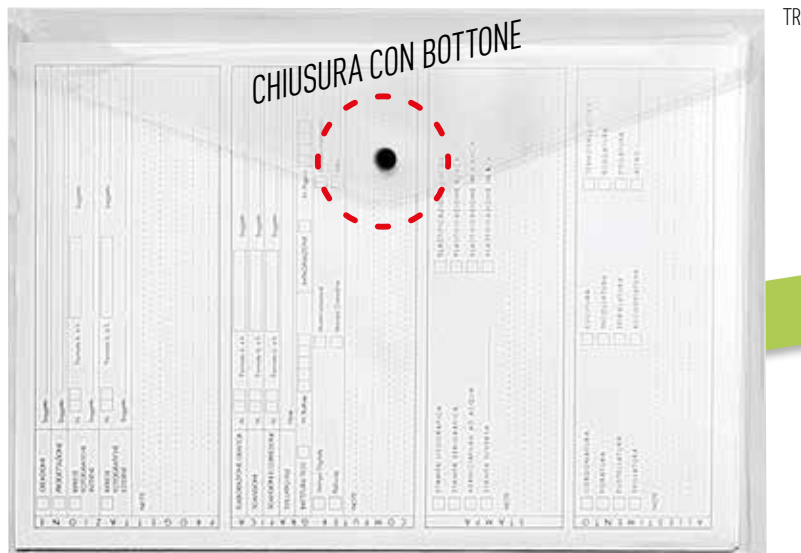

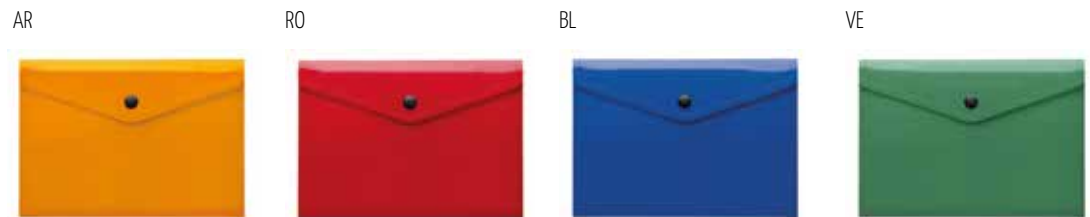

33,5x24 cm



**BUSTE PORTADOCUMENTI**

**AF 1721  
BUSTA  
PORTADOCUMENTI**

Busta portadocumenti, chiusura con bottone. Confezione in polybag.  
Max misure stampa: 190x60 mm

-  PVC
-  24 x 17 cm
-  20/300

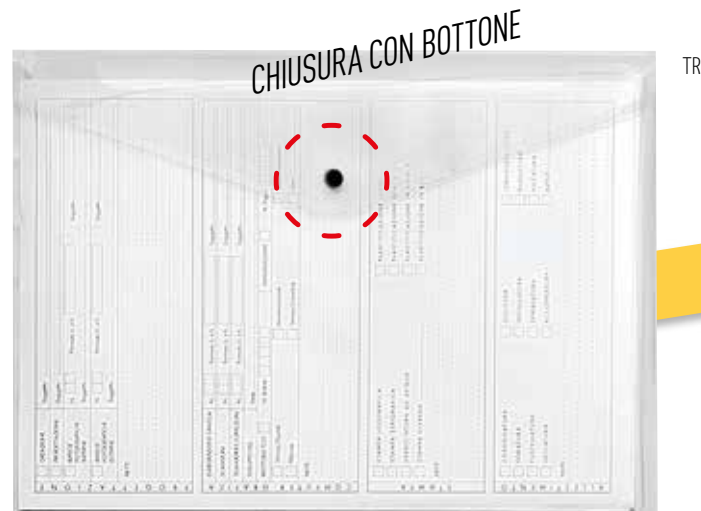

24x17 cm

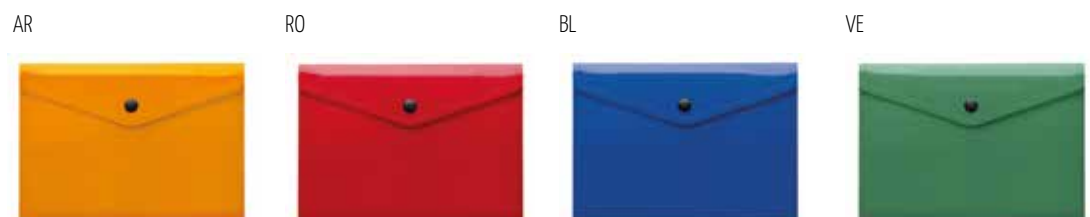



# MEETING & NOTES

## AF 1738 BLOCK NOTES A6

Blocco notes, chiusura con elastico e segnalibro. In PU colorato.

Max misure stampa: 75x80 mm

-  Poliuretano
-  9 x 14 x 1,3 cm
-  25/200



VE

**FORMATO A6**





CHIUSURA CON  
ELASTICO E  
SEGNALIBRO



## AF 1746 BLOCK NOTES A5

Blocco notes, chiusura con elastico e segnalibro. In PU colorato.

Max misure stampa: 100x80 mm

-  Poliuretano
-  14 x 21 x 1,5 cm
-  25/100



VE



**FORMATO A5**





### AF 1737 BLOCK NOTES A6

Blocco notes bianco, chiusura con elastico, 80 pagine interne a righe, segnalibro **70 g/mq**  
Max misure stampa: 60X60 mm

-  Midi Cartonato
-  14 x 9 x 1,3 cm
-  40/240





## 80 PAGINE CON RIGHE E SEGNALIBRO



### AF 1750 BLOCK NOTES A5

Blocco notes bianco, chiusura con elastico, 80 pagine interne a righe, segnalibro **70 g/mq**  
Max misure stampa: 60X60 mm

-  Midi Cartonato
-  20,7 x 14,2 x 1,3 cm
-  25/100





# MEETING & NOTES

## AF 1733 TACCUINO A6

Formato A6, copertina in PP, interno 65 pagine a righe, dotato di penna a sfera in plastica con clip in metallo, refill blu.

**Max misure stampa:** 55x30 mm

-  Polipropilene
-  15 x 13 x 1,3 cm
-  1/30





**TACCUINI  
CON  
SPIRALE**  
DOTATI DI  
PENNA  
A SFERA  
REFIL BLU

## AF 1734 TACCUINO A5

Formato A5, copertina in PP, interno 65 pagine a righe, dotato di penna a sfera in plastica con clip in metallo, refill blu.

**Max misure stampa:** 55x30 mm

-  Polipropilene
-  21 x 17,8 cm
-  1/80



## AF 1739 BLOCK NOTES

Da 60 fogli, spiralato "ECO PAPER"  
Completo di penna refill blu. Confezione  
in astuccio.

### Max misure stampa:

Penna 40x6 mm  
Block notes 55x55 mm

 Cartoncino /Metallo

 17,9 x 13,4 x 2 cm

 20/100



## BLOCK NOTES CON SPIRALE

## AF 1747 BLOCK NOTES A5

Blocco notes in cartoncino con penna,  
biodegradabile, chiusura con calamite.

Max misure stampa: Penna 60x25 mm

 Cartoncino biodegradabile

 21 x 14,7 x 1,8 cm

 25/100

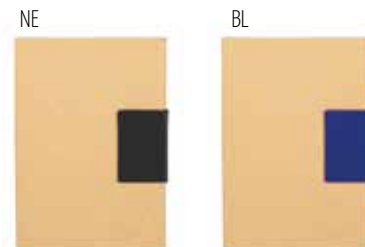

## CHIUSURA CON CALAMITA



# MEETING & NOTES

## AF 1743 BLOCK NOTES A6

Blocco notes in cartoncino con penna, biodegradabile, chiusura con elastico.

Max misure stampa: 45x30 mm

 Cartoncino biodegradabile

 14 x 9,8 x 0,9 cm

 50/200



## BLOCK NOTES BIODEGRADABILI

## AF 1742 BLOCK NOTES

Blocco notes in cartone, 80 fogli a righe, penna a sfera refill nero con fusto in cartone.

Max misure stampa: Penna 40x6 mm

Block notes 60x35 mm

 Cartoncino

 8,9 x 11,1 cm

 50/200



AZ



NE



AR



VE



RO

## CON PENNA IN CARTONCINO

## AF 1744 BLOCK NOTES

Block notes A7 con 140 pagine di carta riciclata, copertina rigida in cartone ed elastico. Include matita con gomma sulla punta.

Max misure stampa: 40x80 mm

 Carta

 8,2 x 10,5 cm

 20/160





## AF 1760 MINI QUADERNO

Quaderno in "ECO PAPER" con post-it, penna a sfera refill nero.

Max misure stampa: 25x40 mm

 ECO PAPER

 10,5 x 8 cm

 100/400



IN ECOPAPER CON  
PENNA E POST-IT





## AF 1763 MEMOBOX

Memo con foglietti adesivi e scomparto per bigliettini da visita, richiudibile con elastico, in materiale riciclato.

Max misure stampa: 20x70 mm

 Cartoncino riciclato

 10,5 x 6,8 cm

 100/500



CHIUSURA  
CON ELASTICO  
IN CARTONCINO  
RICICLATO





## AF 1764 SET MEMO

Memo con spirale, 125 memo stick rettangolari in vari colori, 100 memo stick quadrati in vari colori.

Max misure stampa: 50x35 mm

 Cartone/Metallo

 7,5 x 8 x 2,5

 25/200



100 MEMO IN  
VARI COLORI



# MEETING & NOTES

## AF 1762 MEMOBOX

Memo con 120 foglietti, 20 graffette in scomparto nascosto, 100 bandierine segnalibro colorate, penna a sfera mini refill nero, copertina in cartone riciclabile.

**Max misure stampa:** 60x60 mm

 **Cartone/Plastica**

 **16,5 x 10,4 x 2,2 cm**

 **25/100**



MEMO CON  
120 FOGLIETTI  
CON GRAFFETTE  
E MINI PENNA

## AF 1759 SET MEMO

Set Memo Con righello 13 cm integrato, memo stick in 4 formati ed in vari colori, penna a sfera con corpo in cartone, refill blu.

**Max misure stampa:** 60x30 mm

 **Cartoncino riciclato**

 **16 x 8 x 1,2 cm**

 **50/200**



SET MEMO CON  
RIGHELLO 13 CM

## AF 1758 SET MEMO

Set memo in cartone a forma di casa con foglietti interni e memo stick esterni in vari colori.

**Max misure stampa:** 60x30 mm

 **Carta/Cartone/PET**

 **11,0 x 9,0 x 6,3 cm**

 **20/40**



CON FOGLIETTI  
E MEMO STICK



### AF 1755 CUBO DA SCRIVANIA

Cubo da scrivania multiuso, in cartone. contiene piccoli memo stick in 5 colori diversi e grandi memo stick, vano utilizzabile come porta penne.

**Max misure stampa:** 50x35 mm

 Carta

 8,0 x 8,0 x 7,7 cm

 1/50



CON PICCOLI  
E GRANDI  
MEMO STICK



### AF 1756 SET MEMO

Da scrivania in carta con blocco note con foglietti adesivi e penna in cartone e plastica, 50 fogli promemoria per colore, le prime cinque pagine del blocco note sono stampate con planning settimanale, le altre pagine sono bianche.

**Max misure stampa:**  
clip penna: 30x6 mm  
planning: 55x35 mm

 Carta

 31,0 x 17,4 x 0,8 cm

 30/120



CON  
PENNA  
BLOCCO  
NOTE E  
FOGLIETTI  
ADESIVI





## AF 1769 PORTAFOGLIETTI

Portafoglietti in plastica in pvc con 900 fogli bianchi (80 g/m<sup>2</sup>).

Max misure stampa: 50x30 mm

 PVC/ Carta

 9,0 x 9,0 x 9,0 cm

 30/60

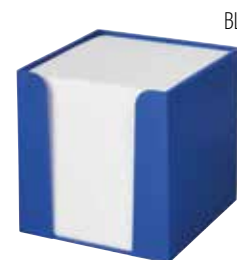

## AF 1767 CUBO CARTA

Cubo in carta bianca usomano.

 Carta

 9,6 x 9,6 x 9,6 cm

 24/96

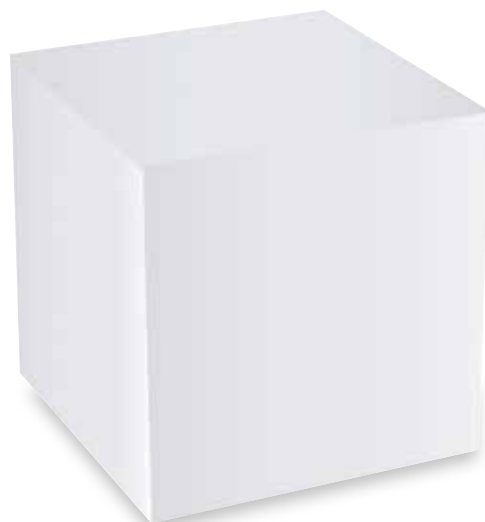

## CUBO CARTA USOMANO

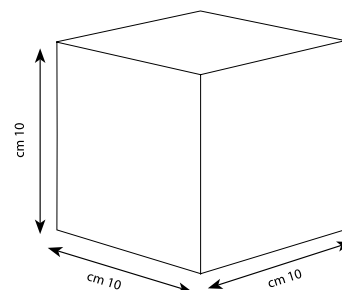

## AF 1768 MINI CUBO PORTAPENNA

Cubo in carta bianca usomano con cartoncino portapenna.

 Carta

 11,5 x 11,5 x 3,8 cm

 12/120



## CUBO CARTA PORTA PENNA

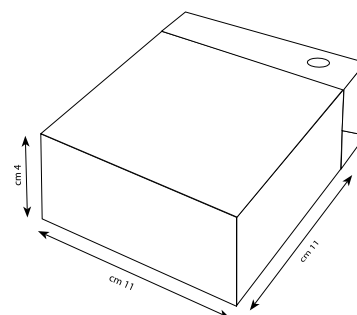



**promo**solution

**PENNE**



**maxema®**

Luce allo stato puro, impregiosita da un tocco di colore. Lasciati conquistare da Mood Metal, la nostra penna in metallo con finitura a specchio diamantata.

QUALITY NOT QUANTITY

**MADE IN ITALY**



Prodotta con tecniche artigianali di altissima qualità



Tutti i modelli Mood Metal vengono forniti con Astuccio singolo in cartoncino nero Fedrigoni 280 gr/m<sup>2</sup> personalizzabile con stampa tampografica



### AL 2117 MOOD METAL

Penna con meccanismo a scatto, con molla di ritorno tappino, fusto e punta in metallo, lavorati singolarmente con finitura diamantata, clip in colore coprente, realizzata in plastica ABS atossica e ad alta resistenza. Refill "tipo Parker" nero.

#### Max misure stampa:

Laser fusto: 30 x 7 mm

Tampografia clip: 40 x 9 mm

 Metallo/Plastica ABS atossica

 25/100



SI/NE



GR/BG



GR/NE



ORO/NE

IL DESIGN MADE IN ITALY  
FUSTO E PUNTA IN METALLO  
FINITURA DIAMANTATA

 PARKER



**JOTTER**



 PARKER

**AL 2148  
PARKER JOTTER**

Parker, penna a sfera Jotter in acciaio inossidabile e plastica, finiture cromate, meccanismo a scatto, elegante confezione regalo. Refil blu.

**Max. misure stampa:**

Serigrafia monocolore fusto: 35 x 12 mm  
Stampa UV: 40 x 5 mm

-  **ABS/ Metallo**
-  **18,0 x 5,5 x 3,7 cm**
-  **1/50**



**UN BRAND  
CLASSICO**  
COMPLETO  
DI BOX REGALO



 PARKER

**AL 2147  
PARKER JOTTER**

Parker, penna a sfera Jotter in acciaio inossidabile e plastica, finiture cromate, meccanismo a scatto, elegante confezione regalo. Refil nero.

**Max. misure stampa:**

Serigrafia monocolore fusto: 35 x 12 mm  
Stampa UV: 40 x 5 mm

-  **ABS/ Metallo**
-  **18,0 x 5,5 x 3,7 cm**
-  **1/50**





## AL 2138 PARKER IM

Penna roller in ottone laccato con finiture cromate.  
Corredata di astuccio. Refil Nero.

**Max. misure stampa:**

Laser o stampa UV fusto: 40 x 6 mm

Ottone

1,1 x 13,5 cm

1/10



## AL 2134 PARKER IM

Penna biro in ottone laccato con finiture cromate.  
Corredata di astuccio. Refil Blu.

**Max. misure stampa:**

Laser o stampa UV fusto: 40 x 6 mm

Ottone

1,1 x 13,5 cm

1/10



## AL 2130 PARKER JOTTER

Penna in acciaio con meccanismo a scatto. Refil blu. Confezione in astuccio.

**Max. misure stampa:**

Laser o stampa UV fusto: 40 x 6 mm

Acciaio

1,3 x 12,8 cm

1/20



HUGO BOSS



  
FESTINA

# PENNE



**FESTINA**

## AL 2116 PENNA BIRO FESTINA

in alluminio con una texture spazzolata e dettagli metallici cromati, la penna a sfera Chronobike, unisce un look sportivo a una sensazione raffinata. Refil nero.

**Max misure stampa:**

Laser o stampa UV fusto: 35 x 7 mm

 Alluminio

 13,9 x 1,3 cm

 1/10



UNA BIRO  
SPORTIVA  
LAVORATA  
IN ALLUMINIO



## HUGO BOSS

### AL 2109 BIRO HUGO BOSS

Penna biro in ottone rivestita in rubber soft touch con finiture in metallo laccato nero opaco. Confezione in astuccio. Refil blu.

 Ottone rivestito in rubber

 1/10



BIRO IN  
OTTONE  
RIVESTITA  
IN RUBBER  
SOFT TOUCH

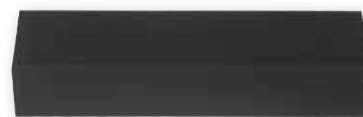



**HUGO BOSS****AL 2114****PENNA HUGO BOSS**

Penna roller in ottone realizzata con un raffinato motivo a spina di pesce, impreziosita da particolari cromati. Corredata di astuccio. Refil nero.

 **Ottone**
 **1/10**
**HUGO BOSS ROLLER  
CON ASTUCCIO****HUGO BOSS****AL 2115****PENNA BIRO HUGO BOSS**

In alluminio con una texture spazzolata e dettagli metallici cromati. Refil blu.

 **Alluminio**
 **1/10**
**HUGO BOSS BIRO  
CON ASTUCCIO**

**LAVILLE®**  
PARIS

**AL 2161**  
**PENNA**  
**MULTIFUNZIONE**

Un pratico accessorio realizzato in metallo cromato e satinato che combina 4 differenti funzioni: Portachiavi - Penna a sfera - Puntatore "touch" - Gettone per carrello spesa. Confezionato in una prestigiosa confezione in metallo argentato.

 Metallo

 1/20



PENNA **LAVILLE**  
MULTIFUNZIONI

**AL 2170**  
**EVERTON**

Penna a sfera multifunzione in metallo con clip. Penna a sfera con puntatore laser, punta touch e mini torcia a LED. Fornita con 3 batterie incluse in astuccio in metallo. Refil blu.

 Metallo

 17,8 x 3,8 x 1,9 cm

 50/500



**AL 2216  
ATENE**

Penna a sfera in alluminio con touch,  
fusto in gomma, custodia in alluminio.  
Refil nero.

**Max misure stampa:**

Stampa UV Fusto: 50x25 mm

Stampa UV Custodia: 40x20 mm

 Alluminio

 1,0 x 14,4 cm

 50/500

# BIRO COMPLETA DI ASTUCCIO



NE



GR



BL



RO



# PENNE

## AL 2190 STOCCOLMA

Penna in alluminio con fusto verniciato e finiture nero opaco. Refil nero.

### Max misure stampa:

Laser o stampa digitale fusto: 50x6 mm

 Alluminio

 50/500



## AL 2155 PORTO

Penna a sfera in alluminio con meccanismo a rotazione. Refil blu

 Alluminio

 50/500





**AL 2165  
TOKYO**

Penna a sfera touch in alluminio, refill blu.

**Max. misure stampa:**

Laser o digitale: 45 x 6 mm

-  Alluminio
-  Ø 0,9 x 12,5 cm
-  50/500

TOUCH  
SCREEN**AL 2175  
LEIDA**

Penna sfera in metallo laccato, clip e puntale in tinta con l'impugnatura a strisce in gomma, meccanismo a scatto, refill blu.

**Max. misure stampa:**

Laser o digitale: 40 x 6 mm

-  Metallo
-  Ø 0,9 x 12,5 cm
-  50/500



# PENNE

## AL 2180 SMART

Penna a sfera touch sottile in alluminio lucido. Refil nero.

**Max. misure stampa:**

Laser o digitale su fusto: 45 x 5 mm

 Alluminio/Gomma/Metallo

 50/500



TOUCH  
SCREEN



## AL 2185 SALVADOR

Penna a sfera in alluminio finitura in gomma con touch. Refil blu.

**Max. misure stampa:** 35x5 mm

 Alluminio/ Metallo

 14,3 x 1,4 cm

 50/500



TOUCH  
SCREEN



**AL 2200  
BAHAMAS**

Penna a sfera con touch, fusto in alluminio doppio strato di laccatura: primo strato nero e secondo strato dello stesso colore del touch, refill nero.

**Max. misure stampa:**

Laser su fusto: 50 x 6 mm

 Alluminio

 50/500

**PENNA  
CON TOUCH  
REFIL NERO**  
INCIDENDO  
CON IL LASER  
IL LOGO ASSUME  
LO STESSO  
COLORE DEL  
GOMMINO TOUCH

**AL 2188  
MAURITIUS**

Penna a sfera in alluminio con doppio strato di verniciatura: primo strato nero matt e strato sottostante con verniciatura colorata lucida che permette che consente la realizzazione dell'incisione laser. Refil blu.

**Max. misure stampa:**

Laser su fusto: 50 x 6 mm

 Alluminio

 50/500

**PENNA  
REFIL BLU**  
INCIDENDO  
CON IL LASER  
IL LOGO ASSUME  
LO STESSO  
COLORE DEL  
PULSANTE



# PENNE

## AL 2192 BREMA

Penna a sfera in alluminio con Refil nero.

**Max. misure stampa:**

Laser su fusto: 45 x 6 mm

Stampa digitale: 45 x 5 mm

 Alluminio

 50/500



## AL 2195 AMBURGO

Penna a sfera touch in alluminio. Refil nero.

**Max. misure stampa:**

Laser su fusto: 45 x 6 mm

Stampa digitale: 45 x 5 mm

 Alluminio

 50/500



TOUCH  
SCREEN



**AL 2253  
MONACO**

Penna a sfera in plastica con particolari in metallo. Refil nero.

**Max. misure stampa:**

Digitale: 45 x 5 mm

 **Plastica e metallo**

 **50/1000**

**AL 2251  
COLONIA**

Penna a sfera touch in plastica con particolari in metallo. Refil nero.

**Max. misure stampa:**

Digitale: 45 x 5 mm

 **Plastica e metallo**

 **50/1000**



 TOUCH SCREEN



LA TERRA È PIENA DI SFUMATURE



**maxema**<sup>®</sup>

IL DESIGN INCONTRA  
LA SOSTENIBILITÀ



La plastica delle penne deriva al 100% da prodotti post-consumo WEEE, è certificata e conforme alle normative RoHS e REACH



4 Km di scrittura con una sola penna



Materiali non solo riciclati, ma anche riciclabili.



maxema®

### AL 2121 ICON PURE

Penna in plastica riciclata, atossica ed ad alta resistenza colori coprenti con finitura satinata. Meccanismo a rotazione. Refill Jumbo, inchiostro blu e nero. La stampa deve essere eseguita prima della gommatura o, in alternativa, con inchiostri specifici per superfici gommate

**Max dimensioni stampa:**

Serigrafia Fusto: 45x30 mm

 **Plastica riciclata**

 **50/100**



BI

NE

GRC

VE

BL

GR

BG

MA



maxema®

### AL 2123 DOT

Penna in plastica riciclata, atossica e ad alta resistenza, colori coprenti con finitura satinata, piccola sfera in colore coprente lucido. Meccanismo a scatto, con molla di ritorno. La cromatura e la doratura del tappino sono ottenute con trattamento galvanico. Refill Jumbo, inchiostro blu e nero.

**Max dimensioni stampa:**

Serigrafia Fusto: 40x30 mm

Tampografia Fusto: 50x9 mm

Tampografia Clip: 40x9 mm

 **Plastica riciclata**

 **50/100**



# PENNE



## AL 2128 BAY

Penna con meccanismo a rotazione realizzata in plastica ABS, atossica e ad alta resistenza, refill X-20, inchiostro blu e nero, superficie satinata.

### Max. misure stampa:

Tampografia Fusto: 60x7 mm

Clip: 30x7 mm

Serigrafia Fusto in linea con la clip: 50x28 mm

 Plastica

 100/1000



## L'ESSENZA DEL DESIGN MADE IN ITALY



**AL 2235  
LILIA**

Penna a sfera in plastica solid e clip in metallo, refill nero.

**Max misure stampa:**  
Serigrafia: 35 x 15 mm  
Digitale: 45 x 5 mm

 **Plastica e Metallo**

 **50/1000**

**AL 2240  
LILIA GOLD**

Penna a sfera in plastica solid e dorata, clip in metallo. Refill nero.

**Max misure stampa:**  
Vicino clip: 30 x 5 mm  
Fusto: 50 x 15 mm

 **Plastica e Metallo**

 **50/1000**



PENNE  
A SFERA  
MADE  
IN ITALY



# PENNE



## AL 2225 PENNA S!

Penna a sfera In ABS bianco con particolari colorati. Refil blu.

**Max misure stampa:**  
Serigrafia: 35 x 15 mm  
Digitale: 45 x 8 mm

 ABS

 100/1000



PENNE  
A SFERA  
MADE  
IN ITALY



## AL 2223 PENNA BARON

Penna a sfera In ABS bianco con particolari colorati. Refil blu.

**Max misure stampa:**  
Serigrafia: 35 x 15 mm  
Digitale: 45 x 7 mm

 ABS

 100/1000



**AL 2228  
EXTRA SOLID**

Penna a sfera in ABS atossico e clip trasparente frost in Terlux atossico. Scrittura 2 Km - Sfera Ø 1 mm. Inchiostro Dokumental atossico. Refil blu.

 ABS

 100/1000



CLIP  
TRASPARENTE

**AL 2229  
EXTRA RECYCLED**

Penna a sfera in ABS riciclato atossico. Scrittura 2 Km - Sfera Ø 1 mm. Inchiostro Dokumental atossico. Refil blu.

 ABS

 100/1000



PENNE  
A SFERA  
**MADE  
IN ITALY**



IN ABS  
ATOSSICO  
**100%  
RICICLATA**

# PENNE

## AL 2345 VALENCIA

Penna a sfera in bamboo biodegradabile, particolari in ABS, refill blu.

**Max misure stampa:**

Serigrafia: 35 x 15 mm

Digitale: 45 x 6 mm

 Bamboo

 50/1000



## PENNA IN BAMBOO

BIODEGRADABILE



## AL 2347 BILBAO

Penna a sfera in bamboo con particolari in metallo. Refill blu.

**Max misure stampa:**

Serigrafia: 35 x 15 mm

Digitale: 45 x 7 mm

 Bamboo

 50/1000



## PENNA IN BAMBOO CON PARTICOLARI IN METALLO



**AL 2340  
MADRID**

Penna a sfera in cartone biodegradabile, particolari in ABS, refill blu.

**Max misure stampa:**

Serigrafia: 35 x 15 mm

Digitale: 45 x 7 mm

 Cartone

 50/1000



CARTONE BIODEGRADABILE

**PENNE  
A SFERA****AL 2342  
SIVIGLIA**

Penna a sfera realizzata in cartone riciclato con particolari in fibra di grano e ABS. Refill blu.

**Max misure stampa:**

Serigrafia: 35 x 15 mm

Digitale: 45 x 7 mm

 Cartone

 50/1000



CARTONE RICICLATO



# PENNE

## AL 2242 BOSTON

Penna sfera in plastica con touch e led interno a luce bianca, apertura a rotazione, refill blu.

**Max misure stampa:**

Incisione laser: 35 x 7 mm

 **Plastica e metallo**

 **50/1000**



## PENNA CON LED INTERNO

## TOUCH SCREEN



## AL 2246 CUBA

Penna a sfera touch in plastica con particolari in metallo. Refil nero.

**Max misure stampa:**

Serigrafia: 35 x 15 mm

Digitale: 50 x 7 mm

 **Plastica e Metallo**

 **50/1000**



LEGGERMENTE APPIATTITA  
PER FACILITARE LA STAMPA DIGITALE

## TOUCH SCREEN



**AL 2245  
BROOKLYN**

Penna a sfera touch in plastica e metallo refill nero.

**Max misure stampa:**

Serigrafia: 35 x 15 mm

Digitale: 50 x 7 mm

 Plastica e Metallo

 50/1000

**PENNA  
A SFERA  
TOUCH  
SCREEN**

# PENNE

## AL 2255 AMALFI

Penna in plastica con clip in metallo.  
Refil nero. Impugnatura in plastica  
gommata.

**Max misure stampa:**

Serigrafia: 35 x 15 mm

Digitale: 50 x 7 mm

 **Plastica e Metallo**

 **50/1000**



**AL 2258  
VIETRI**

Penna in ABS antibatterico con clip in metallo. Impugnatura traslucida. Refil Nero.

**Max misure stampa:**

Serigrafia: 35 x 15 mm

Digitale: 50 x 7 mm

 **ABS antibatterico**

 **50/1000**



# PENNA BIRO IN ABS ANTIBATTERICO



## AL 2256 POSITANO

Penna in plastica semitrasparente con clip in metallo. Refil nero. Impugnatura in plastica gommata.

### Max misure stampa:

Serigrafia: 35 x 15 mm

Digitale: 50 x 7 mm

 **Plastica e Metallo**

 **50/1000**

## PENNA A SFERA CON CLIP IN METALLO



**AL 2254  
NEW YORK**

Penna a sfera in plastica silver con particolari in metallo. Refil nero.

**Max misure stampa:**

Serigrafia: 35 x 15 mm

Digitale: 50 x 7 mm

 **Plastica e Metallo**

 **50/1000**

**BIRO SILVER  
CON  
PARTICOLARI  
IN METALLO**

## AL 2248 LONDRA

Penna a sfera touch in plastica con clip in metallo e refill nero.

**Max misure stampa:**

Serigrafia: 35 x 15 mm

Digitale: 50 x 5 mm

 **Plastica e Metallo**

 **50/1000**

## PENNA A SFERA CON TOUCH SCREEN





**AL 2272  
LIVERPOOL**

Penna ink-gel in plastica bianca con particolari colorati, chiusura con tappo. Refil nero.

**Max misure stampa:**  
Serigrafia: 35 x 15 mm  
Digitale: 40 x 6 mm

 Plastica

 50/1000

**PARTICOLARI  
COLORATI**

**PENNA INK-GEL**

# PENNE

## AL 2268 MANCHESTER

Penna a scatto in plastica bianca con particolari colorati. Refil nero.

**Max misure stampa:**  
Serigrafia: 35 x 15 mm  
Digitale: 40 x 6 mm

 Plastica

 50/1000



## PARTICOLARI COLORATI

## AL 2301 ATLANTA

Penna sfera con fusto in ABS bianco con finiture colorate. Refil nero.

**Max misure stampa:**  
Serigrafia: 35 x 15 mm  
Digitale: 40 x 6 mm

 Plastica

 50/1000



**AL 2325  
NEW JERSEY**

Penna a sfera in plastica con impugnatura in gomma. Refil nero.

**Max misure stampa:**  
Serigrafia: 35 x 15 mm  
Digitale: 50 x 6 mm

 Plastica

 50/1000



## IMPUGNATURE GOMMATE

**AL 2310  
PORTORICO**

Penna a sfera in plastica con impugnatura in gomma. Refil nero.

**Max misure stampa:**  
Serigrafia: 35 x 15 mm  
Digitale: 40 x 7 mm

 Plastica

 50/1000



# PENNE

## AL 2326 SANTIAGO

Penna sfera con corpo in plastica. Refil nero.

**Max misure stampa:**  
Serigrafia: 35 x 15 mm  
Digitale: 45 x 6 mm

 Plastica

 50/1000



**SANTIAGO**  
CON  
FINITURE  
**A COLORI**



## AL 2327 VIENNA

Penna sfera con fusto in plastica. Refil nero.

**Max misure stampa:**  
Serigrafia: 35 x 15 mm  
Digitale: 45 x 6 mm

 Plastica

 50/1000



**VIENNA**  
BIRO CON  
FUSTO IN  
**7 COLORI**



**AL 2320  
CIPRO**

Penna sfera con fusto in plastica con finiture cromate. Refil nero.

**Max misure stampa:**

Serigrafia: 35 x 15 mm

Digitale: 45 x 6 mm

 Plastica

 Ø 0,9 x 14,1 cm

 50/1000



PENNA IN  
PLASTICA  
CON  
FINITURE  
CROMATE

**AL 2305  
FLORIDA**

Penna sfera in ABS colorato con finiture bianche. Refil blu.

**Max misure stampa:**

Serigrafia: 35 x 15 mm

Digitale: 40 x 6 mm

 Plastica

 50/1000

PENNA IN  
ABS CON  
FUSTO  
COLORATO



MECCANISMO  
A ROTAZIONE

# PENNE

## AL 2276 ZURIGO

Penna sfera in plastica con meccanismo a rotazione. Refil nero.

**Max misure stampa:**

Serigrafia: 35 x 15 mm

Digitale: 40 x 6 mm

 Plastica

 50/1000



## MECCANISMO A ROTAZIONE

## AL 2280 NEW CASTLE

Penna a sfera in plastica con meccanismo a rotazione e finitura metallica. Refil blu.

**Max misure stampa:**

Serigrafia: 35 x 15 mm

Digitale: 45 x 6 mm

 Plastica

 50/1000



**AL 2360  
MANILA**

Penna a sfera in plastica argentata e solid, refill nero.

**Max misure stampa:**

Serigrafia: 35 x 15 mm

Digitale: 40 x 6 mm

 Plastica

 50/1000

**PENNA A SFERA IN PLASTICA**

AR



SI



GI



BL



BI



BO



VE



NE

# PENNE

## AL 2355 MITO

Penna a sfera in plastica con clip in metallo. Refil nero.

**Max misure stampa:**  
Serigrafia: 35 x 15 mm  
Digitale: 40 x 6 mm

 **Plastica e Metallo**

 **50/1000**

## BIRO CON CLIP IN METALLO





**AL 2350  
OSAKA**

Penna in plastica con clip in metallo.  
Refil Nero.

**Max misure stampa:**

Serigrafia: 35 x 15 mm

Digitale: 40 x 6 mm

 Plastica

 50/1000



BL



RS



RO



Gi



VE



RY



NE



AR



VM



# PENNE

## AL 2370 STILOFORO

Con penna in plastica, cordino a spirale.  
Refil blu.

**Max misure stampa:**



Tampografica monocolore: 30 x 10 mm

-  Plastica
-  16,3 x 5,4 x 4 cm
-  20/120



## AL 2365 KIEV

Penna a sfera in plastica con 4 refil:  
blu, rosso, verde e nero.

-  Plastica
-  Ø 1,3 x 13,8 cm
-  50/1000

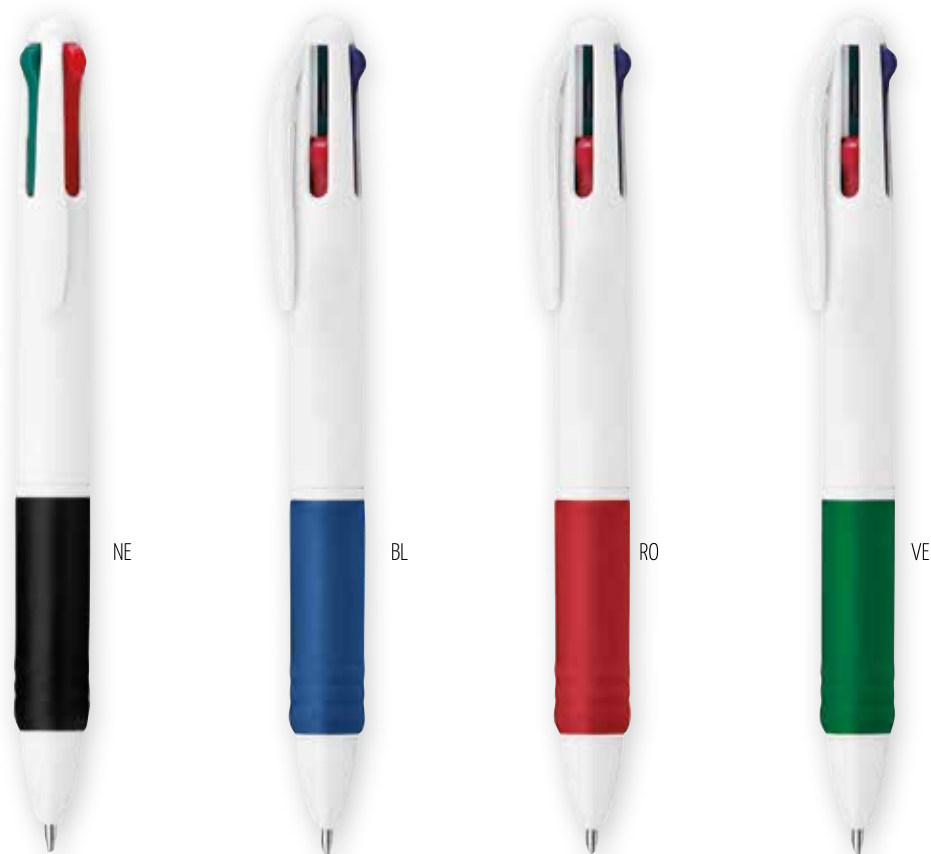

**AL 2250  
BERLINO**

Mini penna a sfera touch con portachiavi in plastica refill nero.

**Max misure stampa:**

Serigrafia: 30 x 12 mm

 Plastica

 8 cm

 50/1000

PORTACHIAVI MINIPENNA **TOUCH****AL 2373  
PENNA DOCTOR**

Penna a sfera siringa con refill nero.

**Max misure stampa:**

Serigrafia: 35 x 15 mm

 Plastica

 Ø 1,1 x 12,8 cm

 50/1000



# PENNE

## AL 2375 MATITA

Matita in legno colorato con gomma.

**Max misure stampa:**

Serigrafia: 50 x 1 mm

Digitale: 55 x 5 mm

 Legno

 100/2000

## AL 2378 MATITA

Matita in legno naturale con gomma.

**Max misure stampa:**

Serigrafia: 50 x 1 mm

Digitale: 55 x 5 mm

 Legno

 100/2000



# MATITE IN LEGNO MULTICOLOR



# MATITE IN LEGNO CON GOMMA COLORATA

**AL 2377  
MATITA**

Matita antibatterica bianca in legno non temperata con gomma. Logo antibatterico stampato sulla parte superiore della matita.

**Max misure stampa:**

Serigrafia: 50 x 1 mm

Digitale: 55 x 5 mm

 Legno

 100/2000

**AL 2381  
MATITA**

ALL BLACK

**Max misure stampa:**

Serigrafia: 50 x 1 mm

Digitale: 55 x 5 mm

 Legno

 50/1000

**AL 2382  
MATITA**

ALL BLACK con gomma.

**Max misure stampa:**

Serigrafia: 50 x 1 mm

Digitale: 55 x 5 mm

 Legno

 60/600



# PENNE

## AL 2505 SET 12 MATITE

Colorate, in astuccio cilindrico in cartone, coperchio in plastica con temperamatite

**Max misure stampa:**

Serigrafia: 35 x 15 mm

Digitale: 35 x 8 mm

 Legno/ Carta

 Ø 3,5 x 10,7 cm

 20/200

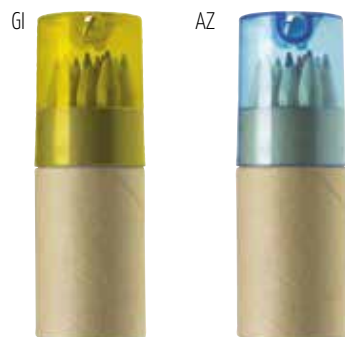

## AL 2506 SET 6 MATITE

Colorate, in astuccio cilindrico in cartone, coperchio in plastica con temperamatite.

**Max misure stampa:**

Serigrafia: 35 x 15 mm

Digitale: 35 x 8 mm

 Legno/ Carta

 Ø 2,7 x 10,3 cm

 48/480

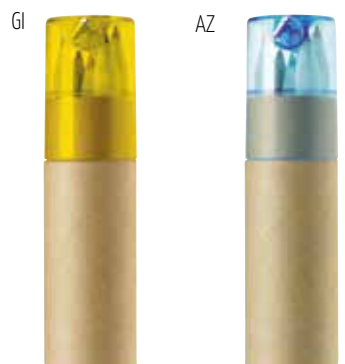

## AL 2388 SET DISEGNO

Set 10 matite in legno con righello e temperamatite e con libricino da colorare.

**Max misure stampa:**

Serigrafia: 30 x 12 mm

 Legno/ Carta

 18 x 7,5 x 1,2 cm

 50/200



## AL 2389 SET 6 MATITE

Set 6 matite corte colorate, confezione in cartoncino.

**Max misure stampa:**

Serigrafia o digitale: 30 x 50 mm

 Legno/ Carta

 4,5 x 9 x 0,9 cm

 48/960



**AL 2410  
SET ARTE**

56 pezzi, pennarelli, acquarelli,  
matite, pastelli, temperamatite e  
gomma, in cofanetto.

**Max misure stampa:**

Serigrafia: 50 x 20 mm

 Plastica / Carta

 19,5 x 10,0 cm

 1/12



# PENNE

## AL 2424 ASTUCCIO

Astuccio portapenne con chiusura lampo.

**Max misure stampa:**

Serigrafia: 60 x 35 mm

 Poliestere 420D

 21,0 x 9,5 x 0,1 cm

 50/200

RO



AR



GI



NE



BL



VE



BI



## AL 2431 GOMMA

Gomma con temperamatite.

**Max misure stampa:**

Serigrafia: 20 x 25 mm

 Plastica / Carta

 6,4 x 3,4 x 1,7 cm

 24/240



## GOMMA CON TEMPERAMATITE

RO



VE



BL



BI





**promo**solution

**ACCENDINI**

# ACCENDINI

## AM 2530 ACCENDINO

In plastica solid FLUO ricaricabile.  
Confezione da 25 pz. in colori assortiti.

**Max Misure Stampa:**

Serigrafia e Digitale 45x15 mm

 Plastica Fluo

 8 x 3 cm

 25/250

## ACCENDINI IN PLASTICA RICARICABILI

**FLUO**



## AM 2524 ACCENDINO

Accendino in plastica ricaricabile.

**Max Misure Stampa:**

Serigrafia e Digitale 35x20 mm

 Plastica

 6,5 x 3,5 cm

 30/600



## AM 2528 ACCENDINO

in plastica ricaricabile. Confezione da  
25 pz in colori metallici assortiti.

**Max Misure Stampa:**

Serigrafia e Digitale 45x15 mm

 Plastica

 8 x 3 cm

 25/250



**AM 2552  
ACCENDINO**

Tascabile con astuccio in cartoncino.

**Max Misure Stampa:**

Laser 25x25 mm

 Metallo

 5,6 x 3,6 cm

 12/120

**ACCENDINI TASCABILI ASTUCCIO IN CARTONCINO**



**AM 2525  
ACCENDINO**

Piezo in plastica soft touch, ricaricabile.

**Max misure stampa:**

Serigrafia e Digitale 40x20 mm

 Plastica

 6,3 x 3,5 x 1,4 cm

 30/600



SOFT  
TOUCH



**AM 2556  
ACCENDINO**

Accendino in plastica con fiamma turbo antivento.

**Max Misure Stampa:**

Digitale 30x20 mm

 Plastica

 6,6 x 4 x 1,9 cm

 10/100

FIAMMA TURBO  
ANTIVENTO





# ACCENDINI

## AM 2515 ACCENDINO

Piezo in plastica, ricaricabile.

**Max Misure Stampa:**

Serigrafia e Digitale 45x14 mm

-  Plastica
-  8 x 2,4 cm
-  50/1000



RO



GI

AR

BL

BI

NE

VM

VE



**Ricaricabili**

## AM 2514 ACCENDINO

Piezo in plastica, ricaricabile.

**Max Misure Stampa:**

Serigrafia e Digitale 50x14 mm

-  Plastica
-  8,2 x 2,6 x 1,2 cm
-  50/1000



NE



GR

BL

RO

GI

VE

SI

BI



**Ricaricabili**

## AM 2516 ACCENDINO

Piezo in plastica, ricaricabile.

**Max Misure Stampa:**

Serigrafia e Digitale 45x14 mm

-  Plastica
-  8 x 2,5 cm
-  50/1000



RO



AR

BL

NE



VE

**AM 2518  
ACCENDINO**

A pietra focaia in plastica neon.  
Confezione da 50 pz. in colori assortiti.

**Max Misure Stampa:**

Serigrafia e Digitale 45x14 mm

-  Plastica
-  8 x 2,3 cm
-  50/1000





CONFEZIONE CON COLORI ASSORTITI

**AM 2520  
ACCENDINO**

A pietra focaia in plastica.

**Max Misure Stampa:**

Serigrafia e Digitale 45x14 mm

-  Plastica
-  8 x 2,4 cm
-  50/1000





ACCENSIONE CON PIETRA FOCAIA

**AM 2519  
ACCENDINO  
APRIBOTTIGLIE**

In plastica a pietra.

**Max Misure Stampa:**

Serigrafia e Digitale 45x14 mm

-  Plastica
-  9 x 2,4 cm
-  50/1000



CON APRIBOTTIGLIE

# ACCENDINI

## AM 2540 ACCENDIGAS

In plastica ricaricabile.

**Max Misure Stampa:**

Serigrafia e Digitale 35x20 mm

-  Plastica
-  10,5 x 3,2 cm
-  28/280

BI



NE





## RICARICABILI

## AM 2569 POSACENERE IN CERAMICA

**Max Misure Stampa:**

Serigrafia 65x12 mm

-  Ceramica
-  Ø 10,2 x H 3,3 cm
-  12/72

NE



## POSACENERE CERAMICA

BI



**promo**solution



**PORTACHIAVI**

# PORTACHIAVI

## AN 2771 PORTACHIAVI

In legno con anello in metallo.

Max misure stampa: 40x25 mm



-  Legno e Metallo
-  5,3 x 3,8 x 0,8 cm
-  100/500



## AN 2772 PORTACHIAVI

In legno con anello in metallo.

Max misure stampa: 25x20 mm



-  Legno e Metallo
-  4,4 x 0,7 cm
-  100/500



## AN 2773 PORTACHIAVI

In legno con anello in metallo.

Max misure stampa: 35x15 mm



-  Legno e Metallo
-  5,5 x 3,4 x 0,8 cm
-  100/500



## AN 2774 PORTACHIAVI

In legno naturale con anello in metallo.

Max misure stampa: 50x50 mm



-  Legno e metallo
-  10,4 x 4,4 cm circa
-  200/800





**AN 2760  
PORTACHIAVI**

Portachiavi in similpelle e metallo.

**Max misure stampa:** 45x15 mm Similpelle 10 x 3,5 cm 100/500**PORTACHIAVI IN SIMILPELLE E METALLO****AN 2712  
PORTACHIAVI**



Portachiavi rettangolare con placca in metallo colorata e fascetta in poliestere nero. Confezione in astuccio.

**Max misure stampa:** 20x25 mm Metallo 4,1 x 2,5 cm 50/200**PORTACHIAVI  
IN METALLO CON  
FASCETTE IN  
POLIESTERE**

# PORTACHIAVI

## AN 2831 PORTACHIAVI

Con luce e gettone per carrello, in plastica. Confezione in polybag.  
Max misure stampa: 35x15 mm

-  ABS
-  6,3 x 2,9 x 0,5 cm
-  50/500



**CON GETTONE PER CARRELLO**



AR



VE





BL



NE

## AN 2832 PORTACHIAVI

Rettangolare con luce in plastica. Confezione in polybag.  
Max misure stampa: 40x15 mm

-  ABS
-  6,1 x 2,4 x 0,9 cm
-  100/500



**CON LUCE LED**



GI



AR



RO





BL



NE

## AN 2645 PORTACHIAVI 4 FUNZIONI

Apriporta in metallo, funzione portachiavi, punta in gomma touch, gettone per la spesa.  
Max misure stampa: 18x15 mm

-  Metallo
-  6,9 x 2,8 cm  
dim. gettone Ø 2,5 cm
-  50/200

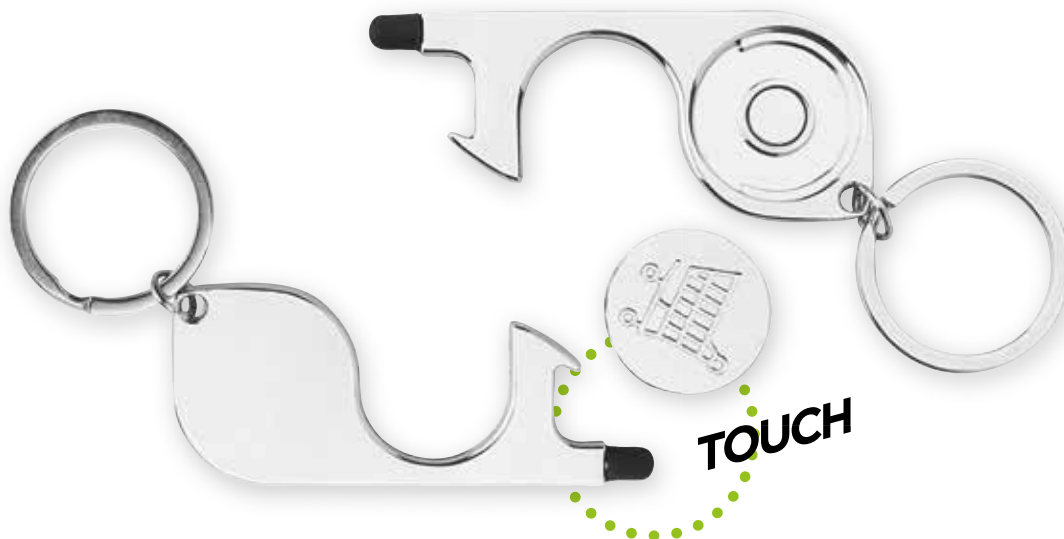

**TOUCH**

**AL 2250  
BERLINO**

Mini penna a sfera touch con portachiaavi in plastica refill nero.  
Max misure stampa: 30x12 mm



-  Plastica
-  8 cm
-  50/500



**AP 2992  
PORTACHIAVI  
TOUCH**

Portachiaavi capacitivo compatibile su schermi touch, con luce LED bianca, batterie incluse.

Max misure stampa: Ø 20 mm



-  ABS
-  6,1 x 8,1 x 1,2 cm
-  100/500



**AN 2834  
PORTACHIAVI**

in plastica con gettone per carrello con led.

Max misure stampa: 35x15 mm

-  ABS
-  7 x 2,5 cm
-  50/500

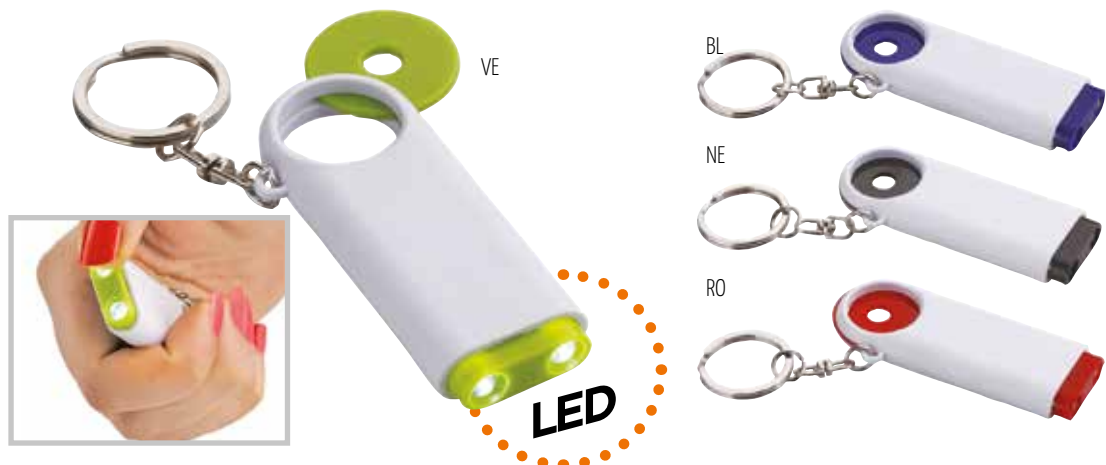

# PORTACHIAVI

## AN 2812 PORTACHIAVI T-SHIRT

In plastica trasparente con incastro etichetta per stampa promo. Fornito aperto.

Max misure stampa: 25x30 mm

-  Plastica
-  7,6 x 0,7 cm
-  100/500



## AN 2813 PORTACHIAVI CERCHIO

in plastica trasparente con incastro etichetta per stampa promo. Fornito aperto.

Max misure stampa: Ø 24 mm



-  Plastica
-  Ø 4,5 x 0,7 cm
-  100/500



## AN 2814 PORTACHIAVI RETTANGOLO

in plastica trasparente con incastro etichetta per stampa promo. Fornito aperto.

Max misure stampa: 20x20 mm

-  Plastica
-  5,9 x 4,1 x 0,6 cm
-  100/500



## AN 2817 REFIL

In carta per portachiaivi, 12 pezzi prefustellati su foglio fto A4

-  Carta
-  A4
-  12



## AN 2815 REFIL

In carta per portachiaivi, 12 pezzi prefustellati su foglio fto A4

-  Carta
-  A4
-  12

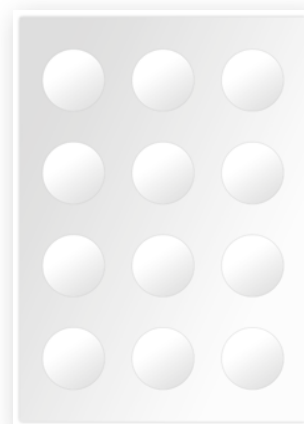

## AN 2816 REFIL

In carta per portachiaivi, 12 pezzi prefustellati su foglio fto A4

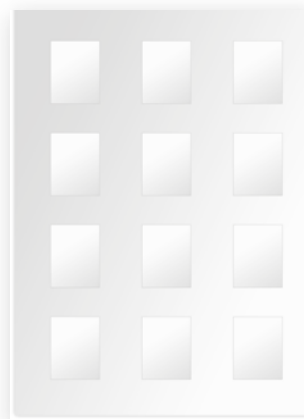

-  Carta
-  A4
-  12



## AN 2841 PORTACHIAVI T-SHIRT

a forma di t-shirt in EVA.

Max misure stampa: 30x25 mm



-  EVA
-  6 x 6,2 x 1,1 cm
-  250/1000



## AN 2842 PORTACHIAVI RETTANGOLO

a forma di rettangolo in EVA.

Max misure stampa: 30x25 mm



-  EVA
-  7 x 4 x 1,1 cm
-  250/1000



## AN 2843 PORTACHIAVI CERCHIO

a forma tonda in EVA.

Max misure stampa: Ø 40 mm



-  EVA
-  Ø 5 x 1,1 cm
-  250/1000



## AN 2844 PORTACHIAVI VELA

a forma di barca a vela in EVA.

Max misure stampa: 30x25 mm



-  EVA
-  7 x 5,5 x 1,1 cm
-  250/1000



# PORTACHIAVI

## PORTACHIAVI VIP

In metallo e caucciù con marchi auto pressofusi.

-  Metallo
-  2 x 2 cm
-  10/50





Retro inciso con laser

 AN 0107	 AN 0119	 AN 0115	 AN 0134	 AN 0132	 AN 0108
 AN 0124	 AN 0133	 AN 0114	 AN 0127	 AN 0123	 AN 0104
 AN 0105	 AN 0125	 AN 0126	 AN 0117	 AN 0118	 AN 0116
 AN 0112	 AN 0111	 AN 0106	 AN 0129	 AN 0113	 AN 0128
 AN 0110	 AN 0109	 AN 0103	 AN 0130	 AN 0120	 AN 0136
 AN 0101	 AN 0102	 AN 0103	 AN 0135	 AN 0121	 AN 0105

## PORTACHIAVI VIP

In metallo con marchi auto pressofusi.

-  Metallo
-  3,5 x 2 cm
-  10/50



AN 0148

Retro inciso con laser

AN 0156



AN 0140



AN 0141



AN 0167



AN 0151



AN 0168



AN 0145



AN 0150



AN 0162



AN 0174



AN 0169



AN 0153



AN 0155



AN 0173



AN 0161



AN 0152



AN 0142



AN 0143



AN 0154



AN 0164



AN 0147



AN 0163



AN 0159



AN 0158



AN 0144



AN 0166



AN 0160



AN 0165



AN 0157



## AN 2648 PORTACHIAVI VIP

Rettangolare in metallo con superficie  
 liscia per incisione laser.

**Max misure stampa:** 25x15 mm

-  Metallo
-  3,5 x 2 cm
-  50/200



## AN 2632 PORTACHIAVI RETTANGOLO

In metallo a forma di rettangolo.  
 Confezione in astuccio.

**Max misure stampa:** 30x40 mm



-  Metallo
-  4,5 x 2,5 cm
-  50/200



## AN 2622 PORTACHIAVI CASA

In metallo a forma di casa.  
 Confezione in astuccio.

**Max misure stampa:** 25x20 mm

-  Metallo
-  7,1 x 4,8 cm
-  50/200



## AN 2640 PORTACHIAVI CERCHIO

In metallo. Confezione in astuccio.  
 **Max misure stampa:** Ø 15 mm

-  Metallo
-  Ø 3,2 cm - Ø interno 2,6 cm
-  50/200



## AN 2623 PORTACHIAVI

Portachiavi camion in metallo  
 rivestito di nickel lucido.

**Max misure stampa:** 45x15 mm

-  Metallo
-  5,4 x 2,8 cm
-  50/200



## AN 2624 PORTACHIAVI AUTO

In metallo a forma di auto.  
 Confezione in astuccio.

**Max misure stampa:** 10x10 mm



-  Metallo
-  6,3 x 4,3 cm
-  50/200





**AN 2868  
PORTACHIAVI  
COAGULATO**

Max misure stampa: 10x10 mm

-  Metallo
-  2,5 x 2 cm
-  50/200





PORTACHIAVI *Tricolore*

**AN 2710  
PORTACHIAVI**

In metallo e tessuto. Confezione in astuccio.

Max misure stampa: 15x20 mm



-  Metallo
-  4 x 2,2 cm
-  50/200



**AN 2602  
PORTACHIAVI  
QUADRIFOGLIO**

In metallo e lacca verde, retro liscio per promo. In astuccio.

Max misure stampa: 10x10 mm

-  Metallo
-  3,5 x 4 cm
-  50/300





# PORTACHIAVI

## AN 2845 LANYARD

Collarino in poliestere con sgancio di sicurezza, sgancio portachiavi e moschettone in metallo.



**Max misure stampa:** 250x15 mm

-  Poliestere
-  55 x 2,5 cm
-  50/500



## AN 2848 PORTABADGE

**Max misure stampa:** 100x70 mm



-  PVC trasparente
-  11,3 x 9,5 cm  
(10x7 int.)
-  10/100



## AN 2852 LANYARD

Lanyard in materiale RPET proveniente da bottiglie riciclate, con moschettone in metallo.

**Max misure stampa:** 230x10 mm

-  RPET
-  50 x 2 cm
-  100/800



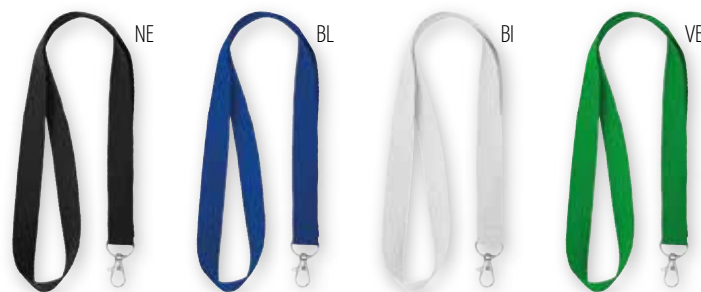

**TESSUTO  
RICAIVATO DA  
RICICLO  
PLASTICA**



## AN 2849 PORTABADGE

**Max misure stampa:** 110x75 mm

-  PVC trasparente
-  8,2 x 13 cm  
(11x7,5 int.)
-  10/100



**promo**solution

**HI-TECH &  
OFFICE**

## AP 2912 CALCOLATRICE

Calcolatrice in bamboo e ABS, visualizza fino a 8 cifre, gioco del labirinto sul retro, incluso pannello solare e batteria LR1131 a 1 cella.

**Max misure stampa:** 35 x 12 mm

 Bamboo/ABS

 12,4 x 6,1 x 1,4 cm

 50/200



## AP 2914 PORTA PENNE

Portapenne in bamboo e plastica da tavolo, con orologio multifunzione con diverse funzioni come l'ora, termometro per interni, calendario (giorno, data, mese), sveglia e ripetizione, timer, promemoria compleanno, batterie incluse.

**Max misure stampa:** 40 x 20 mm

 Bamboo / Metallo / PCB / Plastica

 10,6 x 5,6 x 11,8 cm

 1/50



## AP 2918 STAZIONE METEOROLOGICA

Stazione meteorologica in bamboo, ABS e vetro con supporto pieghevole che si blocca in varie posizioni, diverse funzioni come l'ora, calendario, panoramica della settimana, sveglia, temperatura, umidità ed informazioni meteo, batterie incluse.

**Max misure stampa:** 60 x 25 mm

 ABS / Acciaio Inossidabile / Bamboo / Vetro

 13 x 13 cm

 1/40



**AP 2916  
SUPPORTO PER  
SMARTPHONE**

Supporto per smartphone in bamboo, funzione caricabatterie wireless da 5 W, uscita DC5V/1A, include cavo per la ricarica micro USB - USB.

**Max misure stampa:** 50 x 50 mm

**i** Bamboo / Legno

**7,7 x 7,0 x 12,8 cm**

**25/50**

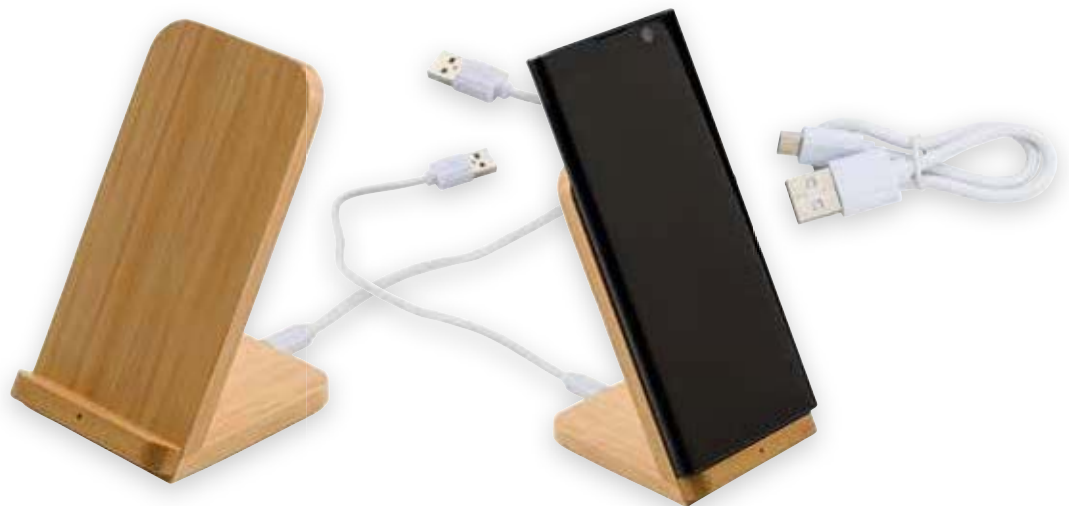

**AP 2920  
SPEAKER WIRELESS**

Speaker wireless in bamboo ed ABS, funzione luci multicolore, potenza 3 watt, batteria ricaricabile Li-on 300 mAh, durata di 3 ore circa, cavo micro USB incluso, confezione regalo bianca.

**Max misure stampa:** 25 x 25 mm

**i** ABS / Bamboo / Legno

**7,2 x 4,4 cm**

**1/50**



**AP 2921  
CARICATORE  
WIRELESS**

Caricatore wireless in bamboo compatibile con smartphone con tecnologia di ricarica wireless. Input 5V/2A e output di 5W. Include cavo USB/micro USB da un metro per la ricarica. Fornito in confezione regalo.

**Max misure stampa:** 70 x 70 mm

**i** Bamboo

**9,2 x 9,2 x 0,9 cm**

**50/100**





## AP 2988 16 GB USB

## AP 2989 8 GB USB

Pendrive Rotate. Maggior protezione grazie al meccanismo girevole. Laccetto e astuccio inclusi.

Max misure stampa: 25x12 mm



-  ABS / Metallo
-  5,8 x 1,8 x 1,0 cm
-  1/50



## AP 2990 16 GB USB

Chiavetta USB 16GB in bamboo girevole. Trattandosi di bamboo naturale possono verificarsi variazioni di colore tra i vari articoli.



Max misure stampa: 27x14 mm

-  Bamboo
-  6,4 x 1,9 x 1 cm
-  1/50



## AP 2993 16 GB USB

Pendrive Portachiavi USB in metallo e pelle con chiusura magnetica.



-  Pelle/ Metallo
-  16 x 10,4 x 3,2 cm
-  1/50



**AP 2994  
8 GB USB**

Card in pvc con Pendrive USB ripiegabile, adatta per stampa UV.

**Max misure stampa:** 85x54 mm

-  PVC
-  8,5 x 5,5 cm
-  1/50





PENDRIVE  
CARD



**AP 2995  
4GB USB**

Pendrive USB a forma di carta di credito in paglia e PP. La superficie piatta del prodotto consente di stampare loghi e immagini in full color.

**Max misure stampa:** 85x54 mm



-  Paglia/PP
-  8,5 x 5,5 x 0,1 cm
-  1/50



**AP 2996  
16 GB USB**

Pendrive USB da 16GB con coperchio protettivo in bamboo.

**Max misure stampa:** 80x45 mm

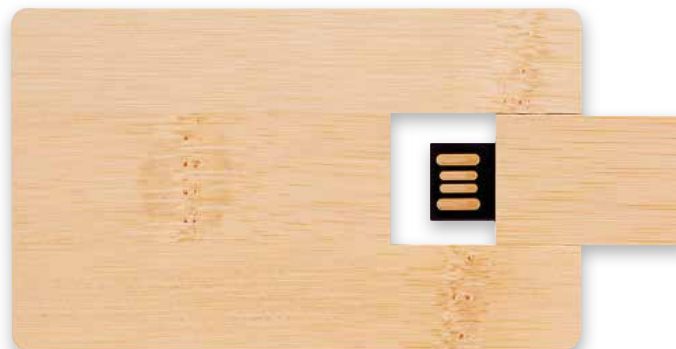

-  Bamboo
-  9 x 5,5 x 0,5 cm
-  1/100



## AP 2945 POWERBANK

Powerbank con capacità 10.000 mAh.  
Confezione regalo.

Max misure stampa: 110x45 mm



-  Plastica
-  14,5 x 6,8 x 2,9 cm
-  1/25



## AP 2946 CAVO DI RICARICA USB

Cavo di ricarica USB 3 in 1, con pannello LED adatto per iPhone e Android.

Max misure stampa: Ø 20 mm

-  Tessile/ Alluminio
-  14,5 x 6,8 x 2,9 cm
-  1/25



## AP 2947 POWERBANK

Powerbank, con capacità 10.000 mAh.  
Confezione regalo.

Max misure stampa: 30x20 mm



-  Plastica
-  8 x 8 x 2,5 cm
-  1/40



## AP 2948 CARICABATTERIE WIRELESS

Ricarica wireless. Confezione regalo.

Max misure stampa: Ø 40 mm



-  Plastica/ Alluminio
-  Ø 6,5 x 0,7 cm
-  1/300





## AP 2949 PORTA TELEFONO



Porta telefono da auto e caricabatteria wireless con magnete. Confezione regalo.  
Max misure stampa: Ø 40 mm

-  Plastica/ Vetro
-  Ø 6 x 1 cm
-  1/60



## AP 2950 CAVO DI RICARICA USB 6 IN 1



adatto per iPhone e Android.  
Max misure stampa: Ø 20 mm

-  Gomma termoplastica
-  100 cm
-  1/50



## AP 2936 CARICABATTERIE PER AUTO

Con ingresso USB, input 12-24V, output 5V/800mAh.  
Max misure stampa: 20x10 mm



-  ABS/ Metallo
-  5,5 x 2,4 cm
-  100/600



## AP 2967 POWERBANK

Adatto per smartphone, iPhone ed apparecchi USB,  
ingresso alimentazione: 5V, potenza in uscita: 5V/  
1000 mA, tempo di ricarica: circa 4 ore, capacità: 2200  
mAh, batteria agli ioni di litio ad alte prestazioni.

Max misure stampa: 55x15 mm



-  Plastica ABS
-  9,8 x 2,4 x 2,1 cm
-  8/80



## AP 2979 POWERBANK

Powerbank con batteria d'emergenza a litio, capacità di 4.000mAh, input 5v/1A, output 5v/1A, indicatore di ricarica, include porta USB, micro USB.

**Max misure stampa:** 70x50 mm



-  Alluminio
-  11 x 6,8 x 1 cm
-  1/25



## AP 2968 POWERBANK

Powerbank adatto per i più comuni smartphone e apparecchi USB, cavo di ricarica USB con micro presa USB (lungo ca. 30 cm), potenza in entrata e uscita: 5V/ 1 A, capacità: 4.000 mAh, potente batteria ricaricabile.

**Max misure stampa:** 60x60 mm



-  ABS
-  9,7 x 4,5 x 2,3 cm
-  1/25



## AP 2977 POWERBANK

Powerbank con una capacità di 5000mAh, un ingresso di 5V/1A e uscita di 1A/2.1A/5V. Entrambi i lati sono lucidi con un bordo color argento. Include 5 luci di indicazione di alimentazione di LED blue e un cavo USB/micro USB bianco (circa 32 cm.), batteria agli ioni di litio ad alte prestazioni.

**Max misure stampa:** 60x35 mm



-  ABS
-  12,2 x 7,2 x 1,1 cm
-  1/25



## AP 2975 POWERBANK

Power bank in ABS da 5000 mAh. Uscita di corrente DC5V/2.1A. Schermo digitale con indice di caricamento. Finitura al tatto gomma con luce LED interno ideale per la stampa laser. Cavo Micro USB incluso. Confezione in astuccio.



**Max misure stampa:** 55x35 mm

-  ABS
-  9,4 x 6,2 x 1,3 cm
-  1/25



### AP 2925 SPEAKER BLUETOOTH

Speaker Bluetooth 3W con soft touch con capacità della batteria di 300 mAh.  
Max misure stampa: 60x40 mm



-  ABS/ Metallo/ Gomma
-  12 x 7 x 3,5 cm
-  1/100



### AP 2924 SPEAKER WIRELESS

Altoparlante bluetooth potenza musicale 3 watt, con versione Bluetooth 4.1, slot per schede micro-SD, incluso cavo di ricarica (da USB a mini-USB e 3,5 mm connettore line-in), riproduce MP3, con funzione vivavoce, batteria ricaricabile integrata con 450 mAh, tempo d'uso: circa 5 ore, tempo di ricarica: circa 2 ore, raggio d'azione circa 10 m, fondo gommato per una presa sicura.

Max misure stampa: 15x15 mm



-  ABS/ Metallo/ Gomma
-  Ø 5,8 x 5 cm
-  1/50



### AP 2906 CASSE SPEAKER

Casse speaker in ABS, forma rotonda, finitura opaca, con cavo per smartphones/tablets.

Max misure stampa: 90x10 mm



-  ABS
-  Ø 7,5 cm - Vol. 0,813 cdm<sup>3</sup>
-  1/50



HUGO BOSS

## AB 0385 AURICOLARI

Auricolari di ultima generazione della collezione Gear Matrix di Hugo BoSs, 6 ore di carica con Case da ricarica 28 ore. Chipset di ultima generazione "ultra clear sound" JL2697. Funzionalità haptic touch per rispondere/interrompere telefonate direttamente dall'auricolare e funzione di start/stop della musica. Ricarica USB-C o ricarica wireless con Qi technology. Funzione di noise cancellation. Doppio microfono per ogni auricolare. Confezionato in scatola regalo Hugo Boss.

-  ABS
-  6,8 x 2,2 x 4,5 cm
-  1





## AURICOLARI WIRELESS BLUETOOTH CON CUSTODIA

## AP 2927 AURICOLARI WIRELESS

Auricolari wireless Bluetooth 5.0 con custodia di ricarica. Elegante finitura bianco lucido. Pannello di controllo con tecnologia touch integrata nell'auricolare. Funzione vivavoce. Custodia con batteria ricaricabile e coperchio magnetizzato. Cavo incluso. Fornito in astuccio.

**Max misure stampa:** 45x30 mm



-  ABS
-  6,8 x 2,2 x 4,5 cm
-  1/50



**AP 2934  
AURICOLARI  
WIRELESS**

Auricolari wireless, funzione di risposta alle chiamate, lunghezza cavo 51 cm circa, ricarica tramite USB, moschettone, in comodo astuccio.

**Max misure stampa:** 50x20 mm



-  ABS
-  10 x 3 x 3 cm
-  10/100



**AP 2931  
AURICOLARI**

Auricolari colorati, lunghezza cavo circa 103 cm, custodia ovale in ABS in tinta colore.

**Max misure stampa:** 50x20 mm



-  ABS
-  7,2 x 2,4 x 1,3 cm
-  10/500



**AP 2929  
AURICOLARI  
IN-EAR MUSIC**

Auricolari con presa da 3,5 mm, cavo lungo ca. 117 cm, in custodia dal colore abbinato.

**Max misure stampa:** 50x50 mm



-  Plastica
-  Ø 5,4 x 2,1 cm
-  10/100



## AP 3000 SUPPORTO PER CELLULARE

Supporto per cellulare multifunzione. Anello girevole a 360°. Moneta trolley integrata. Adesivo.

Max misure stampa: 25x12 mm



-  ABS
-  Ø3,3 x 0,6 cm
-  200/1000



## AP 2992 PORTACHIAVI TOUCH CAPACITIVO

Portachiavi capacitivo compatibile su schermi touch, con luce LED bianca, batterie incluse.

Max misure stampa: Ø 20 mm

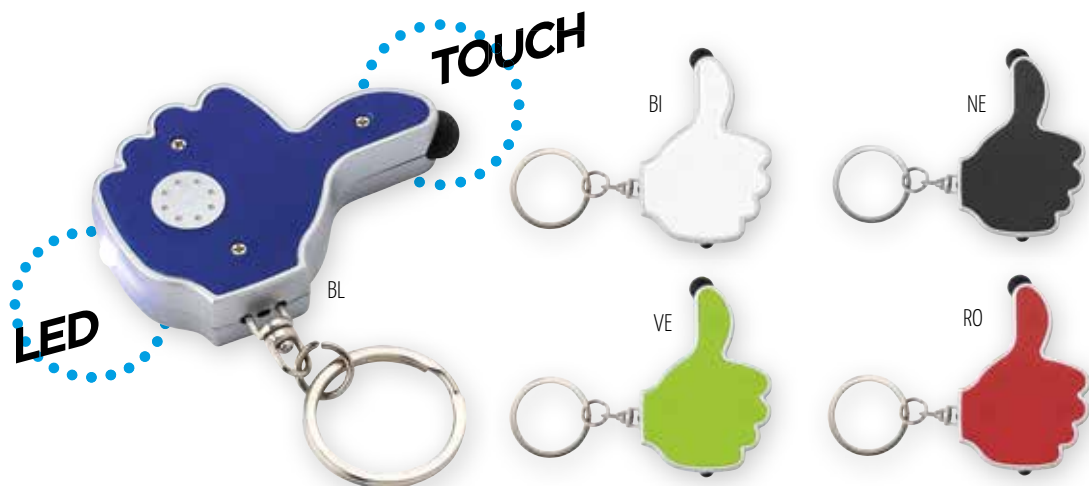

-  ABS
-  6,1 x 8,1 x 1,2 cm
-  100/500



## AN 2895 BRACCIALETTA

Braccialetto in silicone con USB, utilizzabile per la ricarica di vari device in commercio tramite la micro USB, placca in metallo per la personalizzazione.

Max misure stampa: 20x5 mm

-  PVC
-  22 x 1,3 x 0,8 cm
-  1/50



**AP 3044  
TAPPETINO MOUSE**

Tappetino per mouse dal design piatto. Superficie in morbido poliестere e base antiscivolo in silicone. Sublimazione per il colore bianco.

**Max misure stampa:** 220x180 mm

**i** Poliестere/ Silicone

**22 x 18 cm**

**10/200**



TAPPETINO  
MOUSE PER  
SUBLIMAZIONE

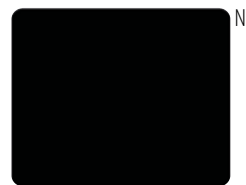

**AP 2917  
RENDIRESTO**

In plastica trasparente, quattro cuscinetti in gommapiuma antiscivolo e un bordo laterale rialzato. È costituito da un vassoio per contanti e da una base inferiore sagomata e si agganciano insieme, sigillando un'etichetta di carta all'interno 200 grammi.

**Max misure stampa:** 154x153 mm

**i** Plastica

**21 x 17 x 1,5 cm**

**30/60**



**AP 3004  
CALCOLATRICE**

Calcolatrice 8 cifre, alimentazione a batteria e solare. Batteria inclusa.

**i** ABS/ LCD/ Vetro

**19,5 x 10,5 x 3,7 cm**

**1/25**





CALCOLATRICE 8 CIFRE



## AL 2370 STILOFORO

Con penna in plastica, cordino a spirale.  
Refil blu.



Max misure stampa: 30x10 mm

-  Plastica
-  16,3x5,4x4 cm
-  20/120



## AP 3053 DISPENSER

Dispenser nastro adesivo. In  
ABS. Scotch incluso. Completa di  
astuccio.

-  ABS
-  13 x 7,1 x 5,4 cm
-  10/40

DISPENSER  
NASTRO  
ADESIVO



## AW 6510 RIGHELLO

in plastica 30 cm.

Max misure stampa: 270x20 mm

-  Plastica
-  31 x 3,6 cm
-  100/200

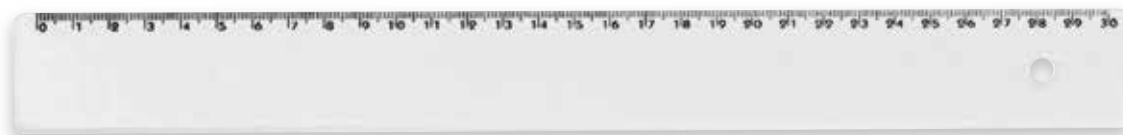

BI

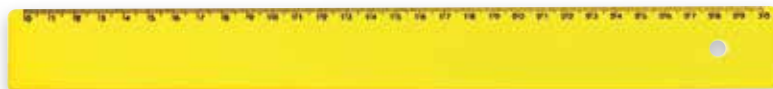

GI



AZ

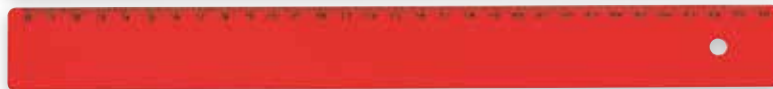

RO





AR



**AP 3070  
PORTAPENNE**

Portapenne da tavolo con orologio, funzione sveglia, calendario e termometro, batterie incluse.

**Max misure stampa:** 45x20 mm

-  ABS/ Acrilico/ LCD
-  5,5 x 10,5 x 12 cm
-  10/40





PORTA PENNE  
CON OROLOGIO  
SVEGLIA  
CALENDARIO  
E TERMOMETRO

**AP 3072  
PORTAPENNE**

Portapenne in plastica bianca con copertura trasparente ad incastro adatta a contenere foglio bianco per la personalizzazione.

**Max misure stampa:** 40x50 mm

-  ABS
-  8,2 x 8,2 x 10,2 cm
-  10/50





PORTA PENNE CON  
PERSONALIZZAZIONE  
AD INCASTRO



**AP 3071  
PORTAPENNE**

Portapenne in plastica bianca.

**Max misure stampa:** 40x50 mm

-  ABS
-  8,2 x 8,2 x 10,2 cm
-  10/50





PORTA PENNE  
IN ABS

## AP 3078 OROLOGIO DA PARETE

Orologio in plastica con numeri in 3D.  
Confezione in astuccio.

Max misure stampa: Ø 213 mm

-  Plastica/Vetro
-  Ø 30,3 x 4,8 cm
-  10





OROLOGIO  
DA PARETE  
CONFEZIONATO  
IN ASTUCCIO

## AP 3076 OROLOGIO DA PARETE

Orologio in plastica con cornice  
facilmente removibile.

Max misure stampa: Ø 213 mm

-  Plastica/Vetro
-  Ø 29x5,5 cm
-  10



OROLOGIO  
DA PARETE  
CON CORNICE  
REMOVIBILE

**AP 3085  
OROLOGIO**

Orologio a muro con meccanismo ad orologeria al quarzo.

**Max misure stampa:** 15x5 mm

 Vetro / Plastica

 Ø 31 x 3,5 cm

 20/80

**AP 3086  
OROLOGIO**

Orologio da muro con cornice e lancette in alluminio, angolo extra ampio previsto per il messaggio pubblicitario.

**Max misure stampa:** 50 mm

 Vetro / Alluminio / Plastica

 Ø 25 x 12,2 cm

 10/20



**AP 3080**  
**OROLOGIO DA**  
**PARETE**

Orologio da parete multifunzione.  
Funzioni di orologio, igrometro e  
termometro.

Max misure stampa: 60x25 mm

 Vetro / Plastica

 27,5 x 32x 2,7 cm

 10

# OROLOGIO DA PARETE

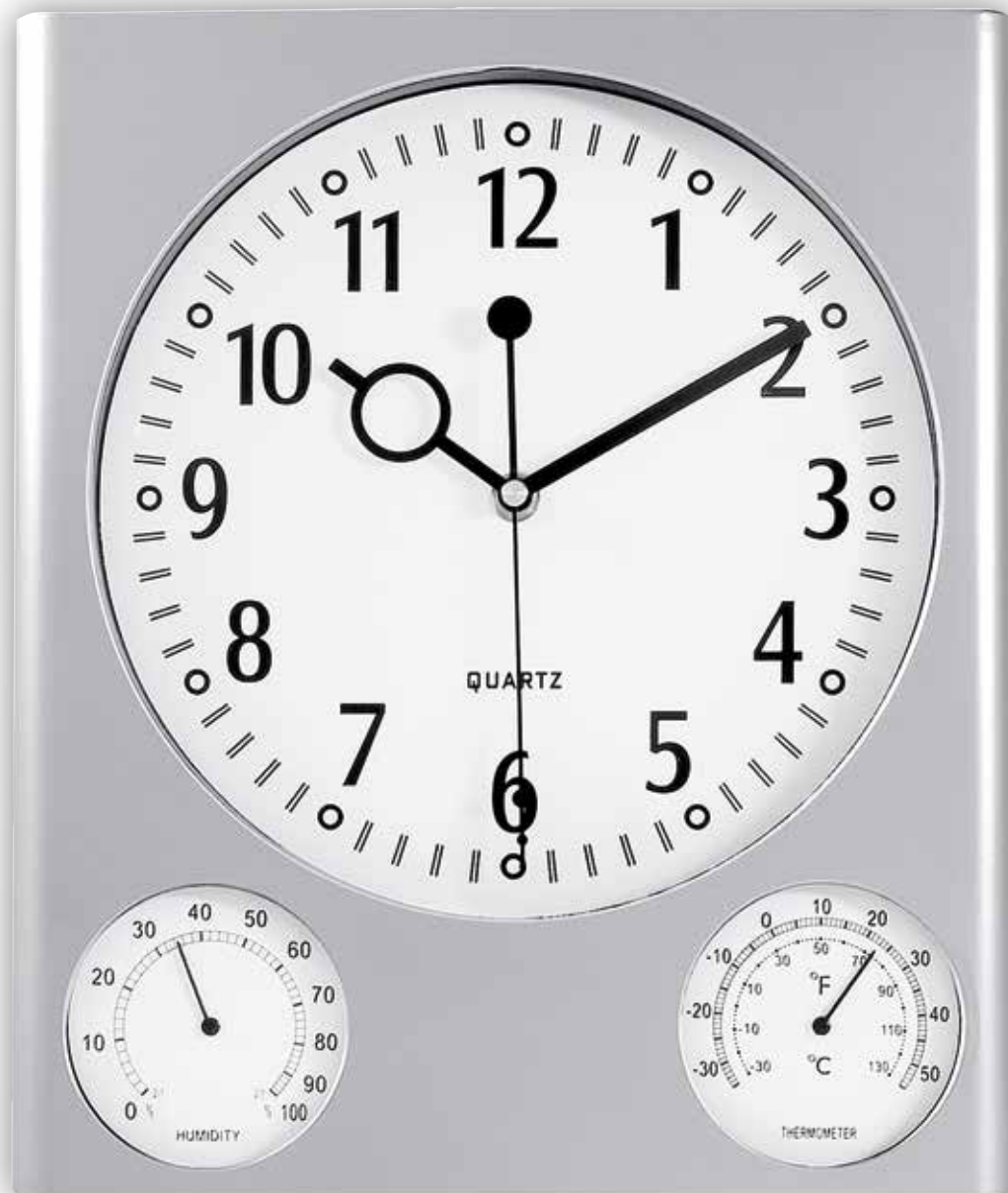

## CON FUNZIONI DI IGROMETRO E TERMOMETRO



**promo**solution

**SHOPPER**

# SHOPPER

## **AQ 4015 SHOPPER IN COTONE RICICLATO 38x41x10**

Borsa da shopping in cotone riciclato  
con soffietto e manici lunghi 68 cm.  
**Max misure stampa:** 300x300 mm

-  Cotone riciclato 140 g/mq
-  38 x 41 x 10 cm
-  30/150

# SHOPPER IN COTONE RICICLATO



**AQ 4014  
SHOPPER  
IN COTONE  
RICICLATO  
37,5x41,5**

Borsa da shopping in cotone riciclato  
con manici lunghi 65 cm.  
Max misure stampa: 300x300 mm

 Cotone riciclato 140 g/mq

 37,5 x 41,5 cm

 50/200



SHOPPER  
IN COTONE  
RICICLATO



# SHOPPER

## **AQ 4031 SHOPPER COTTON 38x42**

Borsa in cotone con  
Manici Lunghi(cm.1,5x60).  
**Max misure stampa:** 300x350 mm

 Cotone - 130 g/mq

 38 x 42 cm

 50/250

## **AQ 4032 SHOPPER COTTON 38x42**

Borsa in cotone con Manici  
Lunghi(cm.1,5x60).  
**Max misure stampa:** 300x350 mm

 Cotone - 180 g/mq

 38 x 42 cm

 40/200

## **AQ 4021 SHOPPER COTTON 38x42**

Borsa in cotone con Manici corti.  
**Max misure stampa:** 300x350 mm

 Cotone - 130 g/mq

 38 x 42 cm

 50/200

# SHOPPER IN COTONE NATURALE





**AQ 4020  
SHOPPER  
COTTON  
38x42**

Borsa da shopping in cotone.  
Manici Lunghi (cm.1,5x60).  
Max misure stampa: 280x280 mm

 Cotone - 135 g/mq

 38 x 42 cm

 50/250

# SHOPPER IN COTONE CON MANICI LUNGHI



# SHOPPER

## AQ 4036 SHOPPER COTTON 38x42x8

Shopper in cotone naturale con soffietto e manici lunghi colorati.

Max misure stampa: 300x350 mm

 Cotone - 180 g/mq

 38 x 42 x 8 cm

 50/200

# SHOPPER IN COTONE

*Con Manici Colorati*



**AQ 4033  
SHOPPER  
COTTON  
38x42**

Shopper in cotone naturale con  
manici lunghi colorati.

**Max misure stampa:** 300x350 mm

**i** Cotone - 135 g/mq

**38 x 42 cm**

**50/200**

SHOPPER  
IN COTONE  
*Con Manici Colorati*

RO





# SHOPPER

## **AQ 4030** **SHOPPER TNT** **45x42x15**

Borsa da shopping con soffietto.  
Max misure stampa: 285x210 mm

 TNT - 80 g/mq

 45 x 42 x 15 cm



 20/200

# SHOPPER IN TNT CON MANICI CORTI



**AQ 4025  
SHOPPER TNT  
38x42x10**

Shopper in tnt con due manici lunghi.  
Max misure stampa: 300x350 mm

-  TNT - 80 g/mq
-  38 x 42 x 10 cm
-  20/200

# SHOPPER IN TNT CON MANICI LUNGH



# SHOPPER

## **AQ 4035 SHOPPER TNT 34x40x20**

Borsa da shopping in Tnt richiudibile  
(20x20 cm). Chiusura con bottone.

**Max misure stampa:** 270x210 mm

**i** TNT - 100 g/mq

**34 x 40 x 20 cm**

**25/100**



## **SHOPPER IN TNT RICHIUDIBILE CON BOTTONE**



**AQ 4026  
SHOPPER TNT  
40x47,5**

Borsa da shopping in Tnt  
richiudibile. Chiusura con bottone.

**Max misure stampa:**

Fronte: 120x120 mm

Retro: 250x250 mm

 TNT - 80 g/mq

 40 x 47,5 cm

 50/150



**SHOPPER IN TNT  
RICHIUDIBILE  
CON BOTTONE**



# SHOPPER

## AQ 4010 SHOPPER TNT 38x42x10

Borsa da shopping bicolore con soffietto.

Materiale: tessuto non tessuto.

Max misure stampa: 250x250 mm

 TNT - 80 g/mq

 38 x 42 x 10 cm

 50/200



## SHOPPER IN TNT

*Bicolore*





**AQ 4043  
MAXI SHOPPER TNT  
RESISTANT 50x38x15**

Effetto striato

**i** TNT - 100g/mq

**o** 50x38x15 cm

**u** 10/100

**AQ 4016  
SHOPPER TNT  
32x25**

Borsa in tnt gofrato con soffiato.

**i** TNT Goffrato - 100 g/mq

**o** 32 x 25 x 25 cm

**u** 10/100



SHOPPER IN TNT  
RESISTANT





# SHOPPER

## AQ 4023 SHOPPER TNT 38X42

Borsa da shopping con manici lunghi.

Max misure stampa: 280x280 mm

 TNT - 80 g/mq

 38 x 42 cm

 20/200





## SHOPPER IN TNT CON MANICI LUNGHI



**AQ 4040  
SHOPPER TNT  
LAMINATO 38x36**

Borsa Shopper in TNT laminato con due manici lunghi.

-  TNT - Laminato
-  38 x 36 cm
-  10/100



SHOPPER IN TNT LAMINATO  
CON MANICI LUNGH

**AQ 4019  
SHOPPER TNT  
21x25**

Shopper in tnt con doppio manico.  
Borsa in tnt goffrato con soffiato.

-  TNT Goffrato - 100 g/mq
-  21 x 25 cm
-  50/300



SHOPPER IN  
TNT GOFFRATO  
CON MANICI CORTI





# SHOPPER

## AQ 4018 SHOPPER TNT 50x40

Borsa in tnt gofrato con soffietto.

 TNT Goffrato - 100 g/mq

 50 x 40 x 22 cm

 12/120



VE



AR





BG



FX

**AQ 4042**  
**SHOPPER TNT**  
**RESISTANT 38x42**

Effetto striato



-  TNT - 100 g/mq
-  38 x 42 cm
-  10/200



BI

**AQ 4012**  
**SHOPPER TNT**  
**45x35**

Borsa in tnt goffrato.

-  TNT - 100 g/mq
-  45 x 35 cm
-  10/300



GR

NE

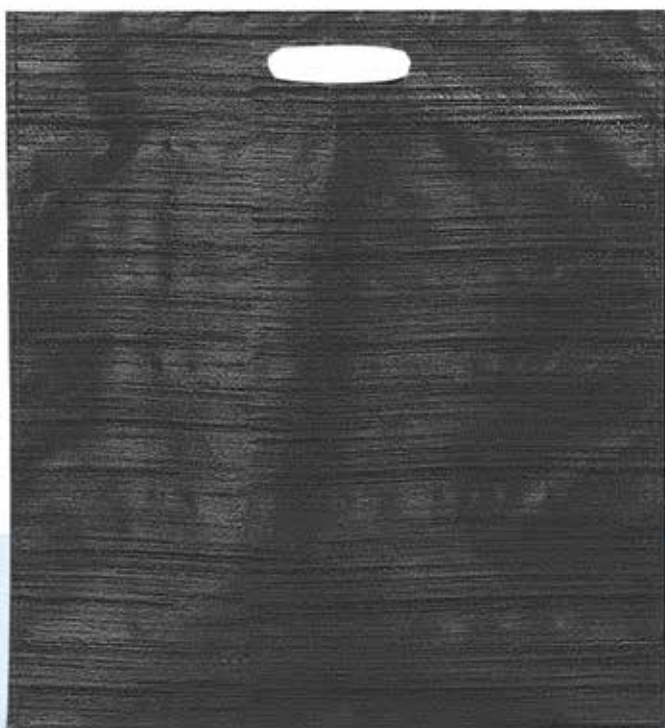

BL





# SHOPPER

## **AQ 4051 SHOPPER IN PPL 45x35x14**

Borsa shopping in polipropilene  
chiusura con zip.

 PPL

 45 x 35 x 14 cm

 10/100



## **AQ 4052 SHOPPER IN PPL 35x25x15**

Borsa shopping in polipropilene  
chiusura con zip.

 PPL

 35 x 25 x 15 cm

 10/100



## AQ 4054 SHOPPER IN PPL 25x18x10

Shopper in tnt con due manici lunghi.

 PPL

 25 x 18 x 10 cm

 10/100



BI

## AQ 4055 SHOPPER IN PPL 52x37x20

Shopper in polipropilene con doppio manico lungo, richiudibile con velcro.

 PPL

 52 x 37 x 20 cm

 20/120



**RICHIUDIBILE  
CON VELCRO**



NE





# SHOPPER

## AR 4060 PORTABICCHIERE

Portabicchiere da degustazione.



**Max misure stampa:** Serigrafia 130 x 100 mm

-  TNT
-  22 x 18 cm
-  50/200



## AR 4061 PORTABOTTIGLIE

Borsa portabottiglia in tnt termosaldata, con soffietto alla base e manici fustellati.



-  TNT
-  17 x 40 x 10 cm
-  100/600

BO



## AR 4062 SHOPPER PORTABOTTIGLIA



in tnt con doppio manico.

-  TNT - 80 g/mq
-  10x33x10 cm
-  100/500



## AQ 4056 BORSA WINE 37x21x10,5

Borsa porta 4 bottiglie in polipropilene.

-  Polipropilene
-  37 x 21 x 10,5 cm
-  10/100

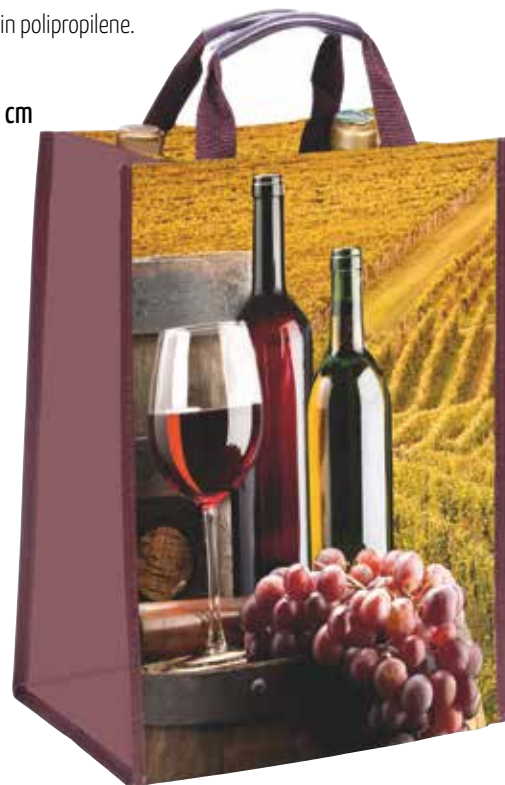





**promo**solution

**WINE&HOME**

## AR 4132 LUNCH BOX

Contenitore cibo con coltello e forchetta  
in paglia di grano biodegradabile.  
Capacità 500 ml.

Max misure stampa: 70x15 mm

-  Paglia di grano
-  16,5 x 11,3 x 4,4 cm
-  10/50





## CONTENITORE CIBO BIODEGRADABILE



## AR 4133 SET 8 CANNUCCE

In cartoncino bianco biodegradabile

-  Cartoncino Biodegradabile
-  25 x 3,2 cm (astuccio)
-  100/500





*biodegradabili*

## AR 4134 SET 3 POSATE

In paglia di grano biodegradabile  
composto da cucchiaio, forchetta e  
coltello in astuccio.



Max misure stampa: 70x30 mm

-  Paglia di grano biodegradabile
-  20 x 6 x 2.5 cm
-  50/200



### AR 4135 CONTENITORE PRANZO



Contenitore pranzo in acciaio inox 304 con coperchio in bamboo e fascia di sicurezza in poliestere. **Capacità 800 ml.** Confezionato in scatola eco design.

-  Acciaio inossidabile 304
-  15,8 x 6,1 x 11,9 cm
-  1/30



### AR 4136 SET POSATE

Set di posate in acciaio inox confezionato in una pratica custodia in neoprene. Include forchetta, coltello e cucchiaio.

-  Acciaio inox e Neoprene
-  21 x 16 cm
-  1/100





### AR 4117 BILANCIA DA CUCINA IN BAMBOO

Bilancia da cucina in bamboo, capacità fino a 5kg.

**Max misure stampa:**

Laser o Serigrafia 60x35 mm

-  Bamboo
-  Ø 18,5 x 1,8 cm
-  40/160



## AR 4120 TAZZA

Tazza bianca con trattamento per  
sublimazione, astuccio incluso.

Capacità 325 ml.

Max misure stampa: 220x85 mm

 Ceramica

 Ø 8,1 x H 9,5 cm

 36/144



## TRATTAMENTO PER SUBLIMAZIONE

## AR 4121 TAZZA

Tazza bianca con bordo e manico  
colorati. Astuccio incluso.

Capacità 300 ml.

Max misure stampa: 220x85 mm

 Ceramica

 Ø 8,2 x H 9,5 cm

 36/144



## AR 4122 TAZZA FLUO

Tazza in ceramica fluorescente personalizzabile in sublimazione o con incisione laser.

Capacità 325 ml.

Max misure stampa: 220x85 mm

 Ceramica

 Ø 8,1 x H 9,5 cm

 36/144



IN CERAMICA FLUORESCENTE  
PER SUBLIMAZIONE O LASER

## AR 4114 TAZZA BIODEGRADABILE

In fibra di grano, leggera.

Capacità 300 ml.

Max misure stampa: 30x30 mm

 Fibra di grano

 Ø 8,4 x 9,5 cm

 36/144



## AY 7745 BICCHIERE

Bicchiere in plastica telescopico, custodia con moschettone.

Capacità 220 ml.

Max misure stampa: Ø 40 mm

 Alluminio / PET

 Ø 18,5 x 1,8 cm

 36/144



## AR 4088 TAGLIAPIZZA

Tagliapizza con apribottiglia in plastica e metallo.

**Max misure stampa:**  
Serigrafia 350x20 mm

-  Polipropilene
-  13 x 6 cm
-  50/200



*con apribottiglia*



## AR 4080 APRIBOTTIGLIE CAVATAPPI

Apribottiglie in metallo.

-  Metallo
-  12,5 x 2 cm
-  50/200





## APRIBOTTIGLIE CAVATAPPI

## AR 4119 COLTELLO DA CAMERIERE IN BAMBOO

Coltello da cameriere, tre funzioni, in bamboo e acciaio inox.

**Max misure stampa:**  
Laser o Tampografia 30x5 mm

-  Bamboo e Acciaio inox
-  11,2 x 2,7 x 1,3 cm
-  40/240



### AR 4077 APRIBOTTIGLIE

Apribottiglie in plastica e acciaio.

**Max misure stampa:**

Tampografia 55x25 mm

 Plastica e Acciaio

 10,2 x 3,5 x 0,4 cm

 50/500

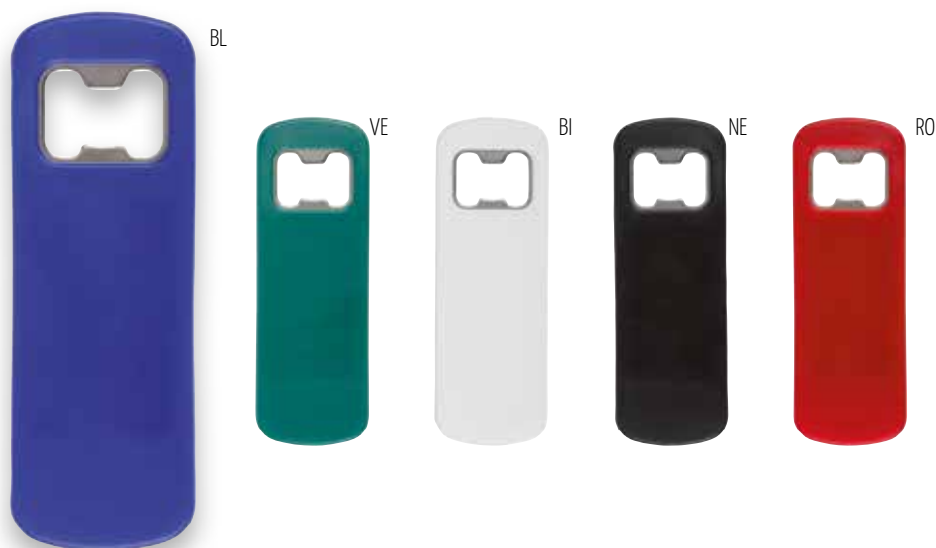

### AR 4070 APRIBOTTIGLIE

Apribottiglie con Fidget Spinner integrato in plastica e metallo.

**Max misure stampa:** Ø 20 mm

 Plastica e Metallo

 8,5 x 3,5 x 1,2 cm

 50/500



### AR 4075 APRIBOTTIGLIE

Apribottiglie con funzione tappo in plastica e metallo.

**Max misure stampa:**

Tampografia 28x33 mm

 Plastica e Metallo

 9,5 x 4 cm

 100/500



## AR 4095 SET VINO

Set vino con 5 accessori in acciaio inossidabile, composti da termometro, anello salvagoccia, beccuccio versatore, tappo e cavatappi, confezione regalo (vino non incluso).

**Max misure stampa:** Serigrafia 200x90 mm

**i** Cassetta in Legno  
Accessori in Acciaio

**36,4 x 11,3 x 11,3 cm**

**1/20**



SET VINO CON  
**5 ACCESSORI**  
**E CASSETTA**  
**IN LEGNO**

## AR 4110 TAGLIERE PER FORMAGGI IN BAMBOO

Tagliere per formaggi in bamboo, incluso tre utensili inseriti nei tagli del tagliere, confezionati singolarmente in scatola di cartone marrone.

**Max misure stampa:** Laser 65x50 mm

**i** Bamboo

**38,0 x 18,5 x 1,7 cm**

**100/300**







### AR 4060 PORTABICCHIERE

Portabicchiere da degustazione.



Max misure stampa: Serigrafia 130x100 mm

-  TNT
-  22 x 18 cm
-  50/500



### AR 4061 PORTABOTTIGLIE



Borsa portabottiglia in tnt termosaldata, con soffietto alla base e manici fustellati.

-  TNT
-  17 x 40 x 10 cm
-  100/500



### AR 4062 SHOPPER PORTABOTTIGLIA



in tnt con doppio manico.

-  TNT - 80 g/mq
-  10x33x10 cm
-  100/500



### AQ 4056 BORSA WINE 37x21x10,5

Borsa porta 4 bottiglie in polipropilene.

-  Polipropilene
-  37 x 21 x 10,5 cm
-  10/100

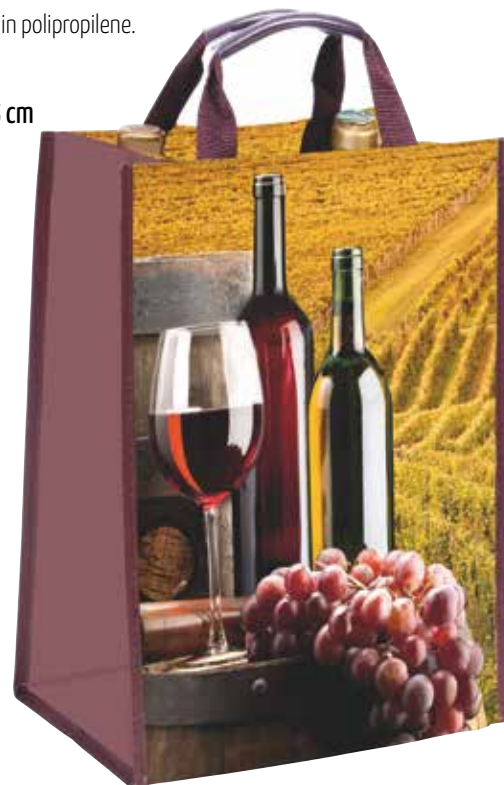

**AY 7342**  
**MARGARITA**

Grembiule unisex con due tasche frontali, cintura in vita e cintura regolabile intorno al collo.

**i** Poliestere 65%  
+ Cotone 35%  
190g/mq

**70 x 90 cm**

**10/50**

# GREMBIULE UNISEX CON DUE TASCHE FRONTALI



### AY 7340 GREMBIULE UOMO

**i** Cotone 65% + Poliestere 35%  
260 g/mq

**1** 100 x 86 cm

**10/50**



BO



NE



### AY 7345 GREMBIULE DONNA

**i** Cotone 65% + Poliestere 35%  
260 g/mq.

**1** 57 x 70 cm

**10/80**



NE



BO

**AY 7347**  
**GREMBIULE UOMO**

Con finto Gilet con 2 tasconi.

**i** Gabardine in Policotone 65% + Poliestere 35% - 180 g/mq

**100 x 86 cm**

**10/50**



GI



BL



RO



VE



BI



NE

GREMBIULI IN STILE GILET

**AY 7350**  
**GREMBIULE DONNA**

Con finto Gilet con 2 tasconi.

**i** Gabardine in Policotone 65% + Poliestere 35% - 180 g/mq

**68 x 87 cm**

**10/50**



BI



NE



GI



BL



VE



RO

**AY 7358  
GREMBIULE  
CON TASCONE**

**i** Cotone pesante 100%  
210 g/mq.

**67 x 84 cm**

**10/80**

**AY 7365  
GREMBIULE BIANCO**

Con tascone.

**i** Cotone pesante 100%  
195 g/mq.

**65 x 80 cm**

**10/100**



**AY 7362**  
**MARTINI**

Grembiule unisex con due tasche sul davanti e cintura.

**i** Poliestere 65% + Cotone 35%  
190g/mq

**85 x 41 cm**

**10/50**

# GREMBIULE UNISEX CON DUE TASCHE FRONTALI



## AY 7360 GREMBIULE BARMAN

Con 3 tasche

**i** Cotone 100% - 210 g/mq

**1** 56 x 36 cm

**2** 10/50



## AY 7341 MOJITO

Grembiule unisex con due tasche sul davanti e cintura.

**i** Poliestere 65% +  
Cotone 35% - 190g/mq

**1** 85 x 61 cm

**2** 10/50





**AY 7359**  
**GREMBIULE**

Con tasca frontale cucita.

Max misure stampa: 140 x 110 mm

 TNT

 73 x 50 cm

 10/50

# GREMBIULE IN TNT CON TASCA FRONTALE





**promo**solution

**BEAUTY**

## AS 5105 SPECCHIETTO

Specchietto da borsa in plastica.  
Max misure stampa: Ø 45 mm

 Plastica / Vetro

 Ø 6 cm

 72/360



## AS 5110 SPECCHIETTO

Specchietto da borsa in plastica  
con ingrandimento.

 Plastica / Vetro

 3,2 x 6,7 cm

 100/300

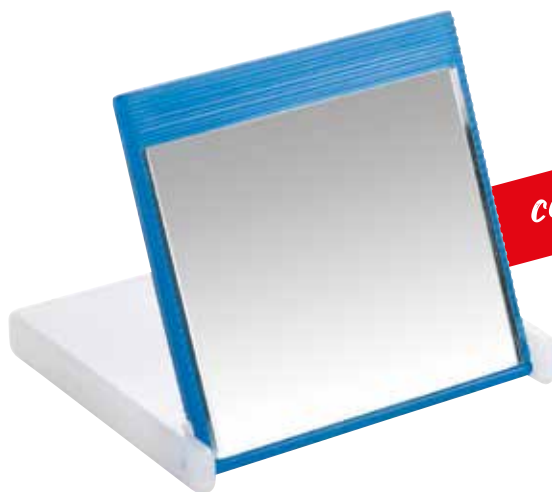

## AS 5066 SET MANICURE

Set manicure cilindrico in ABS e PS, 4  
elementi, comprende le forbici, lima  
per le unghie, tagliaunghie e spingi-  
cuticola.

Max misure stampa:  
Tampografia o digitale 20 x 40 mm

 ABS / PS / Silicone



 50/200



**AS 5095  
SPAZZOLA**



Spazzola richiudibile con specchietto.

Max misure stampa: 55 x 20 mm

-  ABS / Nylon / PVC
-  20,5 x 4,0 x 2,4 cm
-  100/400



**AS 5096  
SPAZZOLA**

Spazzola da viaggio richiudibile con specchio.

-  ABS / Nylon / PVC
-  Ø 6,6 x 2,9 cm
-  48/288

**AS 5092  
PETTINE**

Pettine ripiegabile in plastica.

-  Plastica / Vetro
-  10 x 3,3 cm
-  50/200





## PETTINE REGOLABILE



# BEAUTY

## AS 5035 CRYSTAL BEAUTY

Realizzato in TPU, un materiale morbidissimo e trasparente con finiture in ottone dorato, confezionato con fascia dorata LAVILLE.

-  TPU
-  21 x 10 x 7 cm
-  1/20

## BEAUTY MORBIDO E TRASPARENTE



## AS 5040 SPECCHIETTO

Specchietto in ecopelle con charms e doppio specchietto. Confezione in scatola regalo.



-  Ecopelle
-  Ø 8 cm
-  1/20

## DOPPIO SPECCHIETTO IN ECOPELLE



**AS 5125  
POCHETTE**



Pochette con chiusura a zip in nylon satinato.

-  Nylon
-  17 x 12 x 5 cm
-  10/100

**POCHETTE IN NYLON SATINATO****AS 5120  
POCHETTE**

Pochette con chiusura a zip in pvc satinato.



**Max misure stampa:** 150 x 100 mm

-  PVC
-  25 x 20,7 x 7,2 cm
-  50/150

**POCHETTE CON ZIP**

## AY 7758 VENTAGLIO

Ventaglio in plastica.  
**Misure di stampa:** 60x10 mm

-  ABS
-  23 x 2,2 x 2 cm
-  50/250

## VENTAGLIO IN PLASTICA

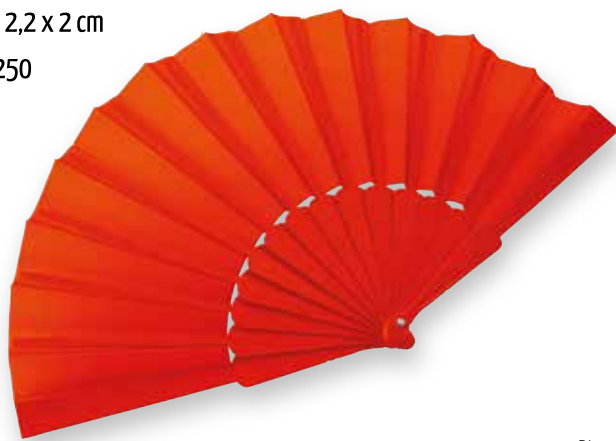

## AS 5116 LIME

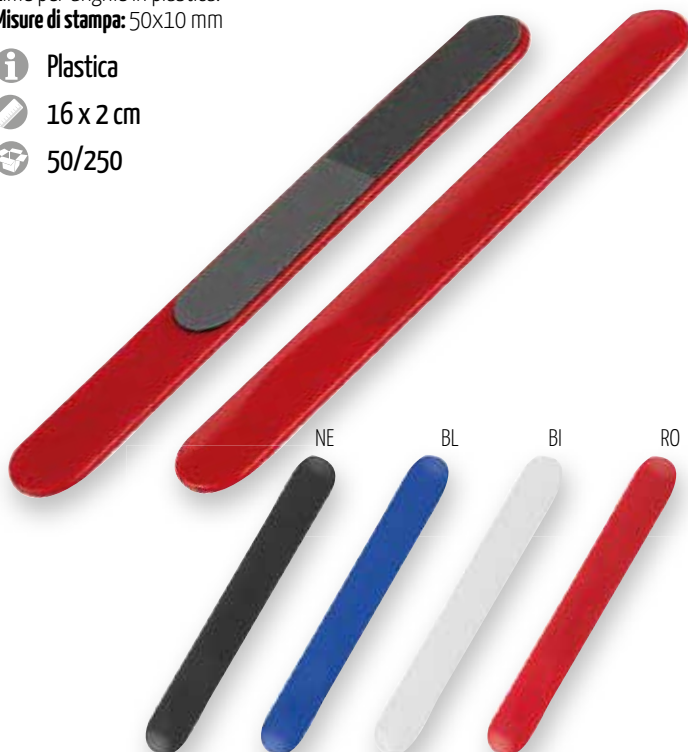

Lime per unghie in plastica.  
**Misure di stampa:** 50x10 mm

-  Plastica
-  16 x 2 cm
-  50/250



## AS 5115 MINILIME

6 mini lime da unghie, nel design "dente di leone", contenute in confezione di cartoncino. **Misure di stampa:** 45x10 mm

-  Carta / EVA
-  5,5 x 6,2 x 0,4 cm
-  100/500

## MINI LIME PER UNGHIE



## AS 5064 PENNA A SFERA

Penna in plastica a forma di rossetto.  
Refil blu. **Misure di stampa:** 27x10 mm

-  Plastica
-  9,8 x 1,8 cm
-  100/500

## PENNA A SFERA



**promo**solution

**OMBRELLI**

# OMBRELLI

## AT 5198 OMBRELLO

Ombrello a scatto automatico in poliestere. Manico curvo e puntale in legno.

Max misure stampa: 280x210 mm

 Poliestere

 Ø 102 x H 89 cm

 12/36

## OMBRELLO AUTOMATICO A SCATTO



**MANICO E  
PUNTALE  
IN LEGNO**





**AT 5214  
OMBRELLO  
AUTOMATICO**

Ombrello con otto pannelli, telaio in metallo, manico in EVA, in poliestere 170 T.

Max misure stampa: 200x100 mm

 Poliestere 170T

 Ø 106 x 82,3 cm

 12/24

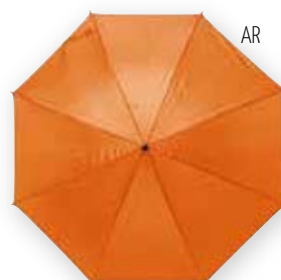
**OMBRELLO IN POLIESTERE  
CON 8 PANNELLI**

## AT 5234 OMBRELLO MAXI GOLF

Ombrello con custodia e tracolla in tinta. Stecca e raggi a doppio spessore in metallo. Manico in gomma morbida.

Max misure stampa: 170x310 mm

 Poliestere 190T

 Ø 125 cm

 12/24

# OMBRELLO MAXI CON CUSTODIA E TRACOLLA



MANICO IN GOMMA MORBIDA





**AT 5232  
OMBRELLO**

Ombrello Automatico con stecca in alluminio, raggi in fibra di vetro e punte in metallo, manico in alluminio-EVA, rivestimento e custodia in poliestere-pongee.

**Max misure stampa:** 160x200 mm

 Poliestere

 Ø 103 cm

 12/36

# OMBRELLO CON RAGGI IN FIBRA DI VETRO



**MANICO E STECCA  
IN ALLUMINIO**

**PUNTE IN  
METALLO**



# OMBRELLI

## AT 5226 MINI OMBRELLO

Mini ombrello con apertura manuale, struttura in metallo, manico in plastica argentata, rivestimento e custodia in poliestere.

**Max misure stampa:** 180x70 mm

 Poliestere

 Ø 98 cm x H 55 cm

 20/40

## MINI OMBRELLO PIEGHEVOLE CON STRUTTURA IN METALLO



RIVESTIMENTO  
E CUSTODIA  
IN POLIESTERE





**AT 5220  
OMBRELLO**

Ombrello pieghevole automatico "Apri & Chiudi" in pongee seta, antivento, otto pannelli, chiusura in velcro, fodera a tema colore, cordino comodo per il trasporto.

**Max misure stampa:** 150x100 mm

 Poliestere

 Ø 97 x 54 cm

 12/36

**MINI OMBRELLO AUTOMATICO  
ANTIVENTO**



**8 PANNELLI CON APERTURA  
E CHIUSURA AUTOMATICA**



**LAVILLE®**  
PARIS

**AT 5256  
OMBRELLO  
PIEGHEVOLE  
CON PORTA  
OMBRELLO**

Un set composto da un mini ombrello 3 sezioni con copertura bicolore e manico gommato al quale è abbinato un simpatico e comodissimo porta ombrello da tavolo. Il tutto confezionato in box regalo LAVILLE.

 Poliestere

 Ø 98 cm

 1/24

# SET OMBRELLO LAVILLE



CONFEZIONATO  
IN BOX REGALO  
LAVILLE



MANICO  
GOMMATO  
E COMODO  
PORTA  
OMBRELLO  
DA TAVOLO



**promo**solution



**TERMOSALDATI**

# TERMOSALDATI

## AU 5950 PORTACARD 12 POSTI

Portacard in PU con 6 bustine interne.  
Chiusura con bottoncino.

Max Misure Stampa: 40x10 mm

-  Poliuretano
-  8 x 10 x 1,5 cm
-  100/300





6 BUSTINE  
INTERNE

## AU 5965 PORTACARD RFID

Portacard slot in alluminio con  
protezione delle card da lettori RFID,  
pulsante espelli carte.

Max Misure Stampa: 50x30 mm

-  Poliuretano
-  9,5 x 6,3 x 0,9 cm
-  50/500



PROTEZIONE DATI DA LETTORI RFID







**AU 5970  
PORTACARD RFID**

Portacard progettato per proteggere la tua carta di credito dalle scansioni di dati bancari dei lettori RFID. Composizione: PE con foglio alluminio interno.

**Max Misure Stampa:** 50x10 mm

 PE + Alluminio

 9 x 6,1 cm

 100/500



PROTEZIONE DATI DA LETTORI RFID





**AU 5982  
PORTACARD**

In PU con retro adesivo.

**Max Misure Stampa:** 35x30 mm

 PU

 6,6 x 9,5 x 0,3 cm

 100/300

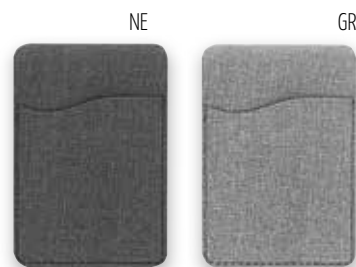

RETRO ADESIVO





**AU 5985  
PORTACARD**

in silicone con retro adesivo.

**Max Misure Stampa:** 35x30 mm

 Silicone



 5,7 x 8,6 x 0,3 cm

 100/300

# TERMOSALDATI

## AU 6000 PORTACARD

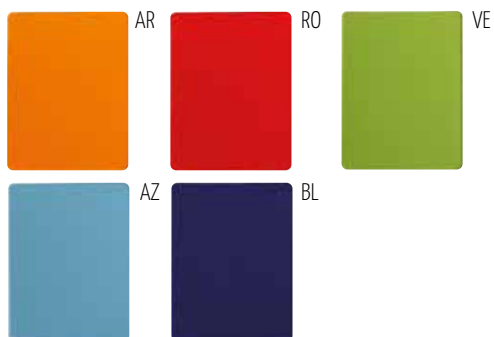

Portacard Singolo realizzato in tam.  
**Max Misure Stampa:** 50x10 mm

-  TAM
-  9 x 6 cm
-  100/300



## AU 6010 PORTACARD

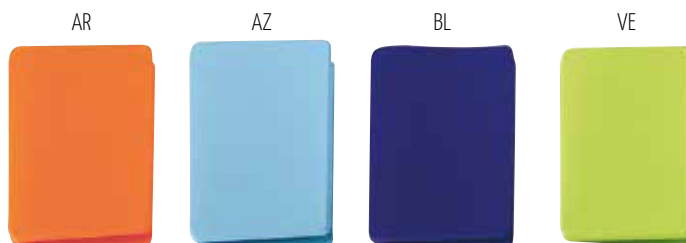
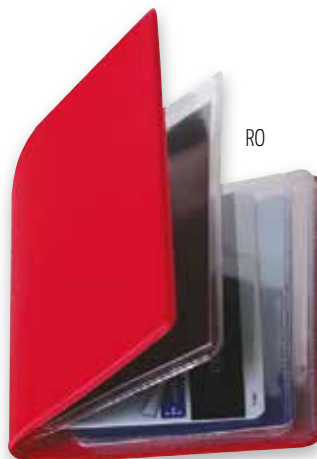

Portacard 4 ante realizzato in tam,  
 contiene 10 card.  
**Max Misure Stampa:** 50x10 mm

-  TAM
-  10 x 7,5 cm
-  100/300



## AU 6005 PORTACARD

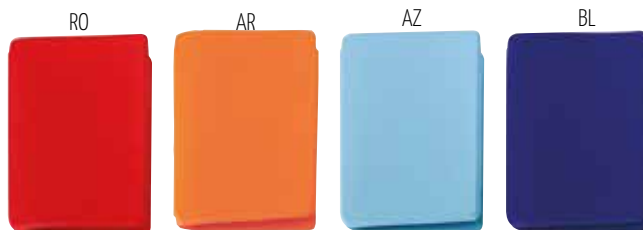

Portacard 2 ante realizzato in tam.  
**Max Misure Stampa:** 50x10 mm

-  TAM
-  9 x 6 cm
-  100/300



## AU 6020 PORTAOGGETTI PORTAMASCHERINA

Bustina portaoggetti portamascherina  
 in pvc.  
**Max Misure Stampa:** 80x80 mm

-  PVC
-  12 x 12 cm (chiuso)
-  100/500

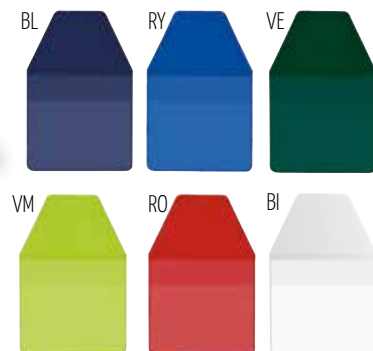



## AU 6038 PORTACARD

Portacard singolo realizzato in PVC elite.

**Max Misure Stampa:** 50x10 mm

 PVC

 9,2 x 6 cm

 100/500



SI



BL



BI

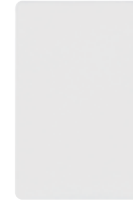

RO





## AU 6041 PORTACARD

Portacard 2 ante realizzato in pvc elite.

**Max Misure Stampa:** 50x10 mm

 PVC

 9,2 x 6 cm (chiuso)

 100/500



SI



BL



BI

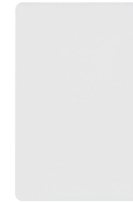

RO





## AU 6039 PORTACARD

Portacard 3 tasche realizzato in pvc elite.

**Max Misure Stampa:** 50x10 mm

 PVC

 9,2 x 6 cm (chiuso)

 100/500



SI



BL



BI

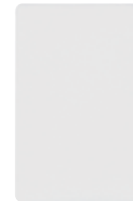

RO





## AU 6033 PORTACARD

Portacard 4 bustine, può contenere 10 card, realizzato in pvc elite.

**Max Misure Stampa:** 50x10 mm

 PVC

 9,4 x 6,7 cm

 100/500



SI



BL



BI

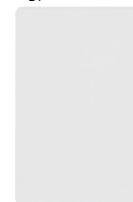

RO





# TERMOSALDATI

## AU 6035 PORTA NOME

Per bagaglio in DEVLON.

Max Misure Stampa: 80x45 mm

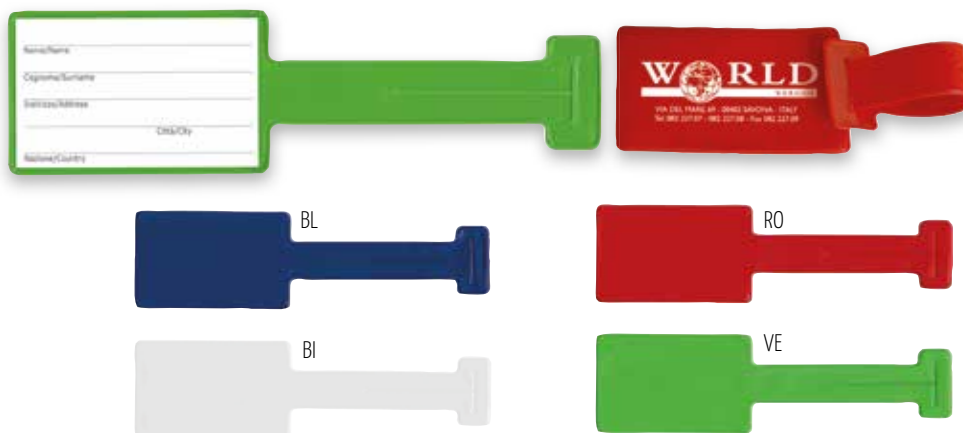

-  DEVLON
-  10 x 6 cm
-  100/500



## AU 6027 PORTA BIGLIETTO AEREO PORTA LOTTO

In pvc con pattina di chiusura.

Max Misure Stampa: 200x110 mm



-  PVC
-  23 x 12,5 (chiuso)
-  100/300



## AU 6030 PORTALOTTO

Portalotto 2 ante in PVC.

Max Misure Stampa: 200x110 mm

-  PVC
-  22,5 x 12 cm (chiuso)
-  100/300





**promo**solution

**AUTO&MOTO**

## AV 6205 PORTADOCUMENTI

Portadocumenti in Tam, con cuciture colorate.

Max Misure Stampa: 50x80mm

-  TAM
-  18,5 x 13 cm
-  100/300





PORTA  
DOCUMENTI  
CON CUCITURE  
COLORATE

## AV 6210 PORTADOCUMENTI

Portadocumenti in Tam, con cuciture colorate.

Max Misure Stampa: 85x35 mm

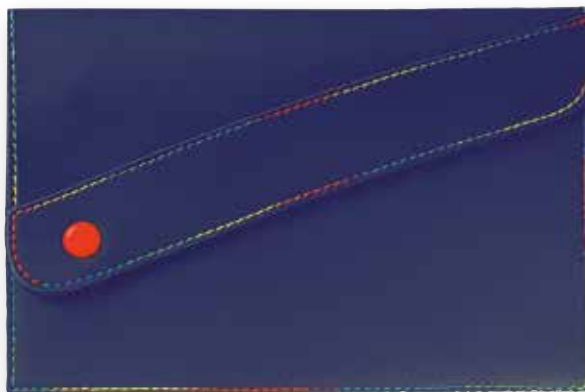

-  TAM
-  20 x 14 cm
-  100/300



## AV 6239 PORTADOCUMENTI

Portadocumenti con fascetta in tam bicolore con bottone.

Max Misure Stampa: 85x35 mm



-  TAM
-  19,5 x 14 cm
-  100/300



**AV 6241  
PORTADOCUMENTI**

Portadocumenti in tam bicolore con bottone.

Max Misure Stampa: 145x40 mm

-  TAM
-  19 x 13 cm
-  50/200



AR



**IN TAM  
BICOLORE**

RO



VM



VE



AZ





BL



**AV 6245  
PORTADOCUMENTI**

Auto chiusura con bottone.

Max Misure Stampa: 145x40 mm

-  Sughero e PU
-  19 x 13 cm
-  100/300



RO

**IN SUGHERO E PU**

GR



AZ





BL



## AV 6243 PORTADOCUMENTI MOTO

Portadocumenti realizzato in TAM con chiusura con pattina.

Max Misure Stampa: 100x55 mm

-  TAM
-  16,5 x 13 cm
-  100/200

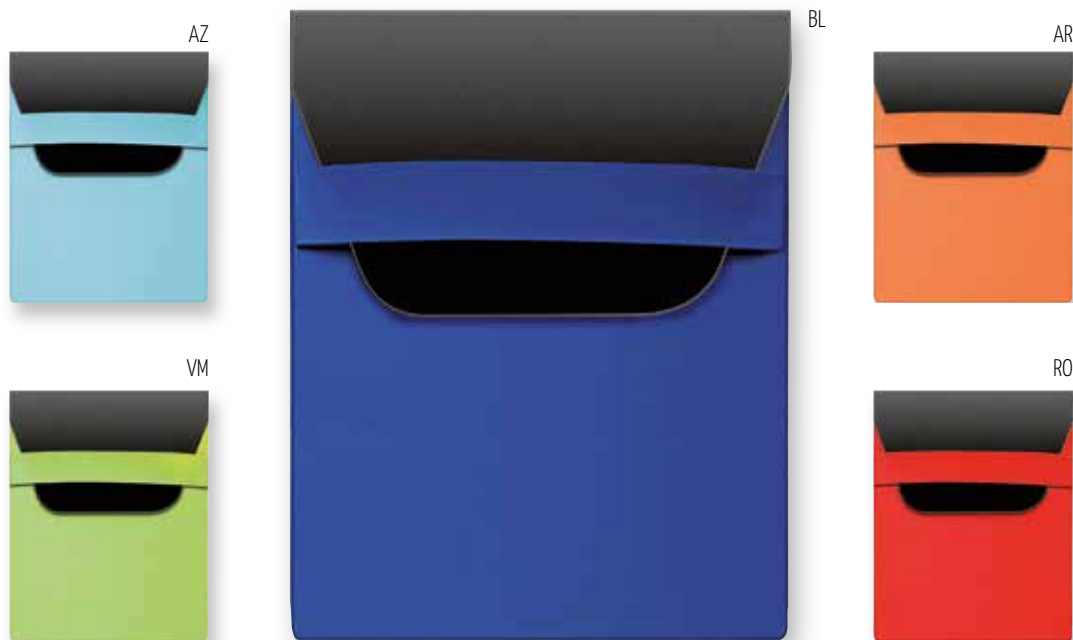



## PORTADOCUMENTI IN TAM BICOLORE

## AV 6240 PORTADOCUMENTI

Portadocumenti realizzato in TAM bicolore, con fascetta.

Max Misure Stampa: 145x35 mm



-  TAM
-  19 x 13 cm
-  50/200





**AU 6042  
PORTADOCUMENTI  
MOTO**



Portadocumenti realizzato in PVC con tasca trasparente.  
**Max Misure Stampa:** 145x95 mm

-  PVC
-  18 x 13 cm
-  100/500



**AU 6055  
PORTAPOLIZZA**



Porta polizza in PVC con tasca trasparente.  
**Max Misure Stampa:** 100x150 mm

-  PVC
-  25,5 x 18,5 cm
-  100/500



**AV 6242  
PORTADOCUMENTI**

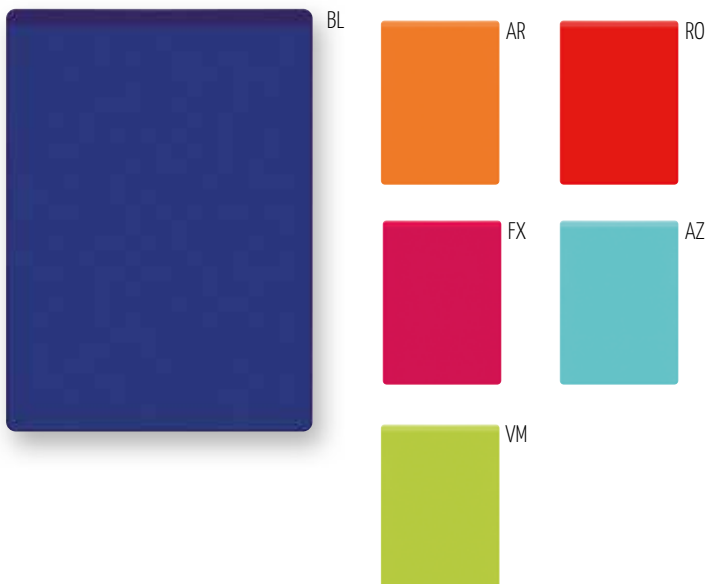

Portadocumenti Realizzato in TAM con tasca trasparente.  
**Max Misure Stampa:** 140x90 mm

-  TAM
-  18 x 13 cm
-  50/500



**AV 6250  
DISCO ORARIO**

Disco orario in PVC.  
**Max Misure Stampa:** 100x15 mm

-  PVC
-  15 x 11,7 cm
-  50/500





## AV 6270 PORTATARGA POSTERIORE AUTO

Portatarga in metallo verniciato nero.

Max Misure Stampa: 490x12 mm

 Metallo

 53,5 x 13,5 cm

 100/300





## AV 6275 PORTATARGA ANTERIORE AUTO

Portatarga in metallo verniciato nero.

Max Misure Stampa: 340x12 mm

 Metallo

 37,5 x 13,5 cm

 100/300





## AV 6292 PORTATARGA POSTERIORE AUTO

In polipropilene fornito con listello in alluminio colore silver

Max Misure Stampa: 480x12 mm

 Polipropilene

 52,5 x 13,5 cm

 100/300



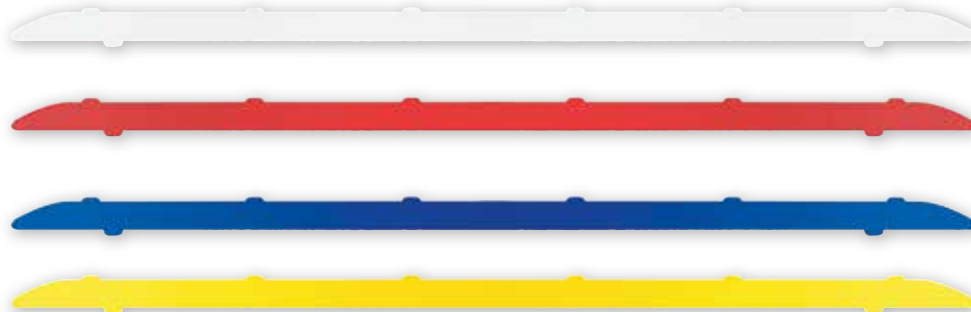

**LISTELLI IN ALLUMINIO FORNITI SU RICHIESTA  
IN ALTERNATIVA AL LISTELLO SILVER.**



**AV 6280  
PORTATARGA  
POSTERIORE AUTO**



Portatarga in metallo verniciato grigio.  
Max Misure Stampa: 490x12 mm

-  Metallo
-  53,5 x 13,5 cm
-  100/300



**AV 6285  
PORTATARGA  
ANTERIORE AUTO**



Portatarga in metallo verniciato grigio.  
Max Misure Stampa: 340x12 mm

-  Metallo
-  37,5 x 13,5 cm
-  100/300



**AV 6260  
PORTATARGA  
POSTERIORE AUTO**



Portatarga in metallo alluminio grigio.  
Max Misure Stampa: 490x12mm

-  Alluminio
-  53,5 x 13,5 cm
-  100/300



**AV 6265  
PORTATARGA  
ANTERIORE AUTO**



Portatarga in metallo alluminio grigio.  
Max Misure Stampa: 340x12 mm

-  Alluminio
-  37,5 x 13,5 cm
-  100/300



## AV 6290 PORTATARGA POSTERIORE AUTO



Portatarga in polipropilene nero.  
Max Misura Stampa: 490x12 mm

-  Polipropilene
-  52,5 x 13 cm
-  50/300



## AV 6295 PORTATARGA POSTERIORE AUTO



Portatarghe in polipropilene argentato.  
Max Misura Stampa: 490x12 mm

-  Polipropilene
-  52,5 x 13 cm
-  50/300



## AV 6339 PORTATARGA PER MOTO

Portatarga in ABS.  
Max Misura Stampa: 150x13 mm

-  ABS
-  18,5 x 20 cm
-  100/300



## AV 6315 PORTATARGA PER MOTO

Portatarga In metallo Grigio.  
Max Misura Stampa: 160x20 mm

-  Metallo
-  19,5 x 23 cm
-  50/300



## AV 6320 PORTATARGA PER MOTO

Portatarga In Metallo Nero.  
Max Misura Stampa: 160x20 mm

-  Metallo
-  19,5 x 23 cm
-  50/300



**promo**solution

**UTILITY**

## AW 6555 FLESSOMETRO

Flessometro a nastro 3 m in ABS con freno e clip in metallo.

Max misure stampa: 20x20 mm

 Plastica e Metallo

 6 x 6 x 3,5 cm

 12/120

## AW 6540 FLESSOMETRO

Flessometro da 3 mt, con blocco del nastro, riavvolgimento automatico impugnatura in gomma.

Max misure stampa: 20x20 mm

 Plastica e Metallo

 6,4 x 6,1 x 3,8 cm

 20/120

## AW 6550 FLESSOMETRO

Flessometro da 5 mt, con blocco del nastro, riavvolgimento automatico impugnatura in gomma.

Max misure stampa: 20x20

 Plastica e Metallo

 7,4 x 6,9 x 2,8 cm

 20/80

## AW 6565 ROTELLA METRICA

Rotella metrica 20 mt. in plastica gialla e nera.

 Plastica

 L. 20 mt

 10/30

## PULSANTE STOP E CLIP DA CINTURA

3 mt



3 mt



5 mt





20 mt



**AW 6515  
DOPPIO METRO  
IN ABS**



Max misure stampa: 72x25 mm

-  ABS
-  L. 2 mt
-  20/200



**AW 6520  
MATITA  
FALEGNAME**

In legno  
Max misure stampa: 55x7 mm

-  Legno
-  17x1 cm
-  100/500



**AW 6525  
DOPPIO METRO  
IN LEGNO**



Max misure stampa: 130x5 mm

-  Legno
-  2 mt
-  12/120



**AW 6529  
CUTTER**



Cutter rettangolare in plastica.  
Max misure stampa: 40x7 mm

-  Plastica
-  10,2 x 3 x 1 cm
-  60/180



## AW 6584 PORTAPILLOLE

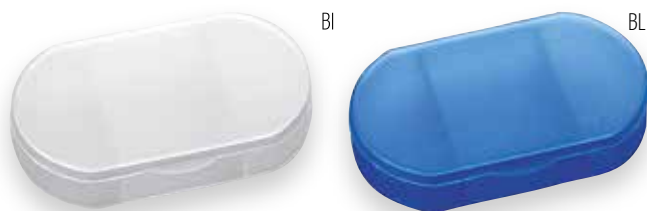

Portapillole in plastica trasparente a 3 scomparti.  
Max misure stampa: 40x20 mm

-  Plastica
-  6 x 3,5 cm
-  100/500



## AW 6587 PORTAPILLOLE



Portapillole in plastica bianca a 3 scomparti.  
Max misure stampa: 40x20 mm

-  Plastica
-  6,5 x 3,5 x 1,5 cm
-  100/500



## AW 6583 PORTAPILLOLE

Portapillole in plastica 4 scomparti.  
Max misure stampa: 40x25 mm

-  Plastica
-  7,9 x 6,3 x 1,6 cm
-  50/250



## AW 6586 TAGLIA PILLOLE

Taglia pillole "Easy Cut" in plastica bianca, dotato, all'interno, di un piccolo coltello che divide la pillola richiudendo la scatola.  
Max misure stampa: 40x20 mm

-  Plastica
-  Ø 7 cm
-  50/300







**AW 6596  
LANYARD**

con flacone spray in plastica,  
contenente alcool al 70%, torcia  
con luce LED.

**Max misure stampa:** 40x8 mm

-  Plastica
-  Ø 1,2x10,8 cm
-  50/200



**AW 6589  
DIFFUSORE SPRAY**

Disinfettante spray tascabile.

**Max misure stampa:** 60x8 mm



-  Plastica
-  1,6 x 14 cm
-  50/250



**AW 6591  
SPAZZOLINO**

Spazzolino da viaggio.

**Max misure stampa:** 55x12 mm

-  Plastica
-  10,3 x 2,4 x 1,5 cm
-  125/250



**AW 6595  
LEVA FUSTELLE**

Levafustelle in plastica e acciaio.

Confezione in polybag.

**Max misure stampa:** 50x6 mm



-  Plastica
-  13 cm
-  100/500



## AW 6599 PORTA ABITI

Pratico portabiti da viaggio, con cerniera, finestra trasparente e apertura per gruccia

Max misure stampa: 150x100 mm



-  TNT
-  60 x 100 cm
-  10/60



## AW 6602 BORSA PORTASCARPE

Borsa in TNT 80 g/mq. Chiusura in coulisse.



Max misure stampa: 250x250 mm

-  TNT
-  36 x 42 cm
-  100/300



## AW 6600 CALZASCARPE

in PS con foro per essere appeso.

-  PS
-  15,3 x 3,8 cm
-  100/300



**promo**solution

**ZAINI &  
SPORTBAG**

**AF 1655**  
**ZAINO**  
**PORTACOMPUTER**

Zaino in poliestere con due scomparti con chiusura a doppia zip, scomparto con interno imbottito per tablet e computer portatile 15", scomparto secondario con varie tasche interne, tre tasche esterne frontali con cerniera più due tasche laterali, due spallacci imbottiti e regolabili, in elegante scatola regalo.

**Max misure stampa:** 80x40 mm

 Poliestere - 2,52 kg

 46 x 35 x 18 cm

 1/10

# ZAINO IN POLIESTERE PER TABLET E COMPUTER

**SPALLACCI  
REGOLABILI**



**SCOMPARTI  
IMBOTTITI  
CHIUSURE  
DOPPIA ZIP**



## AF 1664 ZAINO MAGNUM

Zaino in nylon con chiusura a doppia zip, tasca interna imbottita portacomputer, tasca portatablet, varie tasche interne, spallacci rebolabili imbottiti. Tasca laterale con chiusura a zip e tasca antifurto segrata sul retro con cerniera. Porta usb esterna e chiusura TSA integrata. Confezionato in elegante scatola regalo.

**Max misure stampa:** 150x70 mm

 Nylon - 1,66 kg

 47 x 33 x 17 cm

 1/10

## ZAINO IN POLIESTERE PER TABLET E COMPUTER



**CHIUSURA  
TSA**



**PORTA USB  
ESTERNA**



**CHIUSURA  
DOPPIA ZIP**

## SCOMPARTI IMBOTTITI



## AF 1659

### ZAINO ANTIFURTO

Zaino business con uno scomparto principale, scomparto imbottito per laptop 15" e scomparto tablet, connettore USB, tasca segreta con cerniera sul retro.

**Max misure stampa:** 100x50 mm

 Nylon - 1kg

 45 x 35 x 11 cm

 1/4



## ZAINO ANTIFURTO



## TASCA PER COMPUTER 15"



## PORTA USB ESTERNA



**AF 1665**  
**ZAINO**  
**PORTACOMPUTER**

Zaino portacomputer 15 pollici, scomparto principale con vano imbottito per un portatile, tasche interne, vano sulla parte anteriore con chiusura lampo, manico, spallacci regolabili.

**Max misure stampa:** 110x80 mm

**i** Poliestere 600D e PVC  
 0,799 kg

**49 x 33 x 13**

**1/10**

# ZAINO PORTA COMPUTER 15''



**SCOMPARTO  
 PRINCIPALE  
 IMBOTTITO**



## AF 1669 ZAINO PORTACOMPUTER

Zaino in nylon con due scomparti, scomparto principale con interno imbottito per computer portatile, scomparto secondario con varie tasche interne, due tasche esterne frontali con cerniera e due tasche a rete sui lati, due spallacci imbottiti, manico con impugnatura ergonomica.

**Max misure stampa:** 80x40 mm

 Nylon - 0,84 kg

 45 x 30 x 15 cm

 1/10



SCOMPARTO  
PER  
COMPUTER  
IMBOTTITO



TASCHE  
ESTERNE  
A RETE  
E CON ZIP



## ZAINI IN NYLON PORTA COMPUTER

## AF 1658 ZAINO BUSINESS

Zaino con due scomparti, scomparto imbottito per laptop 15", due tasche con cerniera sul davanti e due tasche a rete sui lati.

**Max misure stampa:** 80 x 40 mm

 Nylon - 0,90 kg

 46 x 32 x 18 cm

 1/10



SCOMPARTO  
PER 15"  
IMBOTTITO





## AF 1663 ZAINO MARTIN

Zaino in poliestere con chiusura a doppia zip, tasca interna imbottita portacomputer, varie tasche interne, spallacci regolabili. Doppia tasca esterna con chiusura a zip. Porta usb esterna.

**Max misure stampa:** 100x50 mm

**i** Poliestere - 0,52 kg

**📏** 42 x 34 x 10 cm

**👤** 1/20



## ZAINO IN POLIESTERE



**DOPPIA ZIP  
DI CHIUSURA**



**DOPPIA TASCA  
ESTERNA CON  
CHIUSURA ZIP**



**TASCA INTERNA  
PER COMPUTER  
IMBOTTITA**

## AF 1662 ZAINO BUSINESS

Zaino con due scomparti principali, scomparto imbottito per laptop 15", tasca con cerniera sul davanti, due tasche a rete sui lati, connettore USB.

**Max misure stampa:** 100x50 mm

 Poliestere

 44 x 32 x 14 cm

 1/20



**CONNETTORE  
USB**



**SCOMPARTO  
PER 15"**



## AZ 7025 ZAINO

Zaino con scomparto frontale a cerniera dotato di gancio a moschettone, scomparto principale a cerniera con tasca e all'interno tasca piccola a cerniera come pure uscita per gli auricolari, 2 scomparti a reti sui lati e lacci comprimanti, manico rinforzato, spalline e schienale con comoda imbottitura.

**Max misure stampa:** 80x80 mm

**i** Poliestere 1680D - 0,56 kg

**◉** 48 x 32 x 18 cm

**👤** 1/15

BL



ZAINO IN  
**POLIESTERE**  
DOTATO DI  
MOSCHETTONE





NE

USCITA PER  
AURICOLARI  
2 SCOMPARTI  
LATERALI  
A RETE

## AZ 7024 ZAINO

Zaino sportivo con design ergonomico e facile da personalizzare. Doppi spallacci rinforzati e cinghia speciale per le mani. Schienale imbottito. Tasca anteriore per le scarpe. Una tasca principale con doppio tiretto e una tasca frontale esterna di minore capacità. Cerniere grigie a contrasto. Dettagli neri. Etichetta rimovibile. Resistente all'acqua.

 100% poliestere 900D  
420 g/m<sup>2</sup>.

 65 x 34 x 33 cm

 1/10



RO



SCOMPARTO  
PER SCARPE



## ZAINO SPORTIVO RESISTENTE ALL'ACQUA



NE



RY



BL

**AZ 7021  
ZAINO**

Zaino con tasca frontale con zip e tasca laterale in rete mesh in poliestere 300D. Tracolle salvaspalle regolabili e manico con rinforzo in similpelle.

**Max misure stampa:** 150x90 mm

 Poliestere 300D

 41 x 31 x 14 cm

 25/100



RY



ZAINO IN  
POLIESTERE  
TRACOLLE  
REGOLABILI



VE



NE



BL

## AZ 7033

### ZAINO

Con tasca anteriore a cerniera, scomparto principale, spalline imbottite regolabili.

Max misure stampa: 80x80 mm

 Poliestere 600D - 0,19 kg

 39,5 x 30 x 10 cm

 10/50



VM

## ZAINO IN POLIESTERE

TASCA ANTERIORE CON CERNIERA

SPALLINE IMBOTTITE



**AZ 7028  
ZAINO**

Con scomparto frontale a cerniera con uscita per auricolari, una tasca esterna a cerniera, maniglia, 2 scomparti esterni a rete sui lati, spalline imbottite.

**Max misure stampa:** 80x80 mm

**i** Poliestere 600D - 0,2 kg

**◉** 40 x 28,5 x 17 cm

**◉** 10/50



RO

**ZAINO IN  
POLIESTERE  
CON  
SPALLINE  
IMBOTTITE**



**USCITA PER  
AURICOLARI  
TASCA ESTERNA  
CON CERNIERA  
SCOMPARTI  
LATERALI IN RETE**



RY



BI



NE



VE



GI

## AZ 7023

### ZAINO

Zaino leggero e compatto con spallacci regolabili, tasca frontale con cerniera verticale.

Max misure stampa: 80x80 mm

 Poliestere 600D - 145 gr/mq

 40 x 23 x 12 cm

 10/50



## ZAINO LEGGERO



**TASCA FRONTALE  
CON CERNIERA  
SPALLACCI  
REGOLABILI**







**AZ 7018  
ZAINETTO  
POLIESTERE**

Con doppio cordoncino di chiusura,  
tasca esterna con zip e uscita per  
auricolari, angoli rinforzati.

**Max misure stampa:** 90x50 mm

 Poliestere 210D - 0,05 kg

 35 x 45 cm

 10/50

**ZAINETTO IN POLIESTERE  
TASCA ESTERNA CON ZIP****ANGOLI RINFORZATI  
USCITA PER AURICOLARI**

## AZ 7019 ZAINETTO POLIESTERE

Con doppio cordoncino di chiusura,  
tasca esterna con zip e uscita per  
auricolari, angoli rinforzati.

Max misure stampa: 250x300 mm

 Poliestere 210D - 0,032 kg

 35 x 45 cm

 10/50

## ZAINETTO CON CORDONCINO DI CHIUSURA



## ANGOLI RINFORZATI





**AZ 7031**  
**ZAINETTO TNT**

Con doppio cordoncino di chiusura in tessuto non tessuto.

Max misure stampa: 240x280 mm

 TNT - 80gr/mq

 42 x 36 cm

 20/100

# ZAINETTO TNT CON DOPPIO CORDONCINO DI CHIUSURA





## AZ 7040 ZAINO IN COTONE

Zaino in cotone, 120 g/mq.

Max misure stampa: 200x100 mm

 100% Cotone - 0,09 kg

 38 x 42 cm

 10/50

## ZAINO IN COTONE CON CORDONCINO DI CHIUSURA





**AZ 7015**  
**ZAINO**  
**CAMOUFLAGE**

In poliestere 210D con angoli rinforzati.

Max misure stampa: 260x280 mm

 Poliestere 210D

 44 x 34 cm

 10/50





## ZAINETTI CAMOUFLAGE IN POLIESTERE

**AZ 7016**  
**ZAINO**  
**CAMOUFLAGE**

Richiudibile in poliestere 190T.

 Poliestere 190D

 43 x 29 x 11 cm

 10/50



**RICHIUDIBILE**

## AZ 7115 BORSA SPORTIVA

Borsa in poliestere 600D, con tracolla regolabile, scomparto principale più tasca laterale con cerniere, manici e fondo rinforzati.

**Max misure stampa:** 80x80 mm

 Poliestere 600D - 0,44 kg

 55 x 33 x 28 cm

 1/20



## BORSONE SPORTIVO BICOLORE DOPPIO MANICO



TRACOLLA  
REGOLABILE



## AZ 7113 BORSA SPORTIVA

Borsa in poliestere 600D, con tracolla regolabile, scomparto principale più tasca laterale con cerniere, manici e fondo rinforzati.

**Max misure stampa:** 80x80 mm

 Poliestere 600D - 0,395 kg

 48 x 28 x 22 cm

 1/20



## BORSONE SPORTIVO FONDO E MANICI RINFORZATI



## AZ 7116 BORSONE SPORTIVO

Con ampio scomparto centrale chiusura zip doppio cursore, tasca esterna con zip, vano laterale porta scarpe, doppio manico e tracolla regolabile.

**Max misure stampa:** 250x150 mm

 Poliestere 600D - 0,448 kg

 56 x 30 x 28 cm

 1/30

RO



## BORSONE SPORTIVO IN POLIESTERE

BL



NE



## ZIP DOPPIO CURSORE VANO PORTA SCARPE





## AZ 7125 BORSA SPORTIVA

Borsa sportiva con grande scomparto separato per scarpe, scomparto principale e 2 tasche laterali con cerniera, tasca sul retro, fondo resistente all'acqua, tracolla regolabile e asportabile fornita di parte imbottita.

**Max misure stampa:** 80x80 mm

 Poliestere 600D - 0,72 kg

 60 x 36 x 26 cm

 1/15

## BORSA SPORTIVA FONDO RESISTENTE ALL'ACQUA



## CON GRANDE SCOMPARTO SEPARATO PER SCARPE



## AZ 7120 BORSA SPORTIVA

Borsa sportiva 2 IN 1: ampio scomparto principale con cerniera, tasca frontale con cerniera, 1 tracolla aggiuntiva, 2 tasche laterali con cerniera, maniglie rinforzate per il trasporto, utilizzabile anche come zaino.

**Max misure stampa:** 80x80 mm

**i** Poliestere 300D/600D  
0,48 kg

**55 x 30 x 28 cm**

**1/20**



## BORSA ZAINO 2 IN 1 TASCA FRONTALE TRACOLLA AGGIUNTIVA



**promo**solution

**TEMPO  
LIBERO**

## AY 7727 BORRACCIA THERMOS

Borraccia/thermos a doppia parete in acciaio inox 304 con isolamento sottovuoto in rame per mantenere più a lungo le vostre bevande calde o fredde. **Capacità 550 ml.**

**Max Misure Stampa:** 30x60 mm

 Acciaio inossidabile

 Ø 7,4 x 22,5 cm

 1/30



## AY 7732 BORRACCIA

Borraccia botton push, beccuccio pieghevole, in acciaio inossidabile, tappo in plastica a tema colore.

**Capacità 600 ml.**

**Max Misure Stampa:** 30x60 mm

 Acciaio inossidabile

 Ø 7,5 x 22,5 cm

 35/140





**BORRACCIA  
IN ACCIAIO  
DOPPIA  
PARETE**

**BORRACCIA  
IN ACCIAIO  
BOTTON PUSH**

**AY 7736  
BORRACCIA**

Borraccia in acciaio inossidabile a doppia parete, tappo a vite. **Capacità 500 ml.**  
**Max Misure Stampa:** 30x60 mm

-  Acciaio inossidabile
-  Ø 7 x 25,7 cm
-  40/200



**BORRACCIA IN ACCIAIO  
DOPPIA PARETE**



**AY 7720  
BORRACCIA**

Borraccia in alluminio: tappo in argento con chiusura a rotazione. **Capacità circa 500 ml.**  
**Max Misure Stampa:** 40x70 mm

-  Alluminio
-  Ø 6,5 x 22 cm
-  50/100



RO

**BORRACCIA  
IN ALLUMINIO  
CHIUSURA A ROTAZIONE**





## AY 7730 BORRACCIA

Borraccia waterproof con moschettone, in alluminio. **Capacità 400 ml.**

**Max Misure Stampa:** 25x55 mm

 Alluminio

 Ø 6,5 x 17 cm

 48/240



VE



**BORRACCIA IN ALLUMINIO CON MOSCHETTONE**

## AY 7731 BORRACCIA

Borraccia waterproof con moschettone, in alluminio. **Capacità 750 ml.**

**Max Misure Stampa:** 30x60 mm

 Alluminio

 Ø 7,3 x 25 cm

 60/240



AR



**BORRACCIA IN ALLUMINIO CON WATERPROOF**

**AY 7722  
BORRACCIA**

Borraccia in acciaio inossidabile 304 con finitura opaca. **Capacità 790 ml.** Tappo da abbinare al corpo della bottiglia. Confezione in astuccio di cartoncino.

**Max Misure Stampa:** 30x60 mm

 Acciaio inossidabile

 Ø 7,4 x 25,7 cm

 50/100



GI

NE

BL

VE

RO

FX

AR



**AY 7725  
BORRACCIA**

Borraccia in alluminio con tappo a vite in plastica colorata, anello in silicone.

**Capacità circa 650 ml.**

**Max Misure Stampa:** 25x55 mm

 Alluminio

 Ø 6,5 x 23 cm

 50/100



**BORRACCIA  
IN ALLUMINIO**



RO

BL

TR

VE

AR



## AR 4120 TAZZA

Tazza bianca con trattamento per  
sUBLIMAZIONE, astuccio incluso.

Capacità 325 ml.

Max misure stampa: 220 x 85 mm

 Ceramica

 Ø 8,1 x H 9,5 cm

 36/144



## TRATTAMENTO PER SUBLIMAZIONE

## AR 4121 TAZZA

Tazza bianca con bordo e manico  
colorati. Astuccio incluso.

Capacità 300 ml.

Max misure stampa: 220 x 85 mm

 Ceramica

 Ø 8,2 x H 9,5 cm



 36/144





**AR 4122  
TAZZA FLUO**

Tazza in ceramica fluorescente personalizzabile in sublimazione o con incisione laser. **Capacità 325 ml.**  
**Max misure stampa:** 220 x 85 mm

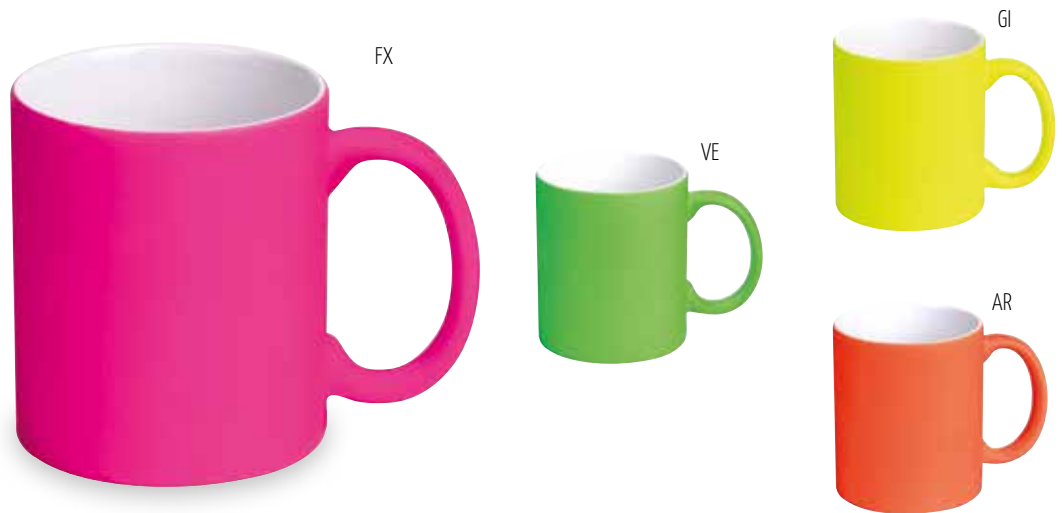

-  Ceramica
-  Ø 8,1 x H 9,5 cm
-  36/144



IN CERAMICA FLUORESCENTE  
PER SUBLIMAZIONE O LASER

**AR 4114  
TAZZA  
BIODEGRADABILE**



in fibra di grano, leggera.  
**Capacità 300 ml.**  
**Max misure stampa:** 30 x 30 mm

-  Fibra di grano
-  Ø 8,4 x 9,5 cm
-  36/144



**AY 7745  
BICCHIERE**

Bicchieri in plastica telescopico, custodia con moschettone.  
**Capacità 220 ml.**  
**Max misure stampa:** Ø 40 mm

-  Alluminio / PET
-  Ø 18,5 x 1,8 cm
-  36/144



## AR 4132 LUNCH BOX

Contenitore cibo con coltello e forchetta  
in paglia di grano biodegradabile.

Capacità 500 ml.

Max misure stampa: 70 x 15 mm

 Paglia di grano

 16,5 x 11,3 x 4,4 cm

 10/50



## CONTENITORE CIBO BIODEGRADABILE



## AR 4133 SET 8 CANNUCCE

In cartoncino bianco biodegradabile

 Cartoncino Biodegradabile

 25x3,2 cm (astuccio)

 100/500



*biodegradabili*

## AR 4134 SET 3 POSATE

In paglia di grano biodegradabile  
composto da cucchiaio, forchetta e  
coltello in astuccio.

Max misure stampa: 70 x 30 mm

 Paglia di grano biodegradabile

 20 x 6 x 2,5 cm

 50/200



BL





BG



VE

**AR 4135  
CONTENITORE  
PRANZO**



Contenitore pranzo in acciaio inox 304 con coperchio in bamboo e fascia di sicurezza in poliestere. **Capacità 800 ml.** Confezionato in scatola eco design.

-  Acciaio inossidabile 304
-  15,8 x 6,1 x 11,9 cm
-  1/30



**AR 4136  
SET POSATE**

Set di posate in acciaio inox confezionato in una pratica custodia in neoprene. Include forchetta, coltello e cucchiaio.



-  Acciaio inox e Neoprene
-  21 x 16 cm
-  1/100



**AR 4117  
BILANCIA DA  
CUCINA IN BAMBOO**

Bilancia da cucina in bamboo, capacità fino a 5kg.

**Max misure stampa:**  
Laser o Serigrafia 60 x 35 mm

-  Bamboo
-  Ø 18,5 x 1,8 cm
-  40/160



## AZ 7077 BORSA TERMICA

Borsa con scomparto principale isolante a cerniera, tasca laterale e tracolla regolabile.

Max misure stampa: 80x80 mm

 Poliestere 420D

 23 x 16 x 26 cm

 1/25





**BORSA  
TERMICA  
CON TRACOLLA  
REGOLABILE**

## AY 7757 COPERTA

Coperta in pile soffice, dotata di custodia con maniglia.

Max misure stampa: 100x40 mm

 Pile - 180 g/mq

 160 x 125 cm

 1/20



**COPERTA  
IN PILE**



**AY 7766  
PORTACELLULARE**

Custodia protettiva impermeabile in PVC, resistente all'acqua per dispositivi mobile, cordino con chiusura di sicurezza lungo circa 46 cm. Grazie allo speciale materiale della custodia è possibile azionare direttamente lo schermo del proprio mobile.

**Max misure stampa:** 60x30 mm

-  PVC
-  26 x 11,1 x 0,1 cm
-  10/500



**CUSTODIA PROTETTIVA IN PVC CHE CONSENTE  
L' ATTIVAZIONE DIRETTA DELLO SCHERMO**



**AN 2896  
BRACCIALETTA**

Braccialetto in Tyvek con chiusura adesiva.

**Max misure stampa:** 60x10 mm

-  Tyvek
-  24,5 x 1,9 cm
-  100/500



Fornito a strisce da 10 pz.

## AY 7751 OCCHIALI DA SOLE

Modello classico, con protezione UV 400

Max misure stampa: 50x7 mm

 PVC/ Policarbonato

 14 x 4,5 cm

 50/250

## OCCHIALI DA SOLE CON PROTEZIONE UV 400



VE



AR



RO



BL



NE



SI



BI



## AY 7758 VENTAGLIO

Ventaglio in plastica.

Misure di stampa: 60x10 mm

 ABS

 23 x 2,2 x 2 cm

 50/250

## VENTAGLIO IN PLASTICA



BI

RO



**promo**solution

**AGENDE**

## AD 1520 AGENDA IN PELLE

Agenda portafoglio in pelle fiore con **interno giornaliero** intercambiabile in carta avorio - **sabato e domenica separati**. Chiusura con linguetta e bottone, tasche interne portacard. Corredata di astuccio.

 Pelle

 17 x 24 cm

 1/10



# AGENDA PORTAFOGLIO IN PELLE



AR

CHIUSURA CON  
BOTTONE  
MAGNETICO



## INTERNO GIORNALIERO INTERCAMBIABILE CON TASCHE



BL



TU

MA





# AGENDA IN PELLE

## AD 1524 AGENDA IN PELLE

Agenda portafoglio in pelle fiore con **interno giornaliero** intercambiabile in carta avorio - **sabato e domenica separati**. Chiusura con linguetta e bottone, tasche interne portacard. Corredata di astuccio

 Pelle

 17 x 24 cm

 1/10



MA



CHIUSURA  
CON  
BOTTONE  
TASCHE  
INTERNE



NE



INTERNO  
REMOVIBILE

## AD 1538 AGENDA PORTAFOGLIO

Agenda portafoglio in coagulato termovirante con **interno giornaliero** intercambiabile con carta avorio - **sabato e domenica separati** - rivestito in vivella. Chiusura con linguetta e bottone, tasche interne portacard. Corredata di astuccio.

 Coagulato termovirante

 17 x 24 cm

 1/10



B0

## AGENDA PORTAFOGLIO IN COAGULATO TERMОВIRANTE



## CARTA AVORIO



BL



**AD 1539  
AGENDA  
BORSELLO**

Agenda portafoglio in coagulato termovirante con **interno giornaliero** intercambiabile con carta avorio - **sabato e domenica separati** - rivestito in vivella. Chiusura con zip, tasche interne portacard. Corredata di astuccio.

 Coagulato termovirante

 17 x 24 cm

 1/20



B0



BL

AGENDA  
BORSELLO  
IN COAGULATO  
TERMОВIRANTE



CONFEZIONE  
IN ASTUCCIO

# AGENDE

## AD 1542 AGENDA PORTAFOGLIO

Agenda portafoglio in coagulato termovirante realizzata con  **fibre vegetali derivate dallo scarto della lavorazione industriale della mela**, con  **interno giornaliero**  intercambiabile in carta riciclata -  **sabato e domenica separati** . Chiusura con linguetta e bottone, tasche interne portacard.

 Coagulato termovirante/  
Carta riciclata

 15 x 21 cm

 1/20



NE



Materiale prodotto utilizzando fibre vegetali derivate dallo scarto della lavorazione industriale della mela.



**BIO  
LINE**



VE



**AD 1543  
AGENDA  
BORSELLO**

Agenda borsello in coagulato termovirante **effetto legno** con **interno giornaliero** intercambiabile in carta avorio - **sabato e domenica separati** - rivestito in vivella. Chiusura con zip, tasche interne portacard. Corredata di astuccio.

 Coagulato termovirante

 17 x 24 cm

 1/20



**AD 1544  
AGENDA  
PORTAFOGLIO**

Agenda borsello in coagulato termovirante **effetto legno** con **interno giornaliero** intercambiabile in carta avorio - **sabato e domenica separati** - rivestito in vivella. Chiusura con linguetta e bottone, tasche interne portacard. Corredata di astuccio.

 Coagulato termovirante

 15 x 21 cm

 1/20



IN COAGULATO  
TERMOVIRANTE  
EFFETTO  
LEGNO



TASCHE  
INTERNE  
PORTACARD

# AGENDE

## AD 1536 AGENDA PORTAFOGLIO

Agenda portafoglio in coagulato termovirante con **interno giornaliero** intercambiabile in carta avorio - **sabato e domenica separati** - rivestito in vivella. Chiusura con linguetta e bottone, tasche interne portacard. Corredata di astuccio.

 Coagulato termovirante

 17 x 24 cm

 1/20



BL

CHIUSURA CON  
LINGUETTA  
E BOTTONE



TO



CONFEZIONE  
IN ASTUCCIO

**AD 1530  
AGENDA  
BORSELLO**

Agenda borsello in coagulato termovirante con **interno giornaliero** intercambiabile in carta avorio - **sabato e domenica separati** - rivestito in vivella. Chiusura con zip, tasche interne portacard. Corredata di astuccio.

 Coagulato termovirante

 17 x 24 cm

 1/20



TO



BL

CHIUSURA  
CON ZIP



TASCHE  
INTERNE  
PORTACARD

# AGENDE

## AD 1537 AGENDA PORTAFOGLIO

Agenda portafoglio con copertina in materiale vivella termovirante, chiusura linguetta e bottone, **interno giornaliero** in carta avorio mobile - **sabato e domenica separati**. Corredata di astuccio.

 Vivella termovirante

 17 x 21 cm

 1/10



## AGENDA IN VIVELLA TERMОВIRANTE



### CONFEZIONE IN ASTUCCIO

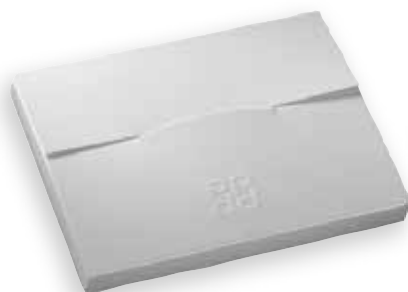



**AD 1531  
AGENDA  
PORTAFOGLIO**

Agenda portafoglio in coagulato termovirante con **interno giornaliero** intercambiabile in carta avorio - **sabato e domenica separati** - rivestito in vivella. Chiusura con linguetta e bottone, tasche interne portacard. Corredata di astuccio.

 Coagulato termovirante

 17 x 24 cm

 1/20



AGENDA PORTAFOGLIO  
CHIUSURA CON BOTTONE  
CARTA AVORIO

**AD 1532  
AGENDA  
PORTAFOGLIO**

Agenda portafoglio in coagulato termovirante con **interno giornaliero** intercambiabile in carta avorio - **sabato e domenica separati** - rivestito in vivella. Chiusura con linguetta e bottone, tasche interne portacard. Corredata di astuccio.

 Coagulato termovirante

 15 x 21 cm

 1/20





## AD 1545 AGENDA BORSELLO

Agenda borsello con copertina in materiale toscana termovirante. Chiusura con zip. **Interno giornaliero mobile in carta avorio - sabato e domenica separati** - da 448 pagine di cui 52 pagine di riepilogo settimanale. Rubrica estraibile. Corredata di astuccio.

 Toscana Termovirante

 17 x 24 cm

 1/30



# AGENDA JAGUAR **BORSELLO**

MA

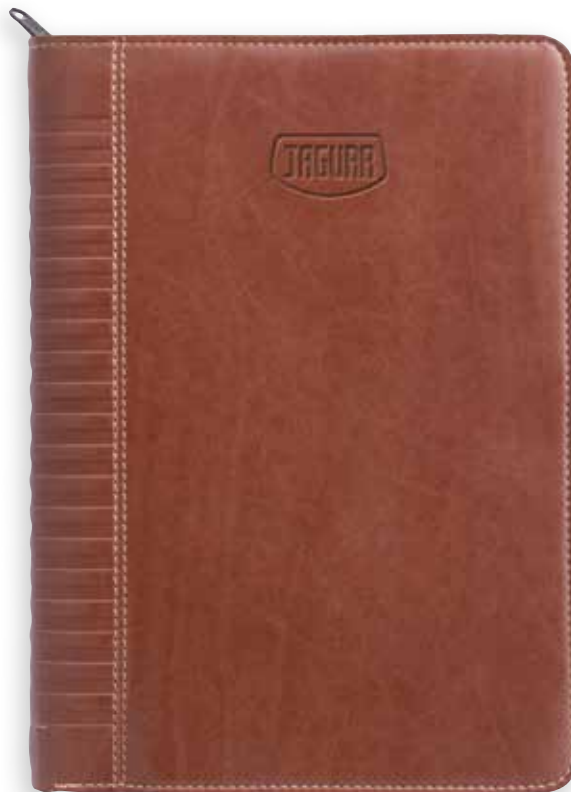

INTERNO  
REMOVIBILE  
SABATO E  
DOMENICA  
SEPARATI



BL

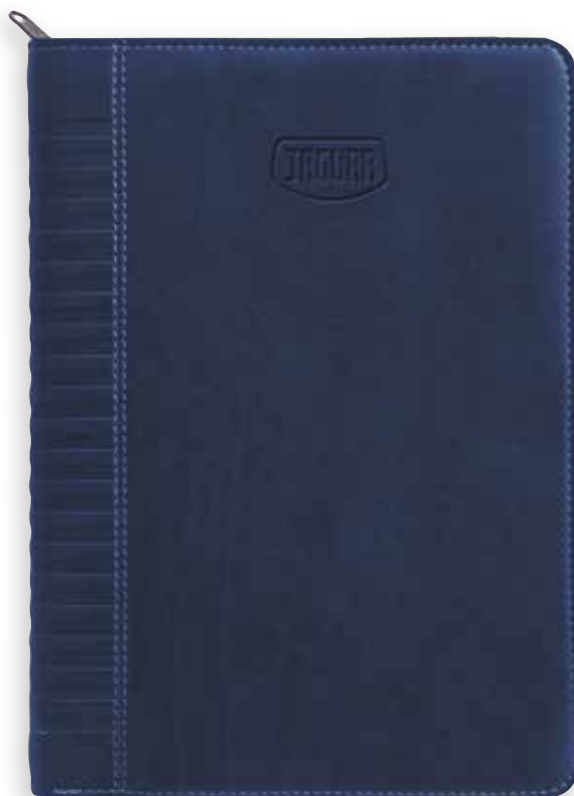

CHIUSURA  
CON ZIP  
CONFEZIONE  
IN ASTUCCIO



**AD 1540  
AGENDA  
GIORNALIERA**

Agenda giornaliera a blocco fisso in bimatrimiale toscana abbinato a vivella termovirante. Interno in carta avorio - **sabato e domenica separati** - da 448 pagine compreso rubrica estraibile e 52 pagine di riepilogo settimanale. Confezione in astuccio.

 Vivella Termovirante

 17 x 24 cm

 26



AGENDA JAGUAR IN **VIVELLA TERMОВIRANTE**

MA



AGENDA  
FLESSIBILE



BL



**SABATO E  
DOMENICA  
SEPARATI  
CONFEZIONE  
IN ASTUCCIO**





## AD 1535 AGENDA GIORNALIERA

Agenda a blocco fisso in vivella termovirante marrone e beige. **Interno giornaliero** in carta avorio - **sabato e domenica separati** - da 448 pagine compresa rubrica fustellata estraibile e 52 pagine di riepilogo settimanale. Corredata di astuccio.

 Vivella termovirante

 17 x 24 cm

 26



## AGENDA JAGUAR IN VIVELLA TERMОВIRANTE

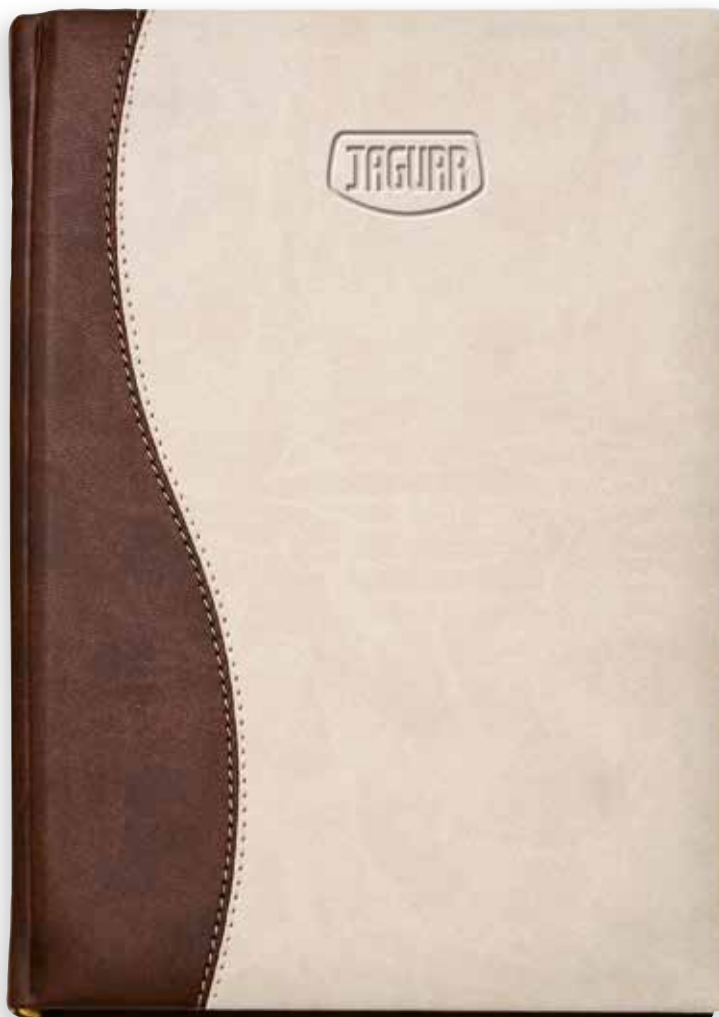

SABATO E  
DOMENICA  
SEPARATI



CONFEZIONE  
IN ASTUCCIO





**AD 1534  
AGENDA  
GIORNALIERA**

Agenda a blocco fisso in vivella termovirante marrone e beige. **Interno giornaliero** in carta avorio - **sabato e domenica separati** - da 448 pagine compresa rubrica fustellata estraibile e 52 pagine di riepilogo settimanale. Corredata di astuccio.

 Vivella termovirante

 17 x 24 cm

 36



AGENDA JAGUAR IN **VIVELLA TERMОВIRANTE**

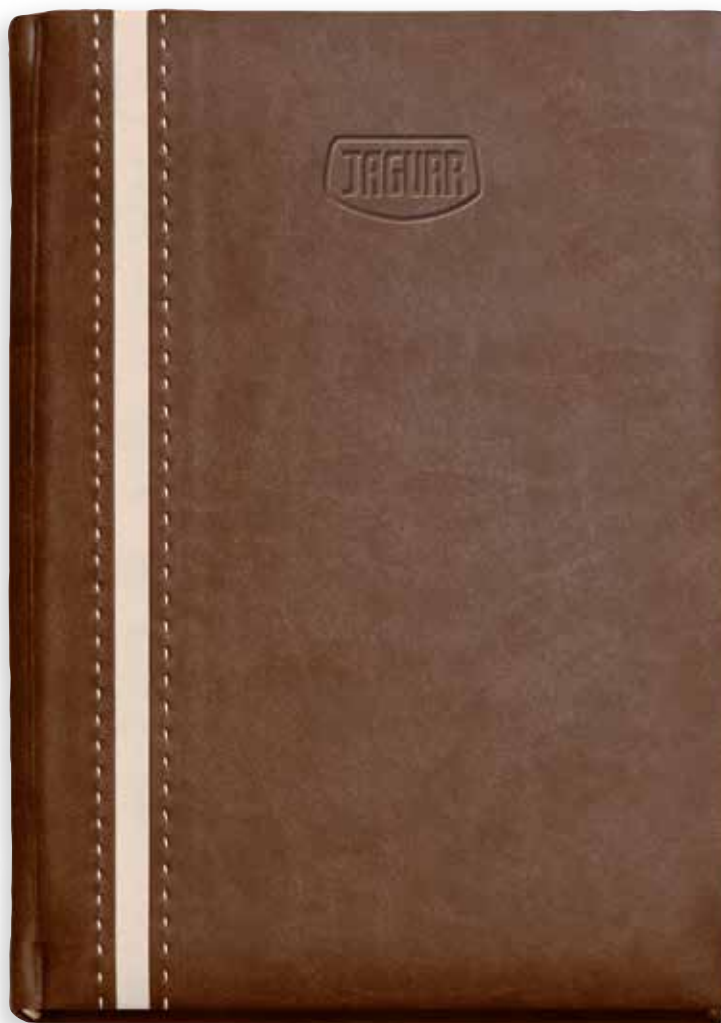

SABATO E  
DOMENICA  
SEPARATI



CONFEZIONE  
IN ASTUCCIO





## AD 1601 AGENDA GIORNALIERA

Agenda portafoglio con copertina in materiale vivella termovirante bicolore, chiusura con linguetta e bottone con taglio portapenna (penna esclusa), **interno giornaliero** mobile in carta bianca - **sabato e domenica separati**. Corredata di astuccio.

 Vivella termovirante

 15 x 21 cm

 60



# AGENDA JAGUAR PORTAFOGLIO



RO



BL

LINGUETTA  
CHIUSURA  
PORTAPENNA



GR



RY



INTERNO REMOVIBILE

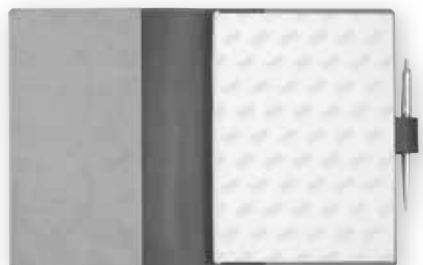



**AD 1605  
AGENDA  
GIORNALIERA  
CON ELASTICO**

Agenda a blocco fisso in bimateriale toscana abbinato a vivella termovirante. Chiusura con elastico. Passante esterno portapenna (penna esclusa), **interno giornaliero** in carta bianca - **sabato e domenica separati**. Corredata di astuccio.

Vivella termovirante

15 x 21 cm

22



# AGENDA JAGUAR PORTAFOGLIO



CHIUSURA  
CON ELASTICO

SABATO E DOMENICA  
SEPARATI A BLOCCO  
FISSO

CONFEZIONE  
IN ASTUCCIO





## AGENDA JAGUAR

### AD 1625 AGENDA GIORNALIERA

Agenda con copertina in vivella adatta per la stampa a caldo. **Interno giornaliero** multilingue in carta bianca da 384 pagine - **sabato e domenica separati**.

 Vivella termovirante

 15 x 21 cm

 22



COPERTINA  
IN VIVELLA  
PER STAMPA  
A CALDO

### AD 1633 ASTUCCIO

Astuccio In Cartoncino

 Cartoncino

 15 x 21 cm







**AD 1625  
AGENDA  
GIORNALIERA**

Agenda con copertina in vivella adatta per la stampa a caldo. **Interno giornaliero** multilingue in carta bianca da 384 pagine - **sabato e domenica separati.**

 Vivella termovirante

 15 x 21 cm

 22



RO



RY



BL



MA



BG



VE

DISPONIBILE IN **6** COLORI



## AD 1590 AGENDA BORSELLO

Agenda borsello in coagulato termovirante, chiusura con zip, tasca interna porta documenti richiudibile con bottone con vari scomparti porta carte di credito. **Interno giornaliero** mobile in carta bianca - **sabato e domenica separati**. Corredata di astuccio.

 Coagulato termovirante

 17 x 24 cm

 1/30



## AD 1592 AGENDA BORSELLO

Agenda borsello in coagulato termovirante, chiusura con zip, tasca interna porta documenti richiudibile con bottone con vari scomparti porta carte di credito. **Interno giornaliero** mobile in carta bianca - **sabato e domenica separati**. Corredata di astuccio.

 Coagulato termovirante

 15 x 21 cm

 1/30



# AGENDA **BORSELLO** 17x24 E 15x21

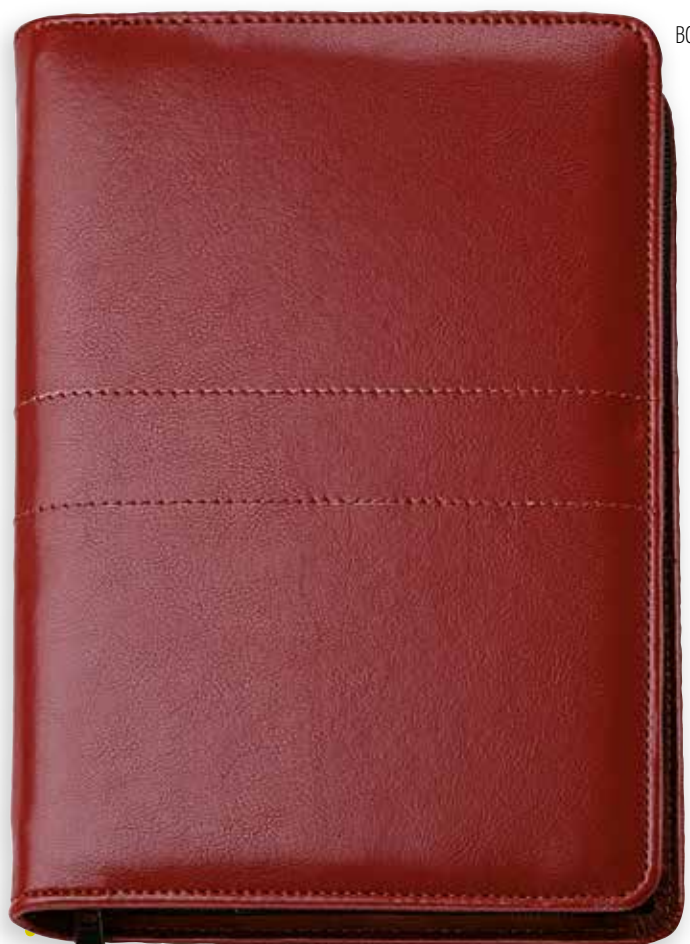

BO

BL



NE



CHIUSURA  
CON ZIP

INTERNO REMOVIBILE GIORNALIERO



**AD 1591**  
**AGENDA BORSELLO**

Agenda borsello in coagulato termovirante. Chiusura con zip, tasche porta documenti interne, portapenna. **Interno giornaliero** estraibile in carta bianca - **sabato e domenica separati**. Corredata di astuccio.

 Coagulato termovirante

 15 x 21 cm

 1/30



# AGENDA BORSELLO

## IN COAGULATO TERMОВIRANTE



CHiusura  
CON ZIP

### AGENDA GIORNALIERA REMOVIBILE

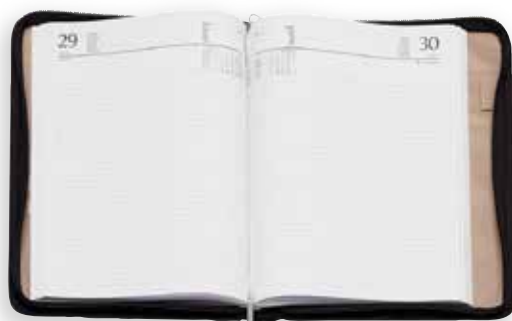

## AD 1551 AGENDA PORTAFOGLIO

Agenda portafoglio in coagulato termovirante, con linguetta di chiusura calamitata, vari scomparti interni portacarte di credito. **Interno giornaliero** mobile in carta bianca - sabato e domenica separati.

 Coagulato termovirante

 17 x 24 cm

 1/30



# AGENDA PORTAFOGLIO



## INTERNO REMOVIBILE GIORNALIERO



**AD 1576  
AGENDA  
PORTAFOGLIO**

Agenda portafoglio con copertina in materiale coagulato termovirante, linguetta di chiusura calamitata. **Interno giornaliero** mobile in carta bianca - **sabato e domenica separati**. Corredata di astuccio.

 **Coagulato Termovirante**

 **15 x 21 cm**

 **1/30**



# AGENDA PORTAFOGLIO



## INTERNO REMOVIBILE GIORNALIERO



## AD 1570 AGENDA GIORNALIERA

Agenda in PU termovirante. Chiusura con elastico, vano esterno portapenne sul dorso. **Interno giornaliero** estraibile in carta avorio - **sabato e domenica separati**. Corredata di astuccio.

 PU termovirante

 17 x 24 cm

 1/30



## AGENDA IN **PU** TERMОВIRANTE

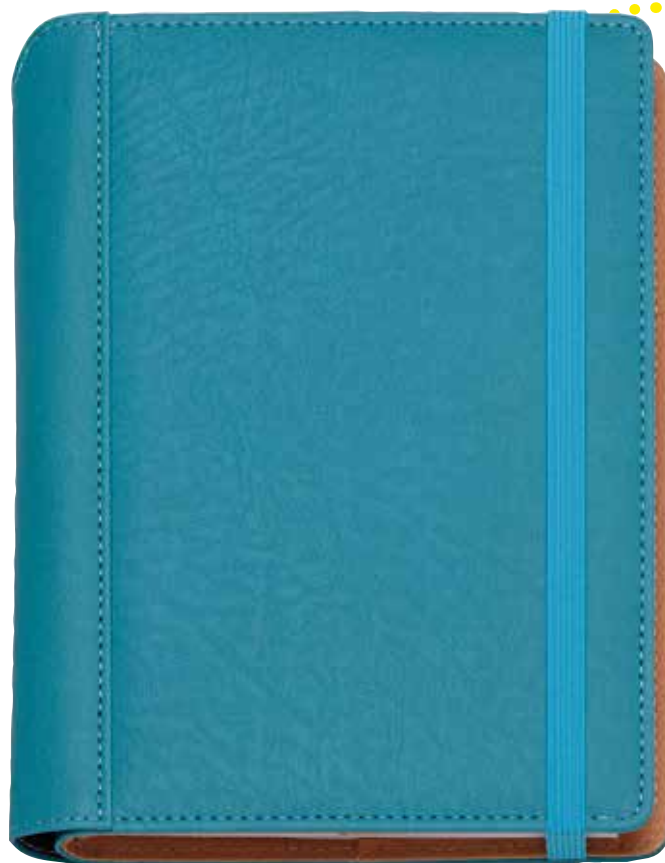

CHIUSURA  
ELASTICO

DORSO  
PORTA  
PENNE



AZ

INTERNO  
ESTRAIBILE

BL

NE



GR

MA

RO

AR

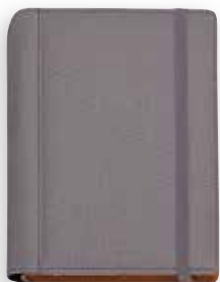

**AD 1583  
AGENDA**

Agenda portafoglio in coagulato termovirante, pattina esterna con chiusura a bottoni e tasca con zip, vari scomparti interni porta carte di credito e porta documenti. **Interno giornaliero mobile** in carta bianca - **sabato e domenica separati**. Corredata di astuccio.

 **Coagulato termovirante**

 **15 x 21 cm**

 **1/30**



AGENDA **PORTAFOGLIO**

AR



GI



**AD 1568  
AGENDA**

Agenda in PU termovirante con pattina anteriore calamitata, porta penna e vari scomparti porta card. **Interno giornaliero mobile** carta avorio - **sabato e domenica separati**. Corredata di astuccio.

 **PU termovirante**

 **18 x 25 cm**

 **1/20**



RO



AZ



# AGENDE

## AD 1582 AGENDA

Agenda in coagulato termovirante con elastico di chiusura dotato di vano portapenna (penna non inclusa). **Interno giornaliero** mobile in carta bianca - **sabato e domenica separati**. Corredata di astuccio.

 Coagulato termovirante

 15 x 21 cm

 1/30



## AGENDA GIORNALIERA CON ELASTICO PORTAPENNE



## AD 1566 AGENDA

Agenda in PU termovirante, chiusura con linguetta e bottone, dotata di porta penna e vari scomparti porta card. **Interno giornaliero** mobile 15x21 in carta bianca - **sabato e domenica separati**.

 PU termovirante

 16 x 21 cm

 1/30





**AD 1580  
AGENDA**

Agenda in PU termovirante. Tasche esterne porta cellulare, portacard, portaoggetti, portapenna. **Interno giornaliero** estraibile 15x21 in carta bianca - **sabato e domenica abbinati**. Corredata di astuccio.

 PU termovirante

 16 x 22 cm

 1/30



# AGENDA IN PU TERMОВIRANTE



**TASCHE ESTERNE  
PER CELLULARE,  
CARD E PENNA**



**INTERNO ESTRAIBILE**



## AD 1608 AGENDA GIORNALIERA

Agenda in tam con interno estraibile  
15x21 giornaliero carta bianca **sabato e  
domenica separati.**

 TAM

 16 x 22 cm

 1/20



# AGENDA GIORNALIERA

VE

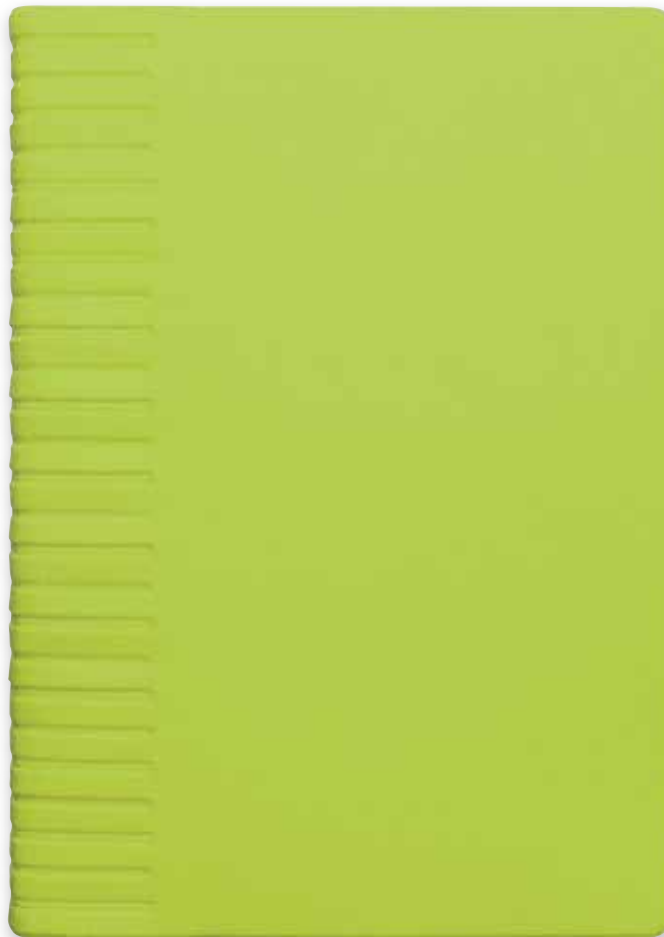

RO



AR

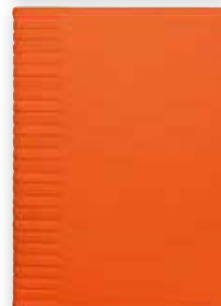

NE



RY





BL



**AD 1615  
AGENDA  
GIORNALIERA  
15X21**

Con copertina in PVC con spirale.  
Interno in carta bianca usomano -  
**sabato e domenica abbinati**, 336 pagine.

-  PVC
-  15 x 21 cm
-  1/20

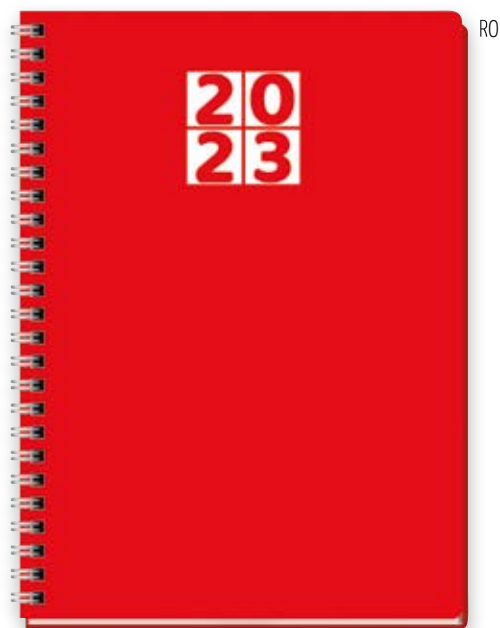

RO



NE





BL



**AD 1618  
PLANNING  
SETTIMANALE  
29,5X16,5**

Con copertina in PVC con spirale  
Interno in carta bianca usomano 120  
pagine.

-  PVC
-  29,5 x 16,5 cm
-  1/50



BL



NE



RO

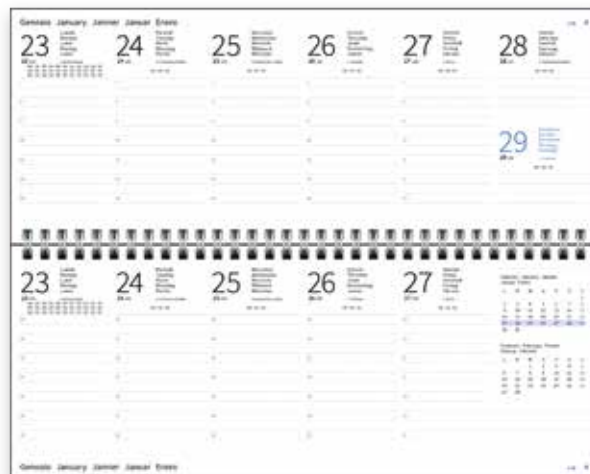

## AD 1627 AGENDA GIORNALIERA 15x21

Copertina in matra, interno multilingue  
da 320 pag. in carta usomano bianca  
60g - sabato e domenica abbinati.

 Matra

 15 x 21 cm ca.

 22



# AGENDA GIORNALIERA 15x21

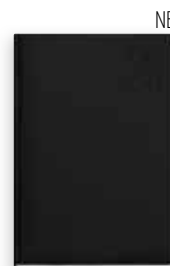
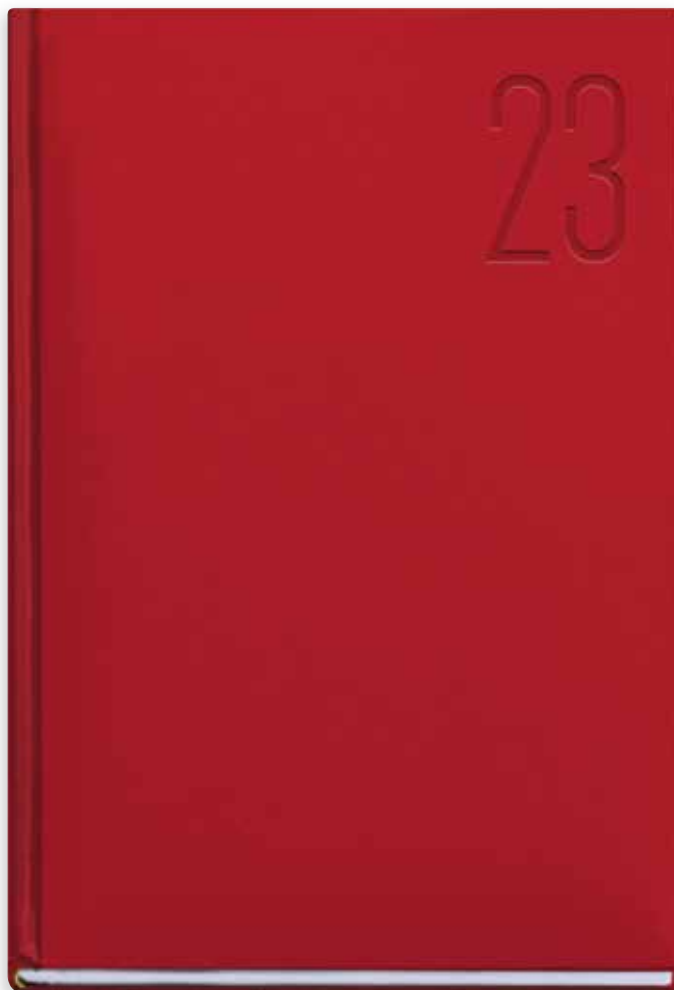

NE



GR



BI



BO



RO



VE





BL



RY

**AD 1624  
AGENDA  
GIORNALIERA  
11X17**

Copertina in matra, interno multilingue da 320 pag. in carta usomano bianca 60g - sabato e domenica abbinati.

-  Matra
-  11 x 17 cm ca.
-  52





# AGENDA GIORNALIERA **11x17**



## AD 1630 AGENDA SETTIMANALE 17x24

Copertina in matra, interno multilingue da  
128 pag. in carta usomano bianca **80g.**

-  Matra
-  17 x 24 cm ca.
-  36



# AGENDA SETTIMANALE **17x24**

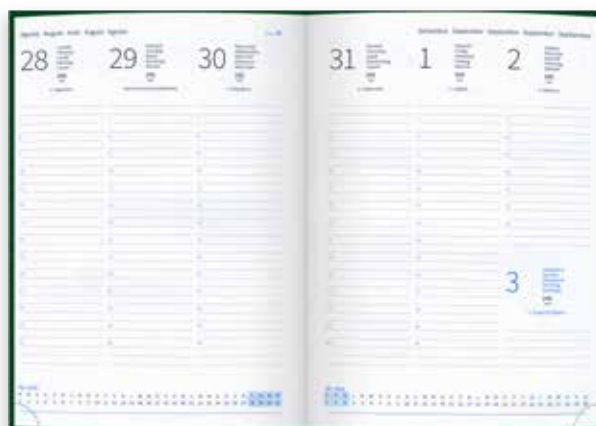
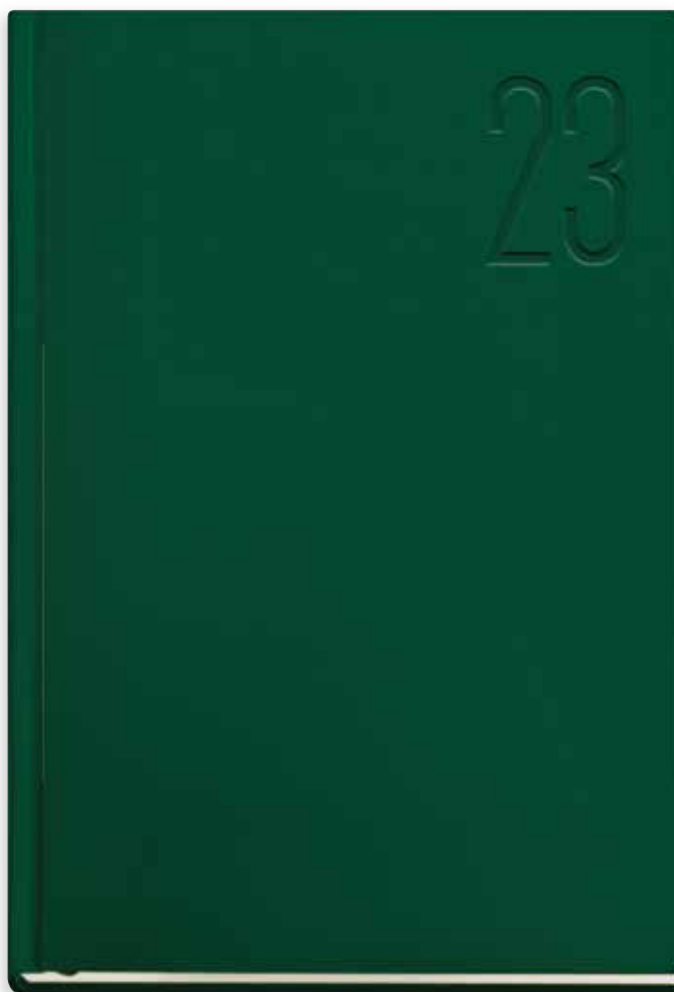

**AD 1620  
AGENDA  
GIORNALIERA  
17x24**

Agenda giornaliera in matra. Interno multilingue, stampa 2 colori, carta bianca **60g - sabato e domenica abbinati.**

 **Matra**

 **17 x 24 cm ca.**

 **26**



# AGENDA GIORNALIERA **17x24**



## AD 1613 MAXI AGENDA RISTORANTI A4

Copertina in matra, interno multilingue da 576 pag. in carta usomano bianca 70g. - sabato e domenica in doppia pagina. Pagine con foratura parallela al dorso.

 Matra

 21 x 29,7 cm ca.

 10



# AGENDA **MAXI A4** PER RISTORANTI



PAGINE CON  
PERFORATURA





**AD 1614  
MAXI AGENDA  
GIORNALIERA A4**

Copertina in matra, interno multilingue da 384 pag. in carta usomano bianca 70g - sabato e domenica separati. Pagine con foratura parallela al dorso.

 Matra

 21 x 29,7 cm ca.

 10



# AGENDA GIORNALIERA **MAXI A4**

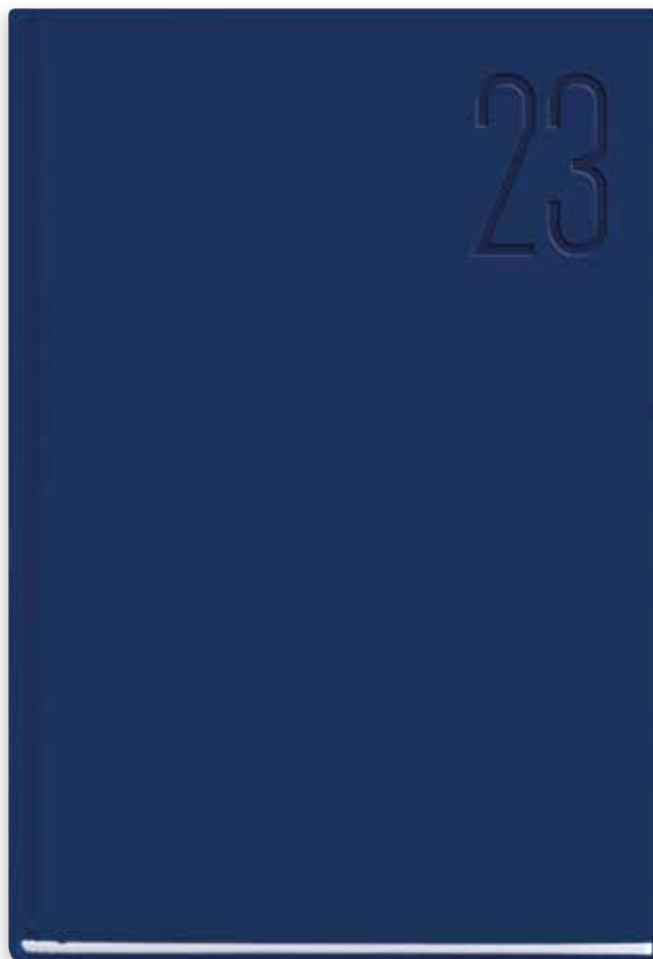

PAGINE CON  
PERFORATURA

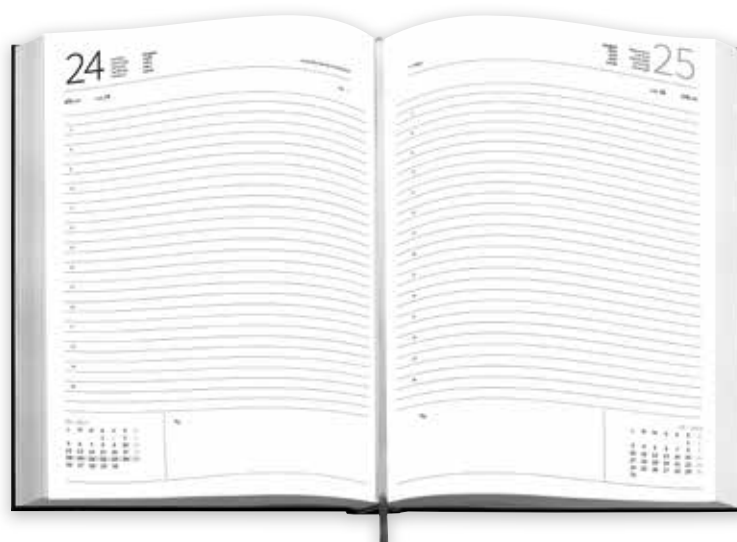

## AD 1640 AGENDINA SETTIMANALE 8x14

Copertina in matra, interno multilingue da  
128 pag. in carta usomano bianca **80g.**

 Matra

 8 x 14 cm ca.

 60



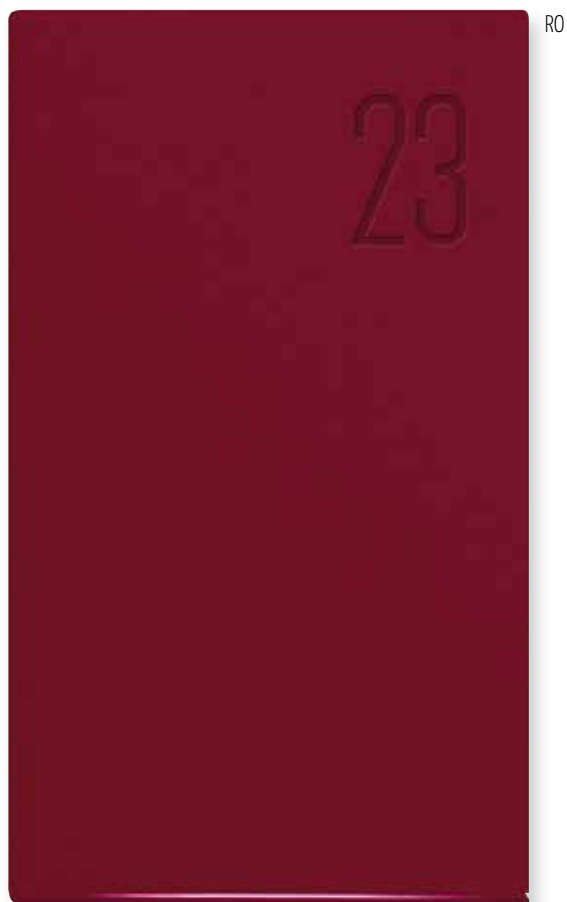

# AGENDINA SETTIMANALE **8x14**



**AD 1650  
PLANNING  
SETTIMANALE  
30X15**

Copertina in matra, interno multilingue da 128 pag. in carta usomano bianca **60g.**

-  Matra
-  30 x 15 cm ca.
-  25



# PLANNING SETTIMANALE



BL



VE



GR



RY



BO



RO



NE

## AD 1522 AGENDA

Agenda personalizzabile **full color**.  
Chiusura con elastico. Astuccio incluso.  
Minimo 300.

 Laminazione Soft Touch

 15 x 21 cm

 300



## AGENDA PERSONALIZZABILE **FULL COLOR**



CONFEZIONE  
IN ASTUCCIO



**promo**solution

**CALENDARI**

# CALENDARI

## AG 1776 ACQUERELLO NAPOLETANO

Calendario mensile 13 fogli. Carta patinata opaca stampa 4 colori. Testata rigida rinforzata in triplo cartoncino.

 Carta patinata opaca 90 gr

 Calendario 31 x 53 cm  
Testata 31 x 10,8 cm

 100

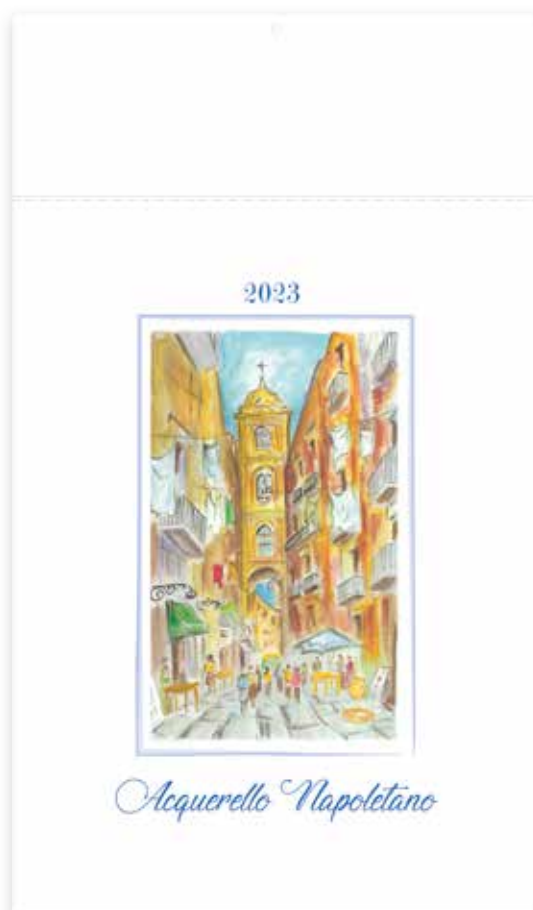

## AG 1778 ACQUERELLO NAPOLETANO DA TAVOLO

Spiralato 13 fogli carta patinata, planning 2023 e 2024 sul retro.

 Carta patinata opaca 100 gr



 Calendario 19 x 14,5 cm  
Spazio Stampa 19 x 4 cm

 100



## AG 1770 ACQUERELLO ITALIANO



Calendario mensile 13 fogli. Carta patinata opaca stampa 4 colori. Testata rigida rinforzata in triplo cartoncino.

-  Carta patinata opaca 90 gr
-  Calendario 31x 53 cm  
Spazio Stampa 31 x 10,8 cm
-  100



## AG 1775 ACQUERELLO ITALIANO DA TAVOLO

Spiralato 13 fogli carta patinata, planning 2023 e 2024 sul retro.





-  Carta patinata opaca 100 gr
-  Calendario 19 x 14,5 cm  
Spazio Stampa 19 x 4 cm
-  100



# CALENDARI

## AG 2000 PAPA FRANCESCO

Calendario mensile 12 fogli, Carta Patinata Stampa 4 colori fronte/retro, Festività Internazionali, Testata Termosaldata.

-  Carta patinata 70 gr
-  Calendario 28,8 x 47 cm
-  Testata 28,8 x 9 cm
-  100



### GENNAIO 2023

MESE	1	2	3	4	5	6	7	8	9	10	11	12	13	14	15	16	17	18	19	20	21	22	23	24	25	26	27	28	29	30	31
	DOM	LUN	MAR	MER	GIO	VEN	SAB	DOM	LUN	MAR	MER	GIO	VEN	SAB	DOM	LUN	MAR	MER	GIO	VEN	SAB	DOM	LUN	MAR	MER	GIO	VEN	SAB	DOM	LUN	MAR

*(Note: The calendar grid contains specific dates and events, including religious holidays like Epiphany and the start of the Lenten season.)*

### LA VITA DEL SANTO PADRE

#### JORGE MARIO RENDIGOLLO



*(This section is the beginning of a biographical article about Pope Francis, written by Jorge Mario Rendigollo. It discusses his early life and his path to becoming Pope.)*



GENNAIO



FEBBRAIO



MARZO



APRILE



MAGGIO



GIUGNO



LUGLIO



AGOSTO



SETTEMBRE



OTTOBRE



NOVEMBRE





DICEMBRE



## AG 2001 SAN PIO

Calendario mensile 12 fogli, Carta Patinata Stampa 4 colori fronte/retro, Festività Internazionali, Testata Termosaldata.

-  Carta patinata 70 gr
-  Calendario 28,8 x 47 cm  
Testata 28,8 x 9 cm
-  100

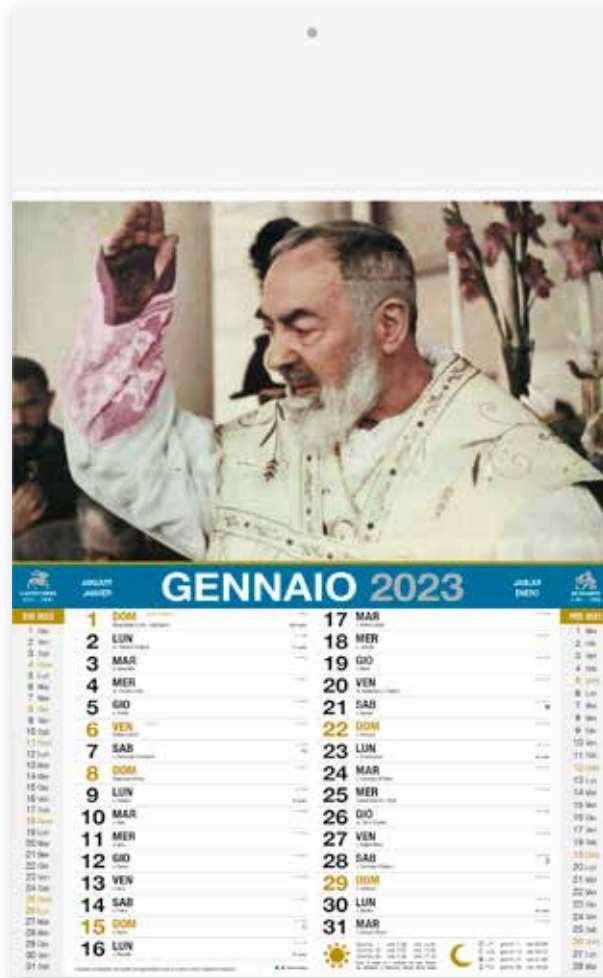
**GENNAIO 2023**

GEN	1 DOM	2 LUN	3 MAR	4 MER	5 GIO	6 VEN	7 SAB	8 DOM	9 LUN	10 MAR	11 MER	12 GIO	13 VEN	14 SAB	15 DOM	16 LUN	17 MAR	18 MER	19 GIO	20 VEN	21 SAB	22 DOM	23 LUN	24 MAR	25 MER	26 GIO	27 VEN	28 SAB	29 DOM	30 LUN	31 MAR
1	2	3	4	5	6	7	8	9	10	11	12	13	14	15	16	17	18	19	20	21	22	23	24	25	26	27	28	29	30	31	



### SAN PIO E GLI ANGELI

...mentemente ha formato il suo unico gruppo e si è dedicato al ministero del servizio sacerdotale. Il 1950, ordinato a Palermo, ha lavorato per anni in varie parrocchie e in diverse missioni, in particolare in Sicilia, dove ha fondato la Congregazione dei Missionari e ha fondato il Santuario di San Pio in Sicilia. Ha fondato anche il Santuario di San Pio in Sicilia e il Santuario di San Pio in Sicilia. Ha fondato anche il Santuario di San Pio in Sicilia e il Santuario di San Pio in Sicilia.



GENNAIO



FEBBRAIO



MARZO



APRILE



MAGGIO



GIUGNO



LUGLIO



AGOSTO



SETTEMBRE



OTTOBRE







NOVEMBRE



DICEMBRE

## AG 1950 CITTÀ ITALIANE

Calendario mensile 12 fogli, Carta Patinata Stampa 4 colori fronte/retro, Festività Internazionali, Testata Termosaldata.

-  Carta patinata 70 gr
-  Calendario 28,8 x 47 cm
-  Testata 28,8 x 9 cm
-  100



GENNAIO



FEBBRAIO



MARZO



APRILE



MAGGIO



GIUGNO



LUGLIO



AGOSTO



SETTEMBRE



OTTOBRE



NOVEMBRE



DICEMBRE

## Roma, la città eterna



La città eterna è un luogo unico, un luogo che ha visto nascere e crescere una delle civiltà più grandi e durature della storia. Roma è una città che ha saputo resistere al tempo, che ha saputo evolversi e che ha saputo rimanere fedele alle sue radici. È una città che ha saputo unire il passato e il presente, che ha saputo creare un ponte tra le epoche e che ha saputo dare un senso alla sua esistenza. Roma è una città che ha saputo essere una città aperta, una città che ha saputo accogliere e che ha saputo dare un senso alla sua esistenza. Roma è una città che ha saputo essere una città che ha saputo dare un senso alla sua esistenza.

## STREET FOOD

La street food a Roma: la qualità da non perdere

Quando parli del cibo di strada, pensi subito a un certo tipo di cucina, a un certo tipo di ingredienti, a un certo tipo di preparazione. Ma la street food è molto più che un semplice modo di cucinare, è un modo di vivere, un modo di essere, un modo di dare un senso alla tua vita.

Perché la street food è un modo di vivere, un modo di essere, un modo di dare un senso alla tua vita. È un modo di vivere che ha saputo unire il passato e il presente, che ha saputo creare un ponte tra le epoche e che ha saputo dare un senso alla sua esistenza.

Ma la street food è molto più che un semplice modo di cucinare, è un modo di vivere, un modo di essere, un modo di dare un senso alla tua vita. È un modo di vivere che ha saputo unire il passato e il presente, che ha saputo creare un ponte tra le epoche e che ha saputo dare un senso alla sua esistenza.

Perché la street food è un modo di vivere, un modo di essere, un modo di dare un senso alla tua vita. È un modo di vivere che ha saputo unire il passato e il presente, che ha saputo creare un ponte tra le epoche e che ha saputo dare un senso alla sua esistenza.

Ma la street food è molto più che un semplice modo di cucinare, è un modo di vivere, un modo di essere, un modo di dare un senso alla tua vita. È un modo di vivere che ha saputo unire il passato e il presente, che ha saputo creare un ponte tra le epoche e che ha saputo dare un senso alla sua esistenza.

Perché la street food è un modo di vivere, un modo di essere, un modo di dare un senso alla tua vita. È un modo di vivere che ha saputo unire il passato e il presente, che ha saputo creare un ponte tra le epoche e che ha saputo dare un senso alla sua esistenza.

Ma la street food è molto più che un semplice modo di cucinare, è un modo di vivere, un modo di essere, un modo di dare un senso alla tua vita. È un modo di vivere che ha saputo unire il passato e il presente, che ha saputo creare un ponte tra le epoche e che ha saputo dare un senso alla sua esistenza.

Perché la street food è un modo di vivere, un modo di essere, un modo di dare un senso alla tua vita. È un modo di vivere che ha saputo unire il passato e il presente, che ha saputo creare un ponte tra le epoche e che ha saputo dare un senso alla sua esistenza.

Ma la street food è molto più che un semplice modo di cucinare, è un modo di vivere, un modo di essere, un modo di dare un senso alla tua vita. È un modo di vivere che ha saputo unire il passato e il presente, che ha saputo creare un ponte tra le epoche e che ha saputo dare un senso alla sua esistenza.

Perché la street food è un modo di vivere, un modo di essere, un modo di dare un senso alla tua vita. È un modo di vivere che ha saputo unire il passato e il presente, che ha saputo creare un ponte tra le epoche e che ha saputo dare un senso alla sua esistenza.





Ma la street food è molto più che un semplice modo di cucinare, è un modo di vivere, un modo di essere, un modo di dare un senso alla tua vita. È un modo di vivere che ha saputo unire il passato e il presente, che ha saputo creare un ponte tra le epoche e che ha saputo dare un senso alla sua esistenza.

Perché la street food è un modo di vivere, un modo di essere, un modo di dare un senso alla tua vita. È un modo di vivere che ha saputo unire il passato e il presente, che ha saputo creare un ponte tra le epoche e che ha saputo dare un senso alla sua esistenza.

Ma la street food è molto più che un semplice modo di cucinare, è un modo di vivere, un modo di essere, un modo di dare un senso alla tua vita. È un modo di vivere che ha saputo unire il passato e il presente, che ha saputo creare un ponte tra le epoche e che ha saputo dare un senso alla sua esistenza.

## AG 1957 CITTÀ DEL MONDO

Calendario mensile 12 fogli, Carta Patinata Stampa 4 colori fronte/retro, Festività Internazionali, Testata Termosaldata.

-  Carta patinata 70 gr
-  Calendario 28,8 x 47 cm
-  Testata 28,8 x 9 cm
-  100



GENNAIO



FEBBRAIO



MARZO



APRILE



MAGGIO



GIUGNO



LUGLIO



AGOSTO



SETTEMBRE



OTTOBRE



NOVEMBRE







DICEMBRE



## AG 1965 HOME DESIGN

Calendario mensile 12 fogli, Carta Patinata Stampa 4 colori fronte/retro, Festività Internazionali, Testata Termosaldata.

-  Carta patinata 70 gr
-  Calendario 28,8 x 47 cm
-  Testata 28,8 x 9 cm
-  100



**GENNAIO 2023**

GEN	FEB	MAR	APR	MAG	JUN	LUG	AGO	SET	OCT	NOV	DIC
1 DOM	1 DOM	17 MAR	17 APR	17 MAG	17 JUN	17 LUG	17 AGO	17 SET	17 OCT	17 NOV	17 DIC
2 LUN	2 DOM	18 MER	18 APR	18 MAG	18 JUN	18 LUG	18 AGO	18 SET	18 OCT	18 NOV	18 DIC
3 MAR	3 DOM	19 GIO	19 APR	19 MAG	19 JUN	19 LUG	19 AGO	19 SET	19 OCT	19 NOV	19 DIC
4 MER	4 DOM	20 VEN	20 APR	20 MAG	20 JUN	20 LUG	20 AGO	20 SET	20 OCT	20 NOV	20 DIC
5 GIO	5 DOM	21 SAB	21 APR	21 MAG	21 JUN	21 LUG	21 AGO	21 SET	21 OCT	21 NOV	21 DIC
6 VEN	6 DOM	22 DOM	22 APR	22 MAG	22 JUN	22 LUG	22 AGO	22 SET	22 OCT	22 NOV	22 DIC
7 SAB	7 DOM	23 LUN	23 APR	23 MAG	23 JUN	23 LUG	23 AGO	23 SET	23 OCT	23 NOV	23 DIC
8 DOM	8 DOM	24 MAR	24 APR	24 MAG	24 JUN	24 LUG	24 AGO	24 SET	24 OCT	24 NOV	24 DIC
9 LUN	9 DOM	25 MER	25 APR	25 MAG	25 JUN	25 LUG	25 AGO	25 SET	25 OCT	25 NOV	25 DIC
10 MAR	10 DOM	26 GIO	26 APR	26 MAG	26 JUN	26 LUG	26 AGO	26 SET	26 OCT	26 NOV	26 DIC
11 MER	11 DOM	27 VEN	27 APR	27 MAG	27 JUN	27 LUG	27 AGO	27 SET	27 OCT	27 NOV	27 DIC
12 GIO	12 DOM	28 SAB	28 APR	28 MAG	28 JUN	28 LUG	28 AGO	28 SET	28 OCT	28 NOV	28 DIC
13 VEN	13 DOM	29 DOM	29 APR	29 MAG	29 JUN	29 LUG	29 AGO	29 SET	29 OCT	29 NOV	29 DIC
14 SAB	14 DOM	30 LUN	30 APR	30 MAG	30 JUN	30 LUG	30 AGO	30 SET	30 OCT	30 NOV	30 DIC
15 DOM	15 DOM	31 MAR	31 APR	31 MAG	31 JUN	31 LUG	31 AGO	31 SET	31 OCT	31 NOV	31 DIC
16 LUN	16 DOM										



GENNAIO



FEBBRAIO



MARZO



APRILE



MAGGIO



GIUGNO



LUGLIO



AGOSTO



SETTEMBRE



OTTOBRE



NOVEMBRE



DICEMBRE

## HOME E DESIGN

IL DESIGN MENDRAVISTA



Per chi ama un stile minimalista, una stanza con linee pulite e colori tenui è la soluzione ideale. In questo spazio, la luce naturale si fonde con quella artificiale, creando un'atmosfera accogliente e rilassante. Il design è funzionale e moderno, con un tocco di eleganza che si riflette in ogni dettaglio.







Qualità per chi spazia. In stile minimalista, il design Mendravista è un'ispirazione per chi ama un'atmosfera accogliente e rilassante. Il design è funzionale e moderno, con un tocco di eleganza che si riflette in ogni dettaglio.

**01**

# CALENDARI

## AG 1897 FAVOLE

Calendario mensile 12 fogli, Carta Patinata Stampa 4 colori fronte/retro, Festività Internazionali, Testata Termosaldata.

-  Carta patinata 70 gr
-  Calendario 28,8 x 47 cm
-  Testata 28,8 x 9 cm
-  100



GENNAIO



FEBBRAIO



MARZO



APRILE



MAGGIO



GIUGNO



LUGLIO



AGOSTO



SETTEMBRE



OTTOBRE





NOVEMBRE



DICEMBRE

## AG 2021 CUCCIOLI

Calendario mensile 12 fogli, Carta Patinata Stampa 4 colori fronte/retro, Festività Internazionali, Testata Termosaldata.

-  Carta patinata 70 gr
-  Calendario 28,8 x 47 cm  
Testata 28,8 x 9 cm
-  100



**GENNAIO 2023**

1	DOM	17	MAR	31	MAR
2	LUN	18	MER	28	SAB
3	MAR	19	GIO	29	DOM
4	MER	20	VEN	30	LUN
5	GIO	21	SAB	31	MAR
6	VEN	22	DOM		
7	SAB	23	LUN		
8	DOM	24	MAR		
9	LUN	25	MER		
10	MAR	26	GIO		
11	MER	27	VEN		
12	GIO	28	SAB		
13	VEN	29	DOM		
14	SAB	30	LUN		
15	DOM				
16	LUN				

### Cane e gatto possono convivere?



**Separati in casa**

Le tensioni scoppiano quando i loro cuccioli sono ancora piccoli. In una casa già abitata da un cane adulto, il cucciolo di gatto, dopo un'attenta preparazione, prende confidenza con l'ambiente e inizia ad abituarlo a proporre il gioco al cane. A questo punto entra in scena il nostro fedele amico: si avvicina, si accarezza e si affeziona. Può poi verificarsi una terza reazione: i cuccioli si avvicinano, e a questo punto si vede una strana compattezza, quasi come gli "appiccicati" del cinema, quando si è in famiglia e non si può che abbracciarsi all'istante. È un'emozione per una famiglia che si sta costruendo, e che si sta costruendo con il cane e il gatto. A questo punto non si deve più preoccupare di separarli, ma di mantenerli insieme.

**Chi ha detto che non si può?**  
Cane e gatto possono convivere in armonia e amicizia. In una casa già abitata da un cane adulto, il cucciolo di gatto, dopo un'attenta preparazione, prende confidenza con l'ambiente e inizia ad abituarlo a proporre il gioco al cane. A questo punto entra in scena il nostro fedele amico: si avvicina, si accarezza e si affeziona. Può poi verificarsi una terza reazione: i cuccioli si avvicinano, e a questo punto si vede una strana compattezza, quasi come gli "appiccicati" del cinema, quando si è in famiglia e non si può che abbracciarsi all'istante. È un'emozione per una famiglia che si sta costruendo, e che si sta costruendo con il cane e il gatto. A questo punto non si deve più preoccupare di separarli, ma di mantenerli insieme.



GENNAIO



FEBBRAIO



MARZO



APRILE



MAGGIO



GIUGNO



LUGLIO



AGOSTO



SETTEMBRE



OTTOBRE







NOVEMBRE



DICEMBRE

## AG 1962 LUNARIO

Calendario mensile 12 fogli, Carta Patinata Stampa 4 colori fronte/retro, Festività Internazionali, Testata Termosaldata.

-  Carta patinata 70 gr
-  Calendario 28,8 x 47 cm
-  Testata 28,8 x 9 cm
-  100





# GENNAIO 2023



<b>1</b> DOM		<b>MAR</b> 17	
<b>2</b> LUN		<b>MER</b> 18	
<b>3</b> MAR		<b>GIO</b> 19	
<b>4</b> MER		<b>VEN</b> 20	
<b>5</b> GIO		<b>SAB</b> 21	
<b>6</b> VEN		<b>DOM</b> 22	
<b>7</b> SAB		<b>LUN</b> 23	
<b>8</b> DOM		<b>MAR</b> 24	
<b>9</b> LUN		<b>MER</b> 25	
<b>10</b> MAR		<b>GIO</b> 26	
<b>11</b> MER		<b>VEN</b> 27	
<b>12</b> GIO		<b>SAB</b> 28	
<b>13</b> VEN		<b>DOM</b> 29	
<b>14</b> SAB		<b>LUN</b> 30	
<b>15</b> DOM		<b>MAR</b> 31	
<b>16</b> LUN			

DICEMBRE 2022		GENNAIO 2023		FEBBRAIO 2023	
1	2	3	4	5	6
7	8	9	10	11	12
13	14	15	16	17	18
19	20	21	22	23	24
25	26	27	28	29	30

## LA LUNA ED IL MARE



Le forze gravitazionali tra la Terra e la Luna sono causa di un interessante effetto: le maree. L'attrazione gravitazionale lunare è più forte sul lato della Terra più vicino alla Luna e più debole sul lato opposto. Dato che possiamo considerare la Terra come una sfera solida circondata da un involucro d'acqua, esse subisce un allungamento in direzione della Luna. L'effetto è molto più evidente negli oceani piuttosto che nella crosta terrestre ed è per tale motivo che notiamo maggiormente i rigonfiamenti dell'acqua. L'altezza dell'onda di marea è data dal divario tra alta e bassa marea: è massima quando Terra, Luna e Sole sono allineati, sia in congiunzione sia in opposizione (soligio); è minima quando la Luna si trova a 90° con l'allineamento Terra-Sole (quadratura). Tale fenomeno si ripete in ogni località con cadenza di 12h 25m, metà del giorno lunare medio pari a 24h 50m. Le onde di marea sono causa di due interessanti effetti: il rallentamento della rotazione terrestre e l'allentamento della Luna. I rigonfiamenti mareali, incorporando l'energia rappresentata dai continenti, esercitano un attrito che provoca la riduzione della velocità di rotazione terrestre: la durata del giorno aumenta di circa un secondo ogni centomila anni. La seconda conseguenza dell'attrito delle maree è la variazione della distanza Terra-Luna (quadruplica centomila anni). Questi cambiamenti avvengono a causa delle osservazioni del momento angolare del sistema Terra-Luna, in quanto la Terra reagisce al "trono" causato dalla marea "spendibile" la Luna. La Luna non è un astro che irradia luce propria: in particolare, la maggior quantità di luce che la Luna riflette proviene dal Sole, che la illumina pressoché costantemente. Finché non vediamo sempre la Luna illuminata completamente, ma ne vediamo, per la maggior parte del tempo, solo delle "fasi". La risposta sta in una specie di gioco di specchi: il Sole è come una lampadina, la Luna uno specchio e noi sulla Terra siamo ad osservare. La porzione di Luna che riusciamo a vedere illuminata dipende dalla posizione reciproca che i tre elementi assumono. Le fasi lunari avvengono come segue: se la Luna è fra la Terra ed il Sole, il lato della Terra è invisibile (neogiochi); il suo lato non illuminato (luna nuova). Di giorno in giorno comincerà ad apparire una falce sempre più conspicua e quando la Luna si troverà invece a circa 90° con l'allineamento Terra-Sole si noterà una falce di circa metà diametro lunare (prima quarto o mezza luna crescente).









# CALENDARI

## AG 2020 CABALA

Calendario mensile 12 fogli, Carta Patinata Stampa 4 colori fronte/retro, Festività Internazionali, Testata Termosaldata.

- Carta patinata 70 gr
- Calendario 28,8 x 47 cm
- Testata 28,8 x 9 cm
- 100



### GENNAIO 2023

1 DOM	LA BAMBINA A PICCIARELLA	MAR 17
2 LUN	L'ITALIA A GATTA	MER 18
3 MAR	LA GATTA A GATTA	GIO 19
4 MER	IL MASALE O PUSIRIO	VEN 20
5 GIO	LA MANO A MANGI	SAB 21
6 VEN	QUELLA CHE GUARDA A TERRA	DOM 22
7 SAB	IL VASO O VASSE	LUN 23
8 DOM	LA MADONNA A MADONNA	MAR 24
9 LUN		MER 25
10 MAR		GIO 26
11 MER		VEN 27
12 GIO		SAB 28
13 VEN		DOM 29
14 SAB		LUN 30
15 DOM		MAR 31
16 LUN		

**12** L'ITALIA A GATTA  
**2** LA BAMBINA A PICCIARELLA  
**3** LA GATTA A GATTA  
**4** IL MASALE O PUSIRIO  
**5** LA MANO A MANGI  
**6** QUELLA CHE GUARDA A TERRA  
**7** IL VASO O VASSE  
**8** LA MADONNA A MADONNA

**DICEMBRE 2022**      **FEBBRAIO 2023**



*Vincere al lotto:  
Un metodo antico  
3 secoli*

Esiste un metodo sicuro per vincere al lotto? A questo pare da un po' di tempo la buona parte, si parla di un metodo preciso e perfetto per vincere, che risale alla addirittura al 1634. Il metodo di Padre Pacifico.

Padre Pacifico è un frate che intorno al 1630 inventò il modo da per vincere al gioco del lotto. In quel periodo era sotto la gestione della Santa Pontificia sotto Papa Gregorio XVI. Egli inventò un modo per vincere al lotto, che consisteva nel giocare su un numero, e dice di aver vinto al lotto, dice di aver vinto al lotto con una scommessa. Egli inventò il modo da per vincere al lotto, dice di aver vinto al lotto, dice di aver vinto al lotto con una scommessa.

«Tanto se vincerai, perché credi ai numeri? Se dici che se vincerai, allora vincerai?». Per alcuni non era soltanto una buona battuta, ma un avvertimento: i numeri interpretando come tutti la parola di Padre Pacifico.

«Tanto se vincerai (04) perché vincerai se non? (10) Se dici che se vincerai (14-05) Allora vincerai? (4)»

Chi fece questo a gioco i soprannomi numeri, pare che fosse la sua stessa. Il metodo di Padre Pacifico per vincere al gioco del lotto, è un sistema basato su una serie di calcoli matematici, che consistono da una serie di calcoli di probabilità piuttosto semplici. Secondo che esistano le valenze di questo sistema, è necessario fare questi calcoli con estrema precisione, e da qui scaturiscono due numeri da giocare.

Secondo Padre Pacifico, creatore del metodo, la percentuale di vincita sarebbe così determinata:

- Andare a sottotto: probabilità 100 per cento
- Andare a sopra: probabilità 50 per cento
- Andare a indovinare: probabilità 25 per cento

Verità, o in alcune battute scherzose nel tempo? Secondo ai commentari che circolano sul web, sempre chiaramente da prendere con il dovuto beneficio del dubbio, il metodo di Padre Pacifico è davvero un metodo sicuro per vincere al lotto, per scoprirlo bisogna andare a leggere il manuale di 12 pagine del frate e ovviamente giocare, sperando che accada qualcosa.



GENNAIO



FEBBRAIO



MARZO



APRILE



MAGGIO



GIUGNO



LUGLIO



AGOSTO



SETTEMBRE



OTTOBRE



NOVEMBRE







DICEMBRE



# CALENDARI

## AG 1892 PIZZA

Calendario mensile 12 fogli, Carta Patinata Stampa 4 colori fronte/retro, Festività Internazionali, Testata Termosaldata.

-  Carta patinata 70 gr
-  Calendario 28,8 x 47 cm
-  Testata 28,8 x 9 cm
-  100



Gennaio 2023		Gennaio 2023	
1 DOM	17 MAR	18 MER	19 GIO
2 LUN	18 MER	19 GIO	20 VEN
3 MAR	19 GIO	20 VEN	21 SAB
4 MER	20 VEN	21 SAB	22 DOM
5 GIO	21 SAB	22 DOM	23 LUN
6 VEN	22 DOM	23 LUN	24 MAR
7 SAB	23 LUN	24 MAR	25 MER
8 DOM	24 MAR	25 MER	26 GIO
9 LUN	25 MER	26 GIO	27 VEN
10 MAR	26 GIO	27 VEN	28 SAB
11 MER	27 VEN	28 SAB	29 DOM
12 GIO	28 SAB	29 DOM	30 LUN
13 VEN	29 DOM	30 LUN	31 MAR
14 SAB	30 LUN	31 MAR	
15 DOM			
16 LUN			



### La pizza napoletana

La pizza napoletana rappresenta una tradizione che si è conservata nel tempo, mantenendo intatto il suo sapore e la sua autenticità.

La pizza napoletana è un piatto che ha conquistato il mondo intero, diventando uno dei cibi più amati e consumati in tutto il mondo. La sua storia è legata a Napoli, città che ha dato origine a questo piatto che ha conquistato il mondo intero.



GENNAIO



FEBBRAIO



MARZO



APRILE



MAGGIO



GIUGNO



LUGLIO



AGOSTO



SETTEMBRE



OTTOBRE



NOVEMBRE



DICEMBRE

## AG 1984 PANE

Calendario mensile 12 fogli, Carta Patinata Stampa 4 colori fronte/retro, Festività Internazionali, Testata Termosaldata.

**i** Carta patinata 70 gr  
**📏** Calendario 28,8 x 47 cm  
**📏** Testata 28,8 x 9 cm

**👁** 100



GENNAIO



FEBBRAIO



MARZO



APRILE



MAGGIO



GIUGNO



LUGLIO



AGOSTO



SETTEMBRE



OTTOBRE



NOVEMBRE







DICEMBRE

# CALENDARI

## AG 1970 ECCELLENZE ITALIANE

Calendario mensile 12 fogli, Carta Patinata Stampa 4 colori fronte/retro, Festività Internazionali, Testata Termosaldata.

-  Carta patinata 70 gr
-  Calendario 28,8 x 47 cm
-  Testata 28,8 x 9 cm
-  100



### Mozzarella di Bufala

La mozzarella di bufala campana è un prodotto casareo dell'Italia meridionale, prodotto tradizionalmente in Campania, soprattutto nelle province di Caserta e Salerno. La produzione di questo formaggio tipico si svolge anche in altre parti della Campania molisana, nel Lazio meridionale, nel Gargano e nei comuni di Venafra e Molise. Il termine mozzarella deriva dal nome dell'operazione di mozzatura compiuta per separare il formaggio in singoli pezzi. Il sapore della mozzarella di bufala campana è caratteristico, ma anche un buon gusto di latte di vacca, in omaggio al proprio gusto dolce e a quello del prodotto.



### Protezione

Questo tipo di mozzarella è prodotta solo con latte di vacca e senza l'aggiunta di latte di capra o di pecora. Gli animali che producono latte di vacca sono allevati in modo etico e rispettando il benessere animale. Il latte di vacca viene pastorizzato e conservato in frigorifero per garantire la freschezza e la qualità del prodotto. La mozzarella di bufala campana è un prodotto che si conserva bene in frigorifero e può essere consumata anche a temperatura ambiente. È un prodotto che si presta bene per essere utilizzato in una varietà di ricette, dalla pizza alla pasta, dalla focaccia al panino.

### Denominazione Origine

Il termine "Denominazione di Origine Protetta" (DOP) è un marchio che garantisce al consumatore la qualità e l'autenticità del prodotto. La mozzarella di bufala campana ha ottenuto questo marchio nel 2009. Questo significa che solo i prodotti che rispettano le regole di produzione e di controllo previste dal regolamento europeo possono essere commercializzati con questo marchio. La mozzarella di bufala campana è un prodotto che si distingue per il suo sapore dolce e cremoso, e per la sua consistenza morbida e saporita. È un prodotto che si presta bene per essere utilizzato in una varietà di ricette, dalla pizza alla pasta, dalla focaccia al panino.



GENNAIO



FEBBRAIO



MARZO



APRILE



MAGGIO



GIUGNO



LUGLIO



AGOSTO



SETTEMBRE



OTTOBRE



NOVEMBRE



DICEMBRE

## AG 2023 CUCINA

Calendario mensile 12 fogli, Carta Patinata Stampa 4 colori fronte/retro, Festività Internazionali, Testata Termosaldata.

**i** Carta patinata 70 gr  
**📏** Calendario 28,8 x 47 cm  
**📏** Testata 28,8 x 9 cm

**👁️** 100



### Spaghetti alla carbonara

**Ingredienti**

- 400 gr di spaghetti
- 1 uovo
- 150 gr di pancetta secca
- 100 gr di pecorino romano
- olio extravergine d'oliva
- pepe e sale q.b.

**Preparazione**

Stufare a moderato il pancetta e macinato e soffriggere in essa per 10 minuti il guanciale con il sugo. Mescolare anche un uovo di uovo e la macinata il guanciale con il sugo.

In una pentola grande a parte cuocere in acqua bollente il pancetta con il sugo.

Cuocere gli spaghetti in abbondante acqua salata e scolarli al dente.

Miscelare gli spaghetti nella pentola con il sugo. Togliere subito dalla pentola e condire con il pecorino romano.

Decorare gli spaghetti nella pentola con il sugo e il pecorino romano.

Decorare gli spaghetti con il sugo e il pecorino romano.



GENNAIO



FEBBRAIO



MARZO



APRILE



MAGGIO



GIUGNO



LUGLIO



AGOSTO



SETTEMBRE



OTTOBRE



NOVEMBRE





DICEMBRE

# CALENDARI

## AG 2026 CARNE IN TAVOLA

Calendario mensile 12 fogli, Carta Patinata Stampa 4 colori fronte/retro, Festività Internazionali, Testata Termosaldata.

-  Carta patinata 70 gr
-  Calendario 28,8 x 47 cm  
Testata 28,8 x 9 cm
-  100



GENNAIO 2023		
1	DOM	17 MAR
2	LUN	18 MER
3	MAR	19 GIO
4	MER	20 VEN
5	GIO	21 SAB
6	VEN	22 DOM
7	SAB	23 LUN
8	DOM	24 MAR
9	LUN	25 MER
10	MAR	26 GIO
11	MER	27 VEN
12	GIO	28 SAB
13	VEN	29 DOM
14	SAB	30 LUN
15	DOM	31 MAR
16	LUN	



GENNAIO



FEBBRAIO



MARZO



APRILE



MAGGIO



GIUGNO



LUGLIO



AGOSTO



SETTEMBRE



OTTOBRE



NOVEMBRE



DICEMBRE

### BISTECCA ALLA PIASTRA

con peperoncino



**INGREDIENTI**

1 bistecca di manzo a 2 cm di spessore  
100 g di peperoncino  
100 g di olio d'oliva  
100 g di sale grosso

**PREPARAZIONE**



Per prima cosa tagliare la carne con molta cura, in modo che sia per dimensioni circa 10x10 cm, sia per spessore (circa 2 cm). Tagliare il peperoncino in piccoli pezzi e metterlo in un mortaio con il sale grosso. Battere bene il tutto con un pestello. Spalmare la carne con il sale grosso e il peperoncino. Lasciare riposare la carne per 10 minuti. Mettere la carne sulla piastra e cuocerla per 5 minuti per lato. Servire con il sale grosso e il peperoncino.





## AG 2027 SAPORI DEL MARE

Calendario mensile 12 fogli, Carta Patinata Stampa 4 colori fronte/retro, Festività Internazionali, Testata Termosaldata.

-  Carta patinata 70 gr
-  Calendario 28,8 x 47 cm
-  Testata 28,8 x 9 cm

 100



**Merluzzo in salsa di sgrani**

**INGREDIENTI**  
 4 Filetti di merluzzo  
 2 Litri  
 1/2 Bicchiere di vino bianco  
 1/2 cucchiaino di erbe  
 Sale  
 2 Pomodori  
 2 Anziche  
 Un mazzetto  
 di finocchio selvatico  
 200g

**PREPARAZIONE**  
 Mettere i 4 filetti di merluzzo in una padella antiaderente e far grigliare con il nocciolo di pangrattato, con 1 bicchiere di vino bianco, salare e far rosolare in forno bollente a 180°C per 20 minuti.  
 Nel frattempo pulire e tagliare gli spinaci tagliando le foglie. Salare e preparare la salsa mescolando la poltiglia di bone.  
 A fine cottura del merluzzo, aggiungere il vino e il sale, far cuocere per 10 minuti.  
 Unire il finocchio selvatico e far cuocere in salamoia per 10 minuti.  
 Conoscere: accompagnare con verdure di stagione.



GENNAIO



FEBBRAIO



MARZO



APRILE



MAGGIO



GIUGNO



LUGLIO



AGOSTO



SETTEMBRE



OTTOBRE



NOVEMBRE





DICEMBRE

# CALENDARI

## AG 1987 FRUTTA & VERDURA

Calendario mensile 12 fogli, Carta Patinata Stampa 4 colori fronte/retro, Festività Internazionali, Testata Termosaldata.

-  Carta patinata 70 gr
-  Calendario 28,8 x 47 cm  
Testata 28,8 x 9 cm
-  100



### ALIMENTO FONDAMENTALE DELLA NOSTRA DIETA...PERCHÉ?

La frutta, alimento fondamentale della nostra dieta, garantisce l'assunzione della maggior parte delle sostanze nutritive di cui il nostro organismo ha bisogno. Tra i più importanti possiamo citare le vitamine, le proteine, diversi sali minerali, zuccheri semplici, acqua e fibre. I maggiori vantaggi che si possono trarre dall'assumere frutta si hanno al mattino o nella mezzogiornata. In pratica, la frutta non dovrebbe essere ingerita insieme ad altri cibi-dati che, quando viene consumata a fine pasto, ritardando a lungo nell'apparato digerente va incontro facilmente alla fermentazione degli zuccheri in essa presenti, causando quello che comunemente chiamiamo gonfiore intestinale. L'assunzione continuata di vitamine e sali minerali garantisce un elevato potere antiossidante

così da proteggere il nostro organismo dai pericoli dei radicali liberi.

Mangiare frutta vuol dire quindi prevenire anche l'insorgere di tumori. Ad esclusione di alcuni frutti come l'avenca, la frutta è praticamente priva di grassi risultando così un ottimo alimento da assumere durante la dieta ipocalorica. La frutta inoltre, assumendo molta di acqua, favorisce l'idratazione del corpo soprattutto nei periodi estivi e durante le attività sportive. Il utile mangiare regolarmente la frutta, come da sempre è stato suggerito, costituisce infatti un alimento indispensabile a tutte le età e in tutte le stagioni. Gli eccessi sono comunque sempre sconsigliati: una dieta a base di frutta non solo non è utile per la nostra salute ma non è neppure equilibrata.



GENNAIO



FEBBRAIO



MARZO



APRILE



MAGGIO



GIUGNO



LUGLIO



AGOSTO



SETTEMBRE



OTTOBRE





NOVEMBRE



DICEMBRE

## AG 1988 DOLCI E PIACERI

Calendario mensile 12 fogli, Carta Patinata Stampa 4 colori fronte/retro, Festività Internazionali, Testata Termosaldata.

-  Carta patinata 70 gr
-  Calendario 28,8 x 47 cm
-  Testata 28,8 x 9 cm

 100



GENNAIO



FEBBRAIO



MARZO



APRILE



MAGGIO



GIUGNO



LUGLIO



AGOSTO



SETTEMBRE



OTTOBRE



NOVEMBRE





DICEMBRE

# CALENDARI

## AG 1840 FORMULA UNO

Bimensile 6 fogli, carta patinata  
stampa 4 colori. Testata termosaldata.

-  Carta patinata 80 gr
-  Calendario 32 x 48 cm  
Testata 32 x 10 cm
-  100



Formula 1

**GENNAIO 2023 FEBBRAIO**



1	2	3	4	5	6	7	8	9	10	11	12	13	14	15	16	17	18	19	20	21	22	23	24	25	26	27	28	29	30	31
1	2	3	4	5	6	7	8	9	10	11	12	13	14	15	16	17	18	19	20	21	22	23	24	25	26	27	28	29	30	31

**ITALY**  
**IMOLA**



## AG 1845 MOTO GP

Bimensile 6 fogli, carta patinata  
stampa 4 colori. Testata termosaldata.

-  Carta patinata 80 gr
-  Calendario 32 x 48 cm  
Testata 32 x 10 cm
-  100



### GENNAIO 2023 FEBBRAIO

GENNAIO		 MISANO		FEBBRAIO	
1	14	27	1	6	19
2	15	28	2	7	20
3	16	29	3	8	21
4	17	30	4	9	22
5	18	31	5	10	23
6	19			11	24
7	20			12	25
8	21			13	26
9	22			14	27
10	23			15	28
11	24			16	
12	25			17	
13	26			18	



## AG 2044 SILHOUETTE CUCINA

Calendario mensile 12 fogli, Carta Patinata Stampa 4 colori fronte/retro, Festività Internazionali, Testata Termosaldata.

- Carta patinata 70 gr
- Calendario 14 x 47 cm  
Testata 14 x 9 cm
- 100



## AG 2047 SILHOUETTE CARNE IN TAVOLA

Calendario mensile 12 fogli, Carta Patinata Stampa 4 colori fronte/retro, Festività Internazionali, Testata Termosaldata.



- Carta patinata 70 gr
- Calendario 14 x 47 cm  
Testata 14 x 9 cm
- 100

RETRO

**GENNAIO 2023**

1 Dom	17 Mar
2 Lun	18 Mer
3 Mar	19 Gio
4 Mer	20 Ven
5 Gio	21 Sab
6 Ven	22 Dom
7 Sab	23 Lun
8 Dom	24 Mar
9 Lun	25 Mer
10 Mar	26 Gio
11 Mer	27 Ven
12 Gio	28 Sab
13 Ven	29 Dom
14 Sab	30 Lun
15 Dom	31 Mar
16 Lun	

**CUCINA**

**DICEMBRE 2022**      **FEBBRAIO 2023**

1	2	3	4	5	6	7	8	9	10	11	12
13	14	15	16	17	18	19	20	21	22	23	24
25	26	27	28	29	30	31					



### Ingredienti Preparazione

**Ingredienti**  
-400 gr di spaghetti  
-10 uova  
-120 gr di guanciale  
-100 gr di prosciutto cotto  
-olio extravergine d'oliva  
-pepe e sale q.b.

**Preparazione**  
Riscaldare a bollitura il pancino e metterlo a soffriggere in una padella con un po' d'olio. Passare anche un po' di salsiccia. Farlo rosolare il guanciale solo nel suo grasso. In una cassetta grande si fanno bollire le uova aggiungendo il prosciutto cotto tagliato a cubetti. Cuocere gli spaghetti in abbondante acqua salata e scolati si deve scuotere bene la pasta con il guanciale. Bontà di avere guanciale sottile, quindi mescolarlo nella cassetta con la pasta e il prosciutto cotto tagliato a cubetti. Aggiungere gli spaghetti nella cassetta con il prosciutto e mescolarlo con la pasta. Coprire il piatto con la salsa e servire con il prosciutto cotto e il guanciale. Il segreto per ottenere un piatto di pasta alla carbonara è quello di non cuocerla in acqua bollente e non più che al momento di servire.

GENNAIO      FEBBRAIO

MARZO      APRILE

MAGGIO      GIUGNO

LUGLIO      AGOSTO

SETTEMBRE      OTTOBRE

NOVEMBRE      DICEMBRE

**GENNAIO 2023**

1 Dom	17 Mar
2 Lun	18 Mer
3 Mar	19 Gio
4 Mer	20 Ven
5 Gio	21 Sab
6 Ven	22 Dom
7 Sab	23 Lun
8 Dom	24 Mar
9 Lun	25 Mer
10 Mar	26 Gio
11 Mer	27 Ven
12 Gio	28 Sab
13 Ven	29 Dom
14 Sab	30 Lun
15 Dom	31 Mar
16 Lun	

**CARNE IN TAVOLA**

**DICEMBRE 2022**      **FEBBRAIO 2023**

1	2	3	4	5	6	7	8	9	10	11	12
13	14	15	16	17	18	19	20	21	22	23	24
25	26	27	28	29	30	31					

**BISTECCA ALLA PIASTRA**  
con pepe nero

**INGREDIENTI**  
-1 bistecca di manzo di 1 kg  
-100 g di prosciutto cotto  
-olio extravergine d'oliva  
-pepe nero macinato a piacere



**PREPARAZIONE**  
Per prima cosa tagliare la bistecca in due parti da bollire, una per bollire e una per arrostiti. Mettere il prosciutto cotto a bollire in acqua bollente. Cuocere la bistecca in acqua bollente per 10 minuti. Scolare la carne e metterla in una padella con olio e prosciutto cotto. Arrostiti la carne in una piastra con olio e prosciutto cotto. Servire con la carne e il prosciutto cotto.



# CALENDARI

## AG 2040 SILHOUETTE MULTICOLOR



Calendario mensile 12 fogli, Carta Patinata Stampa 4 colori fronte/retro, Planning 2024 sul retro dicembre, Festività Internazionali, Testata Termosaldata.

-  Carta patinata 70 gr
-  Calendario 14 x 47 cm  
Testata 14 x 9 cm
-  100



## AG 2041 SILHOUETTE STYLE

Calendario mensile 12 fogli, Carta Patinata Stampa 4 colori fronte/retro, Planning 2024 sul retro dicembre, Festività Internazionali, Testata Termosaldata.

-  Carta patinata 70 gr
-  Calendario 14 x 47 cm  
Testata 14 x 9 cm
-  100



RETRO



RETRO





## AG 2068 OLANDESE MULTICOLOR

Calendario mensile 12 fogli. Testata rinforzata



- Carta patinata opaca 90 gr
- Calendario 31 x 53 cm  
Testata 31 x 10,8 cm
- 100

## AG 2069 SILHOUETTE MULTICOLOR

Calendario mensile 12 fogli. Testata rinforzata



- Carta patinata opaca 90 gr
- Calendario 22,5 x 59,5 cm  
Testata 22,5 x 10,8 cm
- 100





DIC 2022		GENNAIO 2023		FEB 2023	
1 GIO	<b>01</b> <b>Domenica</b> Maria Madre di Dio	<b>17</b> <b>Martedì</b> s. Antonio abate	1 MER		
2 VEN	<b>02</b> <b>Lunedì</b> ss. Basilio e Gregorio	<b>18</b> <b>Mercoledì</b> s. Liberato	2 GIO		
3 SAB	<b>03</b> <b>Martedì</b> s. Gervasio	<b>19</b> <b>Giovedì</b> s. Maria	3 VEN		
4 DOM	<b>04</b> <b>Mercoledì</b> ss. Emidio e Cato	<b>20</b> <b>Venerdì</b> ss. Sebastiano e Fabiano	4 SAB		
5 LUN	<b>05</b> <b>Giovedì</b> s. Anna	<b>21</b> <b>Sabato</b> s. Agnese	5 DOM		
6 MAR	<b>06</b> <b>Venerdì</b> Eulalia di R.S.	<b>22</b> <b>Domenica</b> s. Vincenzo	6 LUN		
7 MER	<b>07</b> <b>Sabato</b> s. Remondo di Perleart	<b>23</b> <b>Lunedì</b> s. Eusebio	7 MAR		
8 GIO	<b>08</b> <b>Domenica</b> Battesimo di Gesù	<b>24</b> <b>Martedì</b> s. Francesco di Sales	8 MER		
9 VEN	<b>09</b> <b>Lunedì</b> s. Giuliana	<b>25</b> <b>Mercoledì</b> Convers. di s. Paolo	9 GIO		
10 SAB	<b>10</b> <b>Martedì</b> s. Rita	<b>26</b> <b>Giovedì</b> ss. Tito e Testato	10 VEN		
11 DOM	<b>11</b> <b>Mercoledì</b> s. Maria	<b>27</b> <b>Venerdì</b> s. Angela Merici	11 SAB		
12 LUN	<b>12</b> <b>Giovedì</b> s. Chiara	<b>28</b> <b>Sabato</b> s. Tommaso d'Aquino	12 DOM		
13 MAR	<b>13</b> <b>Venerdì</b> s. Rita	<b>29</b> <b>Domenica</b> s. Costanzo	13 LUN		
14 MER	<b>14</b> <b>Sabato</b> s. Felice	<b>30</b> <b>Lunedì</b> s. Marcellino	14 MAR		
15 GIO	<b>15</b> <b>Domenica</b> s. Maria	<b>31</b> <b>Martedì</b> s. Giovanni Evangelista	15 MER		
16 VEN	<b>16</b> <b>Lunedì</b> s. Marcello		16 GIO		
17 SAB			17 VEN		
			18 SAB		
			19 DOM		
			20 LUN		
			21 MAR		
			22 MER		
			23 GIO		
			24 VEN		
			25 SAB		
			26 DOM		
			27 LUN		
			28 MAR		

GENNAIO 2023	
<b>01</b> <b>Domenica</b> Epifania - Maria Madre di Dio	<b>17</b> <b>Martedì</b> s. Michele arc.
<b>02</b> <b>Lunedì</b> ss. Basilio e Gregorio	<b>18</b> <b>Mercoledì</b> s. Liberato
<b>03</b> <b>Martedì</b> s. Gervasio	<b>19</b> <b>Giovedì</b> s. Maria
<b>04</b> <b>Mercoledì</b> ss. Emidio e Cato	<b>20</b> <b>Venerdì</b> ss. Sebastiano e Fabiano
<b>05</b> <b>Giovedì</b> s. Anna	<b>21</b> <b>Sabato</b> s. Agnese
<b>06</b> <b>Venerdì</b> Eulalia di R.S.	<b>22</b> <b>Domenica</b> s. Vincenzo
<b>07</b> <b>Sabato</b> s. Remondo di Perleart	<b>23</b> <b>Lunedì</b> s. Eusebio
<b>08</b> <b>Domenica</b> Battesimo di Gesù	<b>24</b> <b>Martedì</b> s. Francesco di Sales
<b>09</b> <b>Lunedì</b> s. Giuliana	<b>25</b> <b>Mercoledì</b> Convers. di s. Paolo
<b>10</b> <b>Martedì</b> s. Rita	<b>26</b> <b>Giovedì</b> ss. Tito e Testato
<b>11</b> <b>Mercoledì</b> s. Maria	<b>27</b> <b>Venerdì</b> s. Angela Merici
<b>12</b> <b>Giovedì</b> s. Chiara	<b>28</b> <b>Sabato</b> s. Tommaso d'Aquino
<b>13</b> <b>Venerdì</b> s. Rita	<b>29</b> <b>Domenica</b> s. Costanzo
<b>14</b> <b>Sabato</b> s. Felice	<b>30</b> <b>Lunedì</b> s. Marcellino
<b>15</b> <b>Domenica</b> s. Maria	<b>31</b> <b>Martedì</b> s. Giovanni Evangelista
<b>16</b> <b>Lunedì</b> s. Marcello	

# CALENDARI

## AG 2010 OLANDESE MEDIUM

Calendario mensile 12 fogli, Carta Patinata, Stampa 2 colori, Planning 2024 sul retro dicembre, Festività Internazionali, Testata Termosaldata.

-  Carta patinata 70 gr
-  Calendario 28,8 x 42,5 cm
-  Testata 28,8 x 9 cm
-  100



BL

RETRO



RO







VE



## AG 2011 OLANDESE STANDARD

Calendario mensile 12 fogli, Carta Patinata, Stampa 2 colori, Planning 2024 sul retro dicembre, Festività Internazionali, Testata Termosaldata.

-  Carta patinata 70 gr
-  Calendario 28,8 x 47 cm
-  Testata 28,8 x 9 cm
-  100



RO

**GENNAIO 2023**

<b>1</b> <b>domenica</b> S. Maria	<b>17</b> <b>martedì</b> S. Maria
<b>2</b> <b>lunedì</b> S. Maria	<b>18</b> <b>mercoledì</b> S. Maria
<b>3</b> <b>martedì</b> S. Maria	<b>19</b> <b>giovedì</b> S. Maria
<b>4</b> <b>mercoledì</b> S. Maria	<b>20</b> <b>venerdì</b> S. Maria
<b>5</b> <b>giovedì</b> S. Maria	<b>21</b> <b>sabato</b> S. Maria
<b>6</b> <b>venerdì</b> S. Maria	<b>22</b> <b>domenica</b> S. Maria
<b>7</b> <b>sabato</b> S. Maria	<b>23</b> <b>domenica</b> S. Maria
<b>8</b> <b>domenica</b> S. Maria	<b>24</b> <b>martedì</b> S. Maria
<b>9</b> <b>lunedì</b> S. Maria	<b>25</b> <b>mercoledì</b> S. Maria
<b>10</b> <b>martedì</b> S. Maria	<b>26</b> <b>giovedì</b> S. Maria
<b>11</b> <b>mercoledì</b> S. Maria	<b>27</b> <b>venerdì</b> S. Maria
<b>12</b> <b>giovedì</b> S. Maria	<b>28</b> <b>sabato</b> S. Maria
<b>13</b> <b>venerdì</b> S. Maria	<b>29</b> <b>domenica</b> S. Maria
<b>14</b> <b>sabato</b> S. Maria	<b>30</b> <b>domenica</b> S. Maria
<b>15</b> <b>domenica</b> S. Maria	<b>31</b> <b>martedì</b> S. Maria

RETRO

**PLANNING 2024**

Grid showing monthly planning for 2024 with columns for months and rows for weeks.

BL

**GENNAIO 2023**

<b>1</b> <b>domenica</b>	<b>17</b> <b>martedì</b>
<b>2</b> <b>lunedì</b>	<b>18</b> <b>mercoledì</b>
<b>3</b> <b>martedì</b>	<b>19</b> <b>giovedì</b>
<b>4</b> <b>mercoledì</b>	<b>20</b> <b>venerdì</b>
<b>5</b> <b>giovedì</b>	<b>21</b> <b>sabato</b>
<b>6</b> <b>venerdì</b>	<b>22</b> <b>domenica</b>
<b>7</b> <b>sabato</b>	<b>23</b> <b>domenica</b>
<b>8</b> <b>domenica</b>	<b>24</b> <b>martedì</b>
<b>9</b> <b>lunedì</b>	<b>25</b> <b>mercoledì</b>
<b>10</b> <b>martedì</b>	<b>26</b> <b>giovedì</b>
<b>11</b> <b>mercoledì</b>	<b>27</b> <b>venerdì</b>
<b>12</b> <b>giovedì</b>	<b>28</b> <b>sabato</b>
<b>13</b> <b>venerdì</b>	<b>29</b> <b>domenica</b>
<b>14</b> <b>sabato</b>	<b>30</b> <b>domenica</b>
<b>15</b> <b>domenica</b>	<b>31</b> <b>martedì</b>

VE





**GENNAIO 2023**

<b>1</b> <b>domenica</b>	<b>17</b> <b>martedì</b>
<b>2</b> <b>lunedì</b>	<b>18</b> <b>mercoledì</b>
<b>3</b> <b>martedì</b>	<b>19</b> <b>giovedì</b>
<b>4</b> <b>mercoledì</b>	<b>20</b> <b>venerdì</b>
<b>5</b> <b>giovedì</b>	<b>21</b> <b>sabato</b>
<b>6</b> <b>venerdì</b>	<b>22</b> <b>domenica</b>
<b>7</b> <b>sabato</b>	<b>23</b> <b>domenica</b>
<b>8</b> <b>domenica</b>	<b>24</b> <b>martedì</b>
<b>9</b> <b>lunedì</b>	<b>25</b> <b>mercoledì</b>
<b>10</b> <b>martedì</b>	<b>26</b> <b>giovedì</b>
<b>11</b> <b>mercoledì</b>	<b>27</b> <b>venerdì</b>
<b>12</b> <b>giovedì</b>	<b>28</b> <b>sabato</b>
<b>13</b> <b>venerdì</b>	<b>29</b> <b>domenica</b>
<b>14</b> <b>sabato</b>	<b>30</b> <b>domenica</b>
<b>15</b> <b>domenica</b>	<b>31</b> <b>martedì</b>

# CALENDARI

## AG 2014 OLANDESE STANDARD MULTICOLOR

Calendario mensile 12 fogli, Carta Patinata, Stampa 2 colori, Planning 2024 sul retro dicembre, Festività Internazionali, Testata Termosaldata.

-  Carta patinata 70 gr
-  Calendario 28,8 x 47 cm
-  Testata 28,8 x 9 cm
-  100





RETRO



## AG 2015 OLANDESE TRENDY

Calendario mensile 12 fogli, Carta Patinata, Stampa 2 colori, Planning 2024 sul retro dicembre, Festività Internazionali, Testata Termosaldata.

-  Carta patinata 70 gr
-  Calendario 28,8 x 47 cm  
Testata 28,8 x 9 cm
-  100



BL

RETRO



RO







VE



# CALENDARI

## AG 2012 OLANDESE NOTES

Calendario mensile 12 fogli, Carta Patinata, Stampa 2 colori, Planning 2024 sul retro dicembre, Festività Internazionali, Testata Termosaldata.

-  Carta patinata 70 gr
-  Calendario 28,8 x 47 cm
-  Testata 28,8 x 9 cm
-  100



RO

RETRO



BL





VE



**AG 2060  
OLANDESE MAXI  
QUADRETTATO**

Mensile 12 fogli. Allestimento con  
astina metallica.

-  Carta uso mano 80 gr
-  Calendario 33 X 70 cm  
Testata 33 x 11 cm
-  100



		<b>GENNAIO 2023</b>			
	<b>1</b>	<b>DOMENICA</b> Maria Madre di Dio - Capodimonte 12 <sup>a</sup> fest.	<b>17</b>	<b>MARTEDI</b> s. Antonio abate	
<b>1 G</b>	<b>2</b>	<b>LUNEDI</b> ss. Basilio e Gregorio 7 <sup>a</sup> fest.	<b>18</b>	<b>MERCOLEDI</b> s. Liberata	<b>1 M</b>
<b>2 V</b>	<b>3</b>	<b>MARTEDI</b> s. Genesio	<b>19</b>	<b>GIOVEDI</b> s. Maria	<b>2 G</b>
<b>3 S</b>	<b>4</b>	<b>MERCOLEDI</b> ss. Emidio e Cato	<b>20</b>	<b>VENERDI</b> ss. Sebastiano e Paterno	<b>3 V</b>
<b>4 D</b>	<b>5</b>	<b>GIOVEDI</b> s. Anania	<b>21</b>	<b>SABATO</b> s. Agnese	<b>4 S</b>
<b>5 L</b>	<b>6</b>	<b>VENERDI</b> Santina e P.S.	<b>22</b>	<b>DOMENICA</b> s. Innocenzo	<b>5 D</b>
<b>6 M</b>	<b>7</b>	<b>SABATO</b> s. Raimondo di Peñafort	<b>23</b>	<b>LUNEDI</b> s. Eusebio	<b>6 L</b>
<b>7 M</b>	<b>8</b>	<b>DOMENICA</b> Santissimo di Gesù	<b>24</b>	<b>MARTEDI</b> s. Francesco di Sales	<b>7 M</b>
<b>8 G</b>	<b>9</b>	<b>LUNEDI</b> s. Giuliano 7 <sup>a</sup> fest.	<b>25</b>	<b>MERCOLEDI</b> Comeri di s. Paolo	<b>8 M</b>
<b>9 V</b>	<b>10</b>	<b>MARTEDI</b> s. Adalberto	<b>26</b>	<b>GIOVEDI</b> ss. Tito e Simeone	<b>9 G</b>
<b>10 S</b>	<b>11</b>	<b>MERCOLEDI</b> s. Igino	<b>27</b>	<b>VENERDI</b> s. Angela Merici	<b>10 V</b>
<b>11 D</b>	<b>12</b>	<b>GIOVEDI</b> s. Costantino	<b>28</b>	<b>SABATO</b> s. Tommaso d'Aquino	<b>11 S</b>
<b>12 L</b>	<b>13</b>	<b>VENERDI</b> s. Rocco	<b>29</b>	<b>DOMENICA</b> s. Costantino	<b>12 D</b>
<b>13 M</b>	<b>14</b>	<b>SABATO</b> s. Felice	<b>30</b>	<b>LUNEDI</b> s. Martina 7 <sup>a</sup> fest.	<b>13 L</b>
<b>14 M</b>	<b>15</b>	<b>DOMENICA</b> s. Michele	<b>31</b>	<b>MARTEDI</b> s. Giovanni Battista	<b>14 M</b>
<b>15 G</b>	<b>16</b>	<b>LUNEDI</b> s. Sebastiano 7 <sup>a</sup> fest.			<b>15 M</b>
<b>16 V</b>					<b>16 G</b>
<b>17 S</b>					<b>17 V</b>
<b>18 D</b>					<b>18 S</b>
<b>19 L</b>					<b>19 D</b>
<b>20 M</b>					<b>20 L</b>
<b>21 M</b>					<b>21 M</b>
<b>22 G</b>					<b>22 M</b>
<b>23 V</b>					<b>23 G</b>
<b>24 S</b>					<b>24 V</b>
<b>25 D</b>					<b>25 S</b>
<b>26 L</b>					<b>26 D</b>
<b>27 M</b>					<b>27 L</b>
<b>28 M</b>					<b>28 M</b>
<b>29 G</b>					
<b>30 V</b>					
<b>31 S</b>					

RO



		<b>GENNAIO 2023</b>			
	<b>1</b>	<b>DOMENICA</b> Maria Madre di Dio - Capodimonte 12 <sup>a</sup> fest.	<b>17</b>	<b>MARTEDI</b> s. Antonio abate	
<b>1 G</b>	<b>2</b>	<b>LUNEDI</b> ss. Basilio e Gregorio 7 <sup>a</sup> fest.	<b>18</b>	<b>MERCOLEDI</b> s. Liberata	<b>1 M</b>
<b>2 V</b>	<b>3</b>	<b>MARTEDI</b> s. Genesio	<b>19</b>	<b>GIOVEDI</b> s. Maria	<b>2 G</b>
<b>3 S</b>	<b>4</b>	<b>MERCOLEDI</b> ss. Emidio e Cato	<b>20</b>	<b>VENERDI</b> ss. Sebastiano e Paterno	<b>3 V</b>
<b>4 D</b>	<b>5</b>	<b>GIOVEDI</b> s. Anania	<b>21</b>	<b>SABATO</b> s. Agnese	<b>4 S</b>
<b>5 L</b>	<b>6</b>	<b>VENERDI</b> Santina e P.S.	<b>22</b>	<b>DOMENICA</b> s. Innocenzo	<b>5 D</b>
<b>6 M</b>	<b>7</b>	<b>SABATO</b> s. Raimondo di Peñafort	<b>23</b>	<b>LUNEDI</b> s. Eusebio	<b>6 L</b>
<b>7 M</b>	<b>8</b>	<b>DOMENICA</b> Santissimo di Gesù	<b>24</b>	<b>MARTEDI</b> s. Francesco di Sales	<b>7 M</b>
<b>8 M</b>	<b>9</b>	<b>LUNEDI</b> s. Giuliano 7 <sup>a</sup> fest.	<b>25</b>	<b>MERCOLEDI</b> Comeri di s. Paolo	<b>8 M</b>
<b>9 G</b>	<b>10</b>	<b>MARTEDI</b> s. Adalberto	<b>26</b>	<b>GIOVEDI</b> ss. Tito e Simeone	<b>9 G</b>
<b>10 V</b>	<b>11</b>	<b>MERCOLEDI</b> s. Igino	<b>27</b>	<b>VENERDI</b> s. Angela Merici	<b>10 V</b>
<b>11 S</b>	<b>12</b>	<b>GIOVEDI</b> s. Costantino	<b>28</b>	<b>SABATO</b> s. Tommaso d'Aquino	<b>11 S</b>
<b>12 D</b>	<b>13</b>	<b>VENERDI</b> s. Rocco	<b>29</b>	<b>DOMENICA</b> s. Costantino	<b>12 D</b>
<b>13 L</b>	<b>14</b>	<b>SABATO</b> s. Felice	<b>30</b>	<b>LUNEDI</b> s. Martina 7 <sup>a</sup> fest.	<b>13 L</b>
<b>14 M</b>	<b>15</b>	<b>DOMENICA</b> s. Michele	<b>31</b>	<b>MARTEDI</b> s. Giovanni Battista	<b>14 M</b>
<b>15 M</b>	<b>16</b>	<b>LUNEDI</b> s. Sebastiano 7 <sup>a</sup> fest.			<b>15 M</b>
<b>16 G</b>					<b>16 G</b>
<b>17 V</b>					<b>17 V</b>
<b>18 S</b>					<b>18 S</b>
<b>19 D</b>					<b>19 D</b>
<b>20 L</b>					<b>20 L</b>
<b>21 M</b>					<b>21 M</b>
<b>22 M</b>					<b>22 M</b>
<b>23 G</b>					<b>23 G</b>
<b>24 V</b>					<b>24 V</b>
<b>25 S</b>					<b>25 S</b>
<b>26 D</b>					<b>26 D</b>
<b>27 L</b>					<b>27 L</b>
<b>28 M</b>					<b>28 M</b>
<b>29 G</b>					
<b>30 V</b>					
<b>31 S</b>					

VE

# CALENDARI

## AG 2057 OLANDESE STYLE



Calendario mensile 12 fogli, Carta Patinata, Stampa 4 colori, Planning 2024 sul retro dicembre, Festività Internazionali, Testata Termosaldata.

-  Carta patinata 70 gr
-  Calendario 28,8 x 47 cm  
Testata 28,8 x 9 cm
-  100



## AG 2041 SILHOUETTE STYLE

Calendario mensile 12 fogli, Carta Patinata Stampa 4 colori fronte/retro, Planning 2024 sul retro dicembre, Festività Internazionali, Testata Termosaldata.

-  Carta patinata 70 gr
-  Calendario 14 x 47 cm  
Testata 14 x 9 cm
-  100



**DICEMBRE 2022**

Set	48	49	50	51	52
Lun	5	12	19	26	
Mar	6	13	20	27	
Mer	7	14	21	28	
Gio	8	15	22	29	
Ven	9	16	23	30	
Sab	10	17	24	31	
Dom	11	18	25		

**FEBBRAIO 2023**

Set	05	06	07	08	09
Lun	6	13	20	27	
Mar	7	14	21	28	
Mer	1	8	15	22	
Gio	2	9	16	23	
Ven	3	10	17	24	
Sab	4	11	18	25	
Dom	5	12	19	26	

**Il Sole e la Luna**

☉ Soli: 1. ore 7:20 - ore 14:47  
 ☽ Luna: 10. ore 2:21 - ore 14:28  
 ☽ Luna: 19. ore 7:43 - ore 17:12

☉ L.P. giorno 7. ore 16:07  
 ☽ L.P. giorno 14. ore 16:17  
 ☽ L.P. giorno 21. ore 17:02  
 ☽ L.P. giorno 28. ore 18:16

**ACQUARIO**  
21/01 - 19/02

**DICEMBRE 2022**

Set	48	49	50	51	52
Lun	5	12	19	26	
Mar	6	13	20	27	
Mer	7	14	21	28	
Gio	8	15	22	29	
Ven	9	16	23	30	
Sab	10	17	24	31	
Dom	11	18	25		

**FEBBRAIO 2023**

Set	05	06	07	08	09
Lun	6	13	20	27	
Mar	7	14	21	28	
Mer	1	8	15	22	
Gio	2	9	16	23	
Ven	3	10	17	24	
Sab	4	11	18	25	
Dom	5	12	19	26	

**Il Sole e la Luna**



☉ Soli: 1. ore 7:20 - ore 14:47  
 ☽ Luna: 10. ore 2:21 - ore 14:28  
 ☽ Luna: 19. ore 7:43 - ore 17:12

☉ L.P. giorno 7. ore 16:07  
 ☽ L.P. giorno 14. ore 16:17  
 ☽ L.P. giorno 21. ore 17:02  
 ☽ L.P. giorno 28. ore 18:16



## AG 2055 OLANDESE MEDIO STYLE



Calendario Mensile 12 fogli. Stampa 4 colori, testata termosaldata.

-  Carta patinata 80 gr
-  Calendario 22 x 47,4 cm  
Testata 22 x 9 cm
-  100



## AG 2083 CALENDARIO DA TAVOLO STYLE

Spiralato 12 fogli + copertina carta patinata. Planning 2023 sul retro.



-  Carta patinata 100 gr
-  Calendario 12 x 19,5 cm  
Spazio Stampa 12,5 x 4 cm
-  100















# CALENDARI

## AG 2056 OLANDESE MULTIFLUO

Calendario mensile 12 fogli, Carta Patinata, Stampa 4 colori fluo. Festività Internazionali, Testata Termosaldata.

-  Carta patinata 100 gr
-  Calendario 31 x 49 cm  
Testata 31 x 10 cm
-  100



<b>1</b> D  52ª settimana Memò Maria di Gio - Capotenero 12/20	<b>20</b> V s. Sebastiano e Felice 02/301	 <b>ACQUARIO</b> 21/01 - 19/02																																											
<b>2</b> L 1ª settimana s. Basilio e Gregorio 12/20	<b>21</b> S  02/304																																												
<b>3</b> M s. Genoveffa 12/20	<b>22</b> D s. Vito 02/303																																												
<b>4</b> M s. Emere e Caro 12/20	<b>23</b> L 4ª settimana s. Ciriaciana 02/302																																												
<b>5</b> G s. Ambro 12/20	<b>24</b> M s. Francesco di Sales 02/301																																												
<b>6</b> V  Epifania di N.S. 02/20	<b>25</b> M Conversione di s. Paolo 02/20																																												
<b>7</b> S  12/20 s. Feltrando di Perahat 12/20	<b>26</b> G s. Tito e Timoteo 02/300																																												
<b>8</b> D Battesimo di Gesù 02/20	<b>27</b> V s. Angela Merici 02/300																																												
<b>9</b> L 2ª settimana s. Giuliano 02/20	<b>28</b> S  02/300 s. Tommaso d'Aquino 02/20																																												
<b>10</b> M s. Afro 02/20	<b>29</b> D s. Costanzo 02/20																																												
<b>11</b> M s. Ippolito 11/20	<b>30</b> L 3ª settimana s. Martina 02/20																																												
<b>12</b> G s. Costia 12/20	<b>31</b> M s. Giovanni Battista 02/20																																												
<b>13</b> V  12/20 s. Eusebio 12/20	<b>Il Sole e la Luna</b>  <small>Giorno 1 ore 12 min 14.47</small>  <small>1.1. giorno 1 ore 00 min 12.12</small> <small>Giorno 2 ore 12.22 min 14.38</small>  <small>2.1. giorno 1 ore 08 min 11.12</small> <small>Giorno 3 ore 12.30 min 14.17</small>  <small>3.1. giorno 1 ore 04 min 10.12</small>																																												
<b>14</b> S s. Felice 11/20	<b>Dicembre 2022</b>																																												
<b>15</b> D   12/20 s. Mauro 12/20	<table border="1"> <thead> <tr> <th>Lun</th> <th>Mar</th> <th>Mer</th> <th>Gio</th> <th>Ven</th> <th>Sab</th> <th>Dom</th> </tr> </thead> <tbody> <tr> <td></td> <td></td> <td>1</td> <td>2</td> <td>3</td> <td>4</td> <td>5</td> </tr> <tr> <td>6</td> <td>7</td> <td>8</td> <td>9</td> <td>10</td> <td>11</td> <td>12</td> </tr> <tr> <td>13</td> <td>14</td> <td>15</td> <td>16</td> <td>17</td> <td>18</td> <td>19</td> </tr> <tr> <td>20</td> <td>21</td> <td>22</td> <td>23</td> <td>24</td> <td>25</td> <td>26</td> </tr> <tr> <td>27</td> <td>28</td> <td>29</td> <td>30</td> <td>31</td> <td></td> <td></td> </tr> </tbody> </table>		Lun	Mar	Mer	Gio	Ven	Sab	Dom			1	2	3	4	5	6	7	8	9	10	11	12	13	14	15	16	17	18	19	20	21	22	23	24	25	26	27	28	29	30	31			
Lun	Mar		Mer	Gio	Ven	Sab	Dom																																						
			1	2	3	4	5																																						
6	7		8	9	10	11	12																																						
13	14		15	16	17	18	19																																						
20	21		22	23	24	25	26																																						
27	28		29	30	31																																								
<b>16</b> L 3ª settimana s. Morano 12/20	<b>Febbraio 2023</b>																																												
<b>17</b> M s. Antonio abate 11/20	<table border="1"> <thead> <tr> <th>Lun</th> <th>Mar</th> <th>Mer</th> <th>Gio</th> <th>Ven</th> <th>Sab</th> <th>Dom</th> </tr> </thead> <tbody> <tr> <td></td> <td></td> <td>1</td> <td>2</td> <td>3</td> <td>4</td> <td>5</td> </tr> <tr> <td>6</td> <td>7</td> <td>8</td> <td>9</td> <td>10</td> <td>11</td> <td>12</td> </tr> <tr> <td>13</td> <td>14</td> <td>15</td> <td>16</td> <td>17</td> <td>18</td> <td>19</td> </tr> <tr> <td>20</td> <td>21</td> <td>22</td> <td>23</td> <td>24</td> <td>25</td> <td>26</td> </tr> <tr> <td>27</td> <td>28</td> <td></td> <td></td> <td></td> <td></td> <td></td> </tr> </tbody> </table>		Lun	Mar	Mer	Gio	Ven	Sab	Dom			1	2	3	4	5	6	7	8	9	10	11	12	13	14	15	16	17	18	19	20	21	22	23	24	25	26	27	28						
Lun	Mar		Mer	Gio	Ven	Sab	Dom																																						
			1	2	3	4	5																																						
6	7		8	9	10	11	12																																						
13	14		15	16	17	18	19																																						
20	21		22	23	24	25	26																																						
27	28																																												
<b>18</b> M s. Liberata 12/20	<b>2023</b>																																												
<b>19</b> G s. Mario 12/20																																													



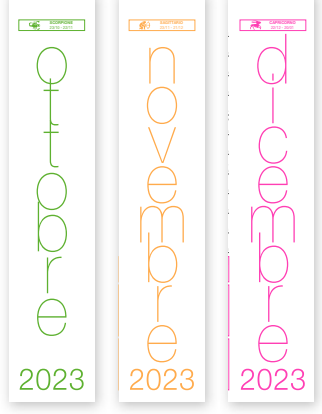
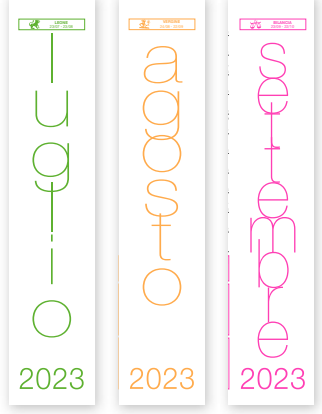

INCHIOSTRI FLUO



## AG 2054 SILHOUETTE MULTIFLUO

Calendario mensile 12 fogli, Carta Patinata Stampa 4 colori fluo. Festività Internazionali, Testata Termosaldata.

-  Carta patinata 100 gr
-  Calendario 14,7 x 49 cm  
Testata 14,7 x 10,2 cm
-  100



**1 D** <sup>52° set.</sup>  
Marta Madre di Dio - Cipociano

**2 L** <sup>1° set.</sup>  
s. Basilio e Gregorio

**3 M**  
s. Genoveffa

**4 M**  
s. Erasmo e Cato

**5 G**  
s. Annulla

**6 V** <sup>1° set.</sup>  
Eduardo di N.S.

**7 S** <sup>2° set.</sup>  
s. Raimondo di Peñafort

**8 D**  
Battesimo di Gesù

**9 L** <sup>2° set.</sup>  
s. Giuliano

**10 M**  
s. Albino

**11 M**  
s. Barno

**12 G**  
s. Costantino

**13 V**  
s. Felice

**14 S**  
s. Felice

**15 D** <sup>1° set.</sup>  
s. Mauro

**16 L** <sup>2° set.</sup>  
s. Maurizio

**17 M**  
s. Antonio abate

**18 M**  
s. Liberto

**19 G**  
s. Mauro

**20 V**  
ss. Sebastiano e Fabiano

**21 S** <sup>3° set.</sup>  
s. Agnese

**22 D** <sup>4° set.</sup>  
s. Vincenzo

**23 L**  
s. Emerenziana

**24 M**  
s. Francesco di Sales

**25 M**  
Conversione di s. Paolo

**26 G**  
ss. Tito e Timoteo

**27 V**  
s. Angiola Merici

**28 S** <sup>5° set.</sup>  
s. Tommaso d'Aquino

**29 D**  
s. Costanzo

**30 L** <sup>6° set.</sup>  
s. Martina

**31 M**  
s. Giovanni Bosco

**DICEMBRE 2022**

Set	48	49	50	51	52
Lun	6	13	20	27	
Mar	7	14	21	28	
Mer	1	8	15	22	29
Gio	2	9	16	23	30
Ven	3	10	17	24	31
Sab	4	11	18	25	
Dom	5	12	19	26	

**FEBBRAIO 2023**

Set	05	06	07	08	09
Lun	6	13	20	27	
Mar	7	14	21	28	
Mer	1	8	15	22	
Gio	2	9	16	23	
Ven	3	10	17	24	
Sab	4	11	18	25	
Dom	5	12	19	26	

**Il Sole e la Luna**

Giorno 1 ore 7:38 ore 16:49  
 Giorno 10 ore 7:37 ore 16:58  
 Giorno 20 ore 7:33 ore 17:10  
 negli 11 giorni del 1° semestre ed 11 giorni del 2° semestre il giorno è più lungo della notte.

☉ L.P. giorno 7 ore 00:09  
 ☽ L.Q. giorno 15 ore 03:13  
 ☊ L.N. giorno 21 ore 21:55  
 ☽ P.Q. giorno 28 ore 18:30





INCHIOSTRI FLUO

# CALENDARI

## AG 2058 OLANDESE MULTIFLUO BLACK

Calendario mensile 12 fogli, Carta Patinata, Stampa 4 colori fluo. Festività Internazionali, Testata Termosaldata.

-  Carta patinata 100 gr
-  Calendario 31 x 49 cm  
Testata 31 x 10 cm
-  100



**1 D** ☽☽☽☽  
Marta Madre di Dio - Capodanno 1-364

**2 L**  
ss. Basilio e Gregorio 2-363

**3 M**  
s. Genoveffa 3-362

**4 M**  
ss. Ermoleo e Gaio 4-361

**5 G**  
s. Amelia 5-360

**6 V** ☽☽  
Epitania di N.S. 6-359

**7 S** ☽  
s. Raimondo di Peñafort 7-358

**8 D**  
Battesimo di Gesù 8-357

**9 L**  
s. Giuliano 9-356

**10 M**  
s. Aldo 10-355

**11 M**  
s. Igino 11-354

**12 G**  
s. Cesira 12-353

**13 V**  
s. Ilario 13-352

**14 S**  
s. Felice 14-351

**15 D** €  
s. Mauro 15-350

**16 L**  
s. Marcello 16-349

**17 M**  
s. Antonio abate 17-348

**18 M**  
s. Liberata 18-347

**19 G**  
s. Mario 19-346

**20 V**  
ss. Sebastiano e Fabiano 20-345

**21 S** ●  
s. Agnese 21-344

**22 D**  
s. Vincenzo 22-343

**23 L**  
s. Eusebio e Carpocrazia 23-342

**24 M**  
s. Francesco di Sales 24-341

**25 M**  
Conversione di s. Paolo 25-340

**26 G**  
ss. Tito e Timoteo 26-339

**27 V**  
s. Angela Merici 27-338

**28 S** ☽  
s. Tommaso d'Aquino 28-337

**29 D**  
s. Costanzo 29-336

**30 L**  
s. Martina 30-335

**31 M**  
s. Giovanni Bosco 31-334

**AGGIORNAMENTO**  
21/01 - 19/02

**Il Sole e la Luna**

Giorno 1	ora 7:35	ora 14:49	G. L.P.	giorno 7	ora 8:04
Giorno 2	ora 7:37	ora 14:50	G. L.P.	giorno 15	ora 8:10
Giorno 3	ora 7:39	ora 14:51	G. L.P.	giorno 23	ora 8:16
Giorno 4	ora 7:41	ora 14:52	G. L.P.	giorno 31	ora 8:22

Lun	Mar	Mer	Gio	Ven	Sab	Dom
		1	2	3	4	5
6	7	8	9	10	11	12
13	14	15	16	17	18	19
20	21	22	23	24	25	26
27	28	29	30	31		

Lun	Mar	Mer	Gio	Ven	Sab	Dom
		1	2	3	4	5
6	7	8	9	10	11	12
13	14	15	16	17	18	19
20	21	22	23	24	25	26
27	28					



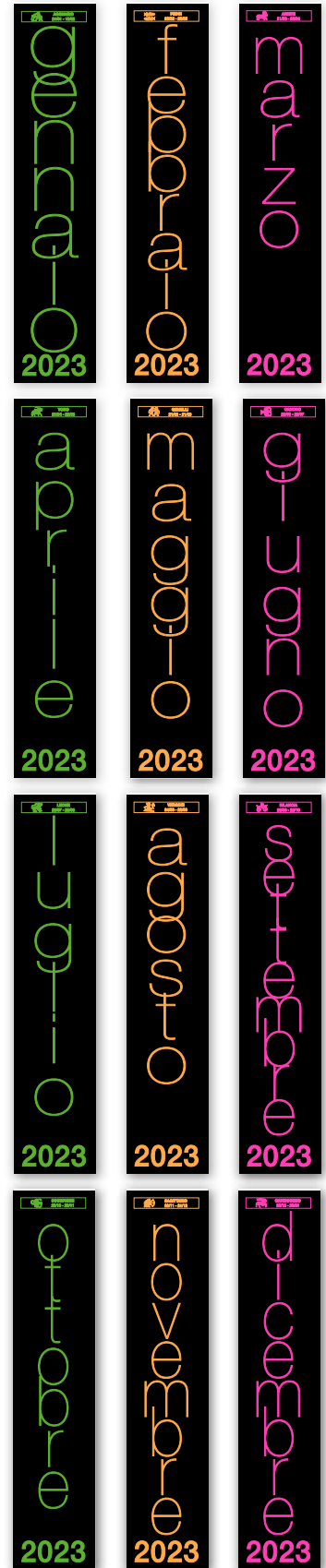

INCHIOSTRI FLUO



**AG 2059**  
**SILHOUETTE**  
**MULTIFLUO BLACK**

Calendario mensile 12 fogli, Carta Patinata Stampa 4 colori fluo. Festività Internazionali, Testata Termosaldata.

-  Carta patinata 100 gr
-  Calendario 14,7 x 49 cm  
Testata 14,7 x 10,2 cm
-  100



**DICEMBRE 2022**

Set	48	49	50	51	52
Lun		6	13	20	27
Mar	7	14	21	28	
Mer	1	8	15	22	29
Gio	2	9	16	23	30
Ven	3	10	17	24	31
Sab	4	11	18	25	
Dom	5	12	19	26	

**FEBBRAIO 2023**

Set	05	06	07	08	09
Lun		6	13	20	27
Mar	7	14	21	28	
Mer	1	8	15	22	
Gio	2	9	16	23	
Ven	3	10	17	24	
Sab	4	11	18	25	
Dom	5	12	19	26	

**Il Sole e la Luna**

Giorno 1 ore 7:38 ore 16:49  
 Giorno 10 ore 7:37 ore 16:55  
 Giorno 20 ore 7:35 ore 17:00  
 Giorno 30 ore 7:33 ore 17:05

☉ L.P. giorno 7 ore 00:09  
 ☽ L.Q. giorno 14 ore 03:13  
 ☽ L.N. giorno 21 ore 21:55  
 ☽ P.Q. giorno 28 ore 16:20



INCHIOSTRI FLUO

# CALENDARI

## AG 2052 OLANDESE MULTIFLUO LUX

Calendario mensile 12 fogli, Carta Patinata, Stampa 4 colori fluo. Festività Internazionali, Testata Termosaldata.

 Carta patinata opaca 100 gr

 Calendario 31 x 49 cm  
Testata 31 x 10 cm

 100



20  
23  
12 mesi per essere felice

g

01.  
gentilezza

Ogni persona che incontri sta combattendo una battaglia di cui non sai nulla. Sii gentile. Sempre (Platone)

gennaio

LUN	2	9	16	23	30
MAR	3	10	17	24	31
MER	4	11	18	25	
GIO	5	12	19	26	
VEN	6	13	20	27	
SAB	7	14	21	28	
DOM	1	8	15	22	29

12 20  
23  
G V S D L M M G V S D L M M G V S D L M M G V S D L M M G V S D L M M G V S  
1 2 3 4 5 6 7 8 9 10 11 12 13 14 15 16 17 18 19 20 21 22 23 24 25 26 27 28 29 30 31

02 20  
23  
M G V S D L M M G V S D L M M G V S D L M M G V S D L M  
1 2 3 4 5 6 7 8 9 10 11 12 13 14 15 16 17 18 19 20 21 22 23 24 25 26 27 28



INCHIOSTRI FLUO

**AG 2016**  
**PORTOGHESE MAXI**  
 Calendario mensile 12 fogli . Carta patinata stampa 2 colori. **Testata rigida rinforzata** in triplo cartoncino.

- Carta patinata 90 gr
- Calendario 31 x 53 cm  
Testata 31 x 10,8 cm
- 100



VE

gennaio

<p><b>1 DOM</b> <sup>52a</sup> Capodanno - Maria Madre di Dio 1-364</p> <p><b>2 LUN</b> <sup>1a</sup> ss. Basilio e Gregorio 2-363</p> <p><b>3 MAR</b> s. Genoveffa 3-362</p> <p><b>4 MER</b> ss. Ermete e Caio 4-361</p> <p><b>5 GIO</b> s. Amelia 5-360</p> <p><b>6 VEN</b> Epifania di N.S. 6-359</p> <p><b>7 SAB</b> s. Raimondo di Penafort 7-358</p> <p><b>8 DOM</b> Battesimo di Gesù 8-357</p> <p><b>9 LUN</b> <sup>2a</sup> s. Giuliano 9-356</p> <p><b>10 MAR</b> s. Aatto 10-355</p> <p><b>11 MER</b> s. Igino 11-354</p> <p><b>12 GIO</b> s. Cesira 12-353</p> <p><b>13 VEN</b> s. Ilario 13-352</p> <p><b>14 SAB</b> s. Felice 14-351</p> <p><b>15 DOM</b> s. Mauro 15-350</p> <p><b>16 LUN</b> <sup>3a</sup> s. Marcello 16-349</p>	<p><b>17 MAR</b> s. Antonio abate 17-348</p> <p><b>18 MER</b> s. Liberata 18-347</p> <p><b>19 GIO</b> s. Mario 19-346</p> <p><b>20 VEN</b> ss. Sebastiano e Fabiano 20-345</p> <p><b>21 SAB</b> s. Agnese 21-344</p> <p><b>22 DOM</b></p> <p><b>23 LUN</b> <sup>4a</sup> s. Emerenziana 23-342</p> <p><b>24 MAR</b></p> <p><b>25 MER</b> Conversi, di s. Paolo 25-340</p> <p><b>26 GIO</b> ss. Tito e Timoteo 26-339</p> <p><b>27 VEN</b> s. Angela Merici 27-338</p> <p><b>28 SAB</b> s. Tommaso d'Aquino 28-337</p> <p><b>29 DOM</b> s. Costanzo 29-336</p> <p><b>30 LUN</b> <sup>5a</sup> s. Martina 30-335</p> <p><b>31 MAR</b> s. Giovanni Bosco 31-334</p>
---	--

dicembre 2022

Lun	Mar	Mer	Gio	Ven	Sab	Dom
5	6	7	8	9	10	11
12	13	14	15	16	17	18
19	20	21	22	23	24	25
26	27	28	29	30	31	

20  
23

febbraio 2023

Lun	Mar	Mer	Gio	Ven	Sab	Dom
6	7	8	9	10	11	12
13	14	15	16	17	18	19
20	21	22	23	24	25	26
27	28					

**L. SOLE**    **Sorge**    **Tramonta**

Giorno 1    ore 07.38    ore 16.49

Giorno 10    ore 07.37    ore 16.58

Giorno 20    ore 07.33    ore 17.10

La festa di 8 settembre del sole ripete il suo corso nel solstizio d'inverno.

RO

gennaio

<p><b>1 DOM</b> <sup>52a</sup> Capodanno - Maria Madre di Dio 1-364</p> <p><b>2 LUN</b> <sup>1a</sup> ss. Basilio e Gregorio 2-363</p> <p><b>3 MAR</b> s. Genoveffa 3-362</p> <p><b>4 MER</b> ss. Ermete e Caio 4-361</p> <p><b>5 GIO</b> s. Amelia 5-360</p> <p><b>6 VEN</b> Epifania di N.S. 6-359</p> <p><b>7 SAB</b> s. Raimondo di Penafort 7-358</p> <p><b>8 DOM</b> Battesimo di Gesù 8-357</p> <p><b>9 LUN</b> <sup>2a</sup> s. Giuliano 9-356</p> <p><b>10 MAR</b> s. Aatto 10-355</p> <p><b>11 MER</b> s. Igino 11-354</p> <p><b>12 GIO</b> s. Cesira 12-353</p> <p><b>13 VEN</b> s. Ilario 13-352</p> <p><b>14 SAB</b> s. Felice 14-351</p> <p><b>15 DOM</b> s. Mauro 15-350</p> <p><b>16 LUN</b> <sup>3a</sup> s. Marcello 16-349</p>	<p><b>17 MAR</b> s. Antonio abate 17-348</p> <p><b>18 MER</b> s. Liberata 18-347</p> <p><b>19 GIO</b> s. Mario 19-346</p> <p><b>20 VEN</b> ss. Sebastiano e Fabiano 20-345</p> <p><b>21 SAB</b> s. Agnese 21-344</p> <p><b>22 DOM</b></p> <p><b>23 LUN</b> <sup>4a</sup> s. Emerenziana 23-342</p> <p><b>24 MAR</b></p> <p><b>25 MER</b> Conversi, di s. Paolo 25-340</p> <p><b>26 GIO</b> ss. Tito e Timoteo 26-339</p> <p><b>27 VEN</b> s. Angela Merici 27-338</p> <p><b>28 SAB</b> s. Tommaso d'Aquino 28-337</p> <p><b>29 DOM</b> s. Costanzo 29-336</p> <p><b>30 LUN</b> <sup>5a</sup> s. Martina 30-335</p> <p><b>31 MAR</b> s. Giovanni Bosco 31-334</p>
---	--

dicembre 2022

Lun	Mar	Mer	Gio	Ven	Sab	Dom
5	6	7	8	9	10	11
12	13	14	15	16	17	18
19	20	21	22	23	24	25
26	27	28	29	30	31	

20  
23

febbraio 2023

Lun	Mar	Mer	Gio	Ven	Sab	Dom
6	7	8	9	10	11	12
13	14	15	16	17	18	19
20	21	22	23	24	25	26
27	28					

**L. SOLE**    **Sorge**    **Tramonta**

Giorno 1    ore 07.38    ore 16.49

Giorno 10    ore 07.37    ore 16.58

Giorno 20    ore 07.33    ore 17.10

La festa di 8 settembre del sole ripete il suo corso nel solstizio d'inverno.

BL

gennaio

<p><b>1 DOM</b> <sup>52a</sup> Capodanno - Maria Madre di Dio 1-364</p> <p><b>2 LUN</b> <sup>1a</sup> ss. Basilio e Gregorio 2-363</p> <p><b>3 MAR</b> s. Genoveffa 3-362</p> <p><b>4 MER</b> ss. Ermete e Caio 4-361</p> <p><b>5 GIO</b> s. Amelia 5-360</p> <p><b>6 VEN</b> Epifania di N.S. 6-359</p> <p><b>7 SAB</b> s. Raimondo di Penafort 7-358</p> <p><b>8 DOM</b> Battesimo di Gesù 8-357</p> <p><b>9 LUN</b> <sup>2a</sup> s. Giuliano 9-356</p> <p><b>10 MAR</b> s. Aatto 10-355</p> <p><b>11 MER</b> s. Igino 11-354</p> <p><b>12 GIO</b> s. Cesira 12-353</p> <p><b>13 VEN</b> s. Ilario 13-352</p> <p><b>14 SAB</b> s. Felice 14-351</p> <p><b>15 DOM</b> s. Mauro 15-350</p> <p><b>16 LUN</b> <sup>3a</sup> s. Marcello 16-349</p>	<p><b>17 MAR</b> s. Antonio abate 17-348</p> <p><b>18 MER</b> s. Liberata 18-347</p> <p><b>19 GIO</b> s. Mario 19-346</p> <p><b>20 VEN</b> ss. Sebastiano e Fabiano 20-345</p> <p><b>21 SAB</b> s. Agnese 21-344</p> <p><b>22 DOM</b></p> <p><b>23 LUN</b> <sup>4a</sup> s. Emerenziana 23-342</p> <p><b>24 MAR</b></p> <p><b>25 MER</b> Conversi, di s. Paolo 25-340</p> <p><b>26 GIO</b> ss. Tito e Timoteo 26-339</p> <p><b>27 VEN</b> s. Angela Merici 27-338</p> <p><b>28 SAB</b> s. Tommaso d'Aquino 28-337</p> <p><b>29 DOM</b> s. Costanzo 29-336</p> <p><b>30 LUN</b> <sup>5a</sup> s. Martina 30-335</p> <p><b>31 MAR</b> s. Giovanni Bosco 31-334</p>
---	--

dicembre 2022

Lun	Mar	Mer	Gio	Ven	Sab	Dom
5	6	7	8	9	10	11
12	13	14	15	16	17	18
19	20	21	22	23	24	25
26	27	28	29	30	31	

20  
23

febbraio 2023

Lun	Mar	Mer	Gio	Ven	Sab	Dom
6	7	8	9	10	11	12
13	14	15	16	17	18	19
20	21	22	23	24	25	26
27	28					

**L. SOLE**    **Sorge**    **Tramonta**

Giorno 1    ore 07.38    ore 16.49

Giorno 10    ore 07.37    ore 16.58

Giorno 20    ore 07.33    ore 17.10

La festa di 8 settembre del sole ripete il suo corso nel solstizio d'inverno.

AR

gennaio

<p><b>1 DOM</b> <sup>52a</sup> Capodanno - Maria Madre di Dio 1-364</p> <p><b>2 LUN</b> <sup>1a</sup> ss. Basilio e Gregorio 2-363</p> <p><b>3 MAR</b> s. Genoveffa 3-362</p> <p><b>4 MER</b> ss. Ermete e Caio 4-361</p> <p><b>5 GIO</b> s. Amelia 5-360</p> <p><b>6 VEN</b> Epifania di N.S. 6-359</p> <p><b>7 SAB</b> s. Raimondo di Penafort 7-358</p> <p><b>8 DOM</b> Battesimo di Gesù 8-357</p> <p><b>9 LUN</b> <sup>2a</sup> s. Giuliano 9-356</p> <p><b>10 MAR</b> s. Aatto 10-355</p> <p><b>11 MER</b> s. Igino 11-354</p> <p><b>12 GIO</b> s. Cesira 12-353</p> <p><b>13 VEN</b> s. Ilario 13-352</p> <p><b>14 SAB</b> s. Felice 14-351</p> <p><b>15 DOM</b> s. Mauro 15-350</p> <p><b>16 LUN</b> <sup>3a</sup> s. Marcello 16-349</p>	<p><b>17 MAR</b> s. Antonio abate 17-348</p> <p><b>18 MER</b> s. Liberata 18-347</p> <p><b>19 GIO</b> s. Mario 19-346</p> <p><b>20 VEN</b> ss. Sebastiano e Fabiano 20-345</p> <p><b>21 SAB</b> s. Agnese 21-344</p> <p><b>22 DOM</b></p> <p><b>23 LUN</b> <sup>4a</sup> s. Emerenziana 23-342</p> <p><b>24 MAR</b></p> <p><b>25 MER</b> Conversi, di s. Paolo 25-340</p> <p><b>26 GIO</b> ss. Tito e Timoteo 26-339</p> <p><b>27 VEN</b> s. Angela Merici 27-338</p> <p><b>28 SAB</b> s. Tommaso d'Aquino 28-337</p> <p><b>29 DOM</b> s. Costanzo 29-336</p> <p><b>30 LUN</b> <sup>5a</sup> s. Martina 30-335</p> <p><b>31 MAR</b> s. Giovanni Bosco 31-334</p>
---	--

dicembre 2022

Lun	Mar	Mer	Gio	Ven	Sab	Dom
5	6	7	8	9	10	11
12	13	14	15	16	17	18
19	20	21	22	23	24	25
26	27	28	29	30	31	

20  
23

febbraio 2023

Lun	Mar	Mer	Gio	Ven	Sab	Dom
6	7	8	9	10	11	12
13	14	15	16	17	18	19
20	21	22	23	24	25	26
27	28					

**L. SOLE**    **Sorge**    **Tramonta**

Giorno 1    ore 07.38    ore 16.49

Giorno 10    ore 07.37    ore 16.58

Giorno 20    ore 07.33    ore 17.10

La festa di 8 settembre del sole ripete il suo corso nel solstizio d'inverno.

495

# CALENDARI

## AG 1990 OLANDESE GIGANTE

Calendario mensile 12 fogli.  
Testata rinforzata.

- Carta naturale 70 gr
- Calendario 31 x 53 cm  
Testata 31 x 10,8 cm
- 100



RO

**GENNAIO 2023**

Dic 2022			Feb 2023
1 Gio	<b>1 DOM</b> Epifania - Festa Madre di Dio	17 MAR s. Antonio abate	1 Mer
2 Ven	<b>2 LUN</b> s. Basilio e Gregorio	18 MER	2 Gio
3 Sab	<b>3 MAR</b> s. Giuseppe	19 GIO	3 Ven
4 Dom	<b>4 MER</b> s. Ermete e Ciri	20 VEN	4 Sab
5 Lun	<b>5 GIO</b> s. Nevio	21 SAB	5 Dom
6 Mar	<b>6 VEN</b> Epifania S.C.	22 DOM	6 Lun
7 Mer	<b>7 SAB</b> s. Pancrazio di Parafati	23 LUN	7 Mar
8 Gio	<b>8 DOM</b> Sottoserra di Gesso	24 MAR	8 Mer
9 Ven	<b>9 LUN</b> s. Giuliano	25 MER	9 Gio
10 Sab	<b>10 MAR</b> s. Ilde	26 GIO	10 Ven
11 Dom	<b>11 MER</b> s. Ignazio	27 VEN	11 Sab
12 Lun	<b>12 GIO</b> s. Clelia	28 SAB	12 Dom
13 Mar	<b>13 VEN</b> s. Felice	29 DOM	13 Lun
14 Mer	<b>14 SAB</b> s. Felice	30 LUN	14 Mar
15 Gio	<b>15 DOM</b> s. Alessio	31 MAR	15 Mer
16 Ven	<b>16 LUN</b> s. Marcello		16 Gio
17 Sab			17 Ven
18 Dom			18 Sab
19 Lun			19 Dom
20 Mar			20 Lun
21 Mer			21 Mar
22 Gio			22 Mer
23 Ven			23 Gio
24 Sab			24 Ven
25 Dom			25 Sab
26 Lun			26 Dom
27 Mar			27 Lun
28 Mer			28 Mar
29 Gio			
30 Ven			
31 Sab			

**A. BOLA** Bergamo **Stampato in Italia**

Giugno 2022 - 100 fogli - 15,00 €  
 Dicembre 2022 - 100 fogli - 15,00 €  
 Gennaio 2023 - 100 fogli - 15,00 €

BL

**GENNAIO 2023**

Dic 2022			Feb 2023
1 Gio	<b>1 DOM</b>	17 MAR	1 Mer
2 Ven	<b>2 LUN</b>	18 MER	2 Gio
3 Sab	<b>3 MAR</b>	19 GIO	3 Ven
4 Dom	<b>4 MER</b>	20 VEN	4 Sab
5 Lun	<b>5 GIO</b>	21 SAB	5 Dom
6 Mar	<b>6 VEN</b>	22 DOM	6 Lun
7 Mer	<b>7 SAB</b>	23 LUN	7 Mar
8 Gio	<b>8 DOM</b>	24 MAR	8 Mer
9 Ven	<b>9 LUN</b>	25 MER	9 Gio
10 Sab	<b>10 MAR</b>	26 GIO	10 Ven
11 Dom	<b>11 MER</b>	27 VEN	11 Sab
12 Lun	<b>12 GIO</b>	28 SAB	12 Dom
13 Mar	<b>13 VEN</b>	29 DOM	13 Lun
14 Mer	<b>14 SAB</b>	30 LUN	14 Mar
15 Gio	<b>15 DOM</b>	31 MAR	15 Mer
16 Ven	<b>16 LUN</b>		16 Gio
17 Sab			17 Ven
18 Dom			18 Sab
19 Lun			19 Dom
20 Mar			20 Lun
21 Mer			21 Mar
22 Gio			22 Mer
23 Ven			23 Gio
24 Sab			24 Ven
25 Dom			25 Sab
26 Lun			26 Dom
27 Mar			27 Lun
28 Mer			28 Mar
29 Gio			
30 Ven			
31 Sab			

VE

**GENNAIO 2023**

Dic 2022			Feb 2023
1 Gio	<b>1 DOM</b>	17 MAR	1 Mer
2 Ven	<b>2 LUN</b>	18 MER	2 Gio
3 Sab	<b>3 MAR</b>	19 GIO	3 Ven
4 Dom	<b>4 MER</b>	20 VEN	4 Sab
5 Lun	<b>5 GIO</b>	21 SAB	5 Dom
6 Mar	<b>6 VEN</b>	22 DOM	6 Lun
7 Mer	<b>7 SAB</b>	23 LUN	7 Mar
8 Gio	<b>8 DOM</b>	24 MAR	8 Mer
9 Ven	<b>9 LUN</b>	25 MER	9 Gio
10 Sab	<b>10 MAR</b>	26 GIO	10 Ven
11 Dom	<b>11 MER</b>	27 VEN	11 Sab
12 Lun	<b>12 GIO</b>	28 SAB	12 Dom
13 Mar	<b>13 VEN</b>	29 DOM	13 Lun
14 Mer	<b>14 SAB</b>	30 LUN	14 Mar
15 Gio	<b>15 DOM</b>	31 MAR	15 Mer
16 Ven	<b>16 LUN</b>		16 Gio
17 Sab			17 Ven
18 Dom			18 Sab
19 Lun			19 Dom
20 Mar			20 Lun
21 Mer			21 Mar
22 Gio			22 Mer
23 Ven			23 Gio
24 Sab			24 Ven
25 Dom			25 Sab
26 Lun			26 Dom
27 Mar			27 Lun
28 Mer			28 Mar
29 Gio			
30 Ven			
31 Sab			



## AG 2084 TRICOLORE DA TAVOLO

Spiralato 13 fogli carta patinata. Planning 2024 sul retro.

- Carta patinata 100 gr
- Calendario 19 x 14 cm  
Spazio Stampa 19 x 4 cm
- 100



## AG 1994 TRICOLORE

Calendario mensile 12 fogli, Carta patinata. Testata rinforzata.

- Carta patinata opaca 70 gr
- Calendario 31 x 53 cm  
Testata 31 x 10,8 cm
- 100



CAPRICORNO 22/12 - 20/1		GENNAIO 2023		Feb 2023	
<b>1</b> DOM	52° sett., Capodanno - Maria Madre di Dio 1-084	<b>17</b> MAR	3° sett., s. Antonio abate 17-548	<b>1</b> Mer	
<b>2</b> LUN	ss. Basilio e Gregorio 2-363	<b>18</b> MER	s. Liberata 18-547	<b>2</b> Gio	
<b>3</b> Sab	1° sett., s. Genoveffa 3-362	<b>19</b> GIO	s. Mario 19-546	<b>3</b> Ven	
<b>4</b> DOM	ss. Ermete e Caio 4-361	<b>20</b> VEN	ss. Sebastiano e Fabiano 20-545	<b>4</b> Sab	
<b>5</b> Lun	s. Amelia 5-360	<b>21</b> SAB	s. Agnese 21-544	<b>5</b> Dom	
<b>6</b> Mar	Epifania di N.S. 6-359	<b>22</b> DOM	s. Vincenzo 22-543	<b>6</b> Lun	
<b>7</b> Mer	s. Raimondo di Peñafort 7-358	<b>23</b> LUN	s. Emerenziana 23-542	<b>7</b> Mar	
<b>8</b> Gio	Battesimo di Gesù 8-357	<b>24</b> MAR	s. Francesco di Sales 24-541	<b>8</b> Mer	
<b>9</b> Ven	s. Giuliano 9-356	<b>25</b> MER	Conversioni di s. Paolo 25-540	<b>9</b> Gio	
<b>10</b> Sab	2° sett., s. Ado 10-355	<b>26</b> GIO	ss. Tito e Timoteo 26-539	<b>10</b> Ven	
<b>11</b> Dom	s. Ippolito 11-354	<b>27</b> VEN	s. Angela Merici 27-538	<b>11</b> Sab	
<b>12</b> Lun	s. Cesira 12-353	<b>28</b> SAB	s. Tommaso d'Aquino 28-537	<b>12</b> Dom	
<b>13</b> Mar	s. Ilario 13-352	<b>29</b> DOM	Feira patronale di Perugia s. Costanzo 29-536	<b>13</b> Lun	
<b>14</b> Mer	s. Felice 14-351	<b>30</b> LUN	s. Martina 30-535	<b>14</b> Mar	
<b>15</b> Gio	s. Mauro 15-350	<b>31</b> MAR	s. Giovanni Bosco 31-534	<b>15</b> Mer	
<b>16</b> Ven	s. Marcellino 16-349			<b>16</b> Gio	
<b>17</b> Sab				<b>17</b> Ven	
<b>18</b> Dom				<b>18</b> Sab	
<b>19</b> Lun				<b>19</b> Dom	
<b>20</b> Mar				<b>20</b> Lun	
<b>21</b> Mer				<b>21</b> Mar	
<b>22</b> Gio				<b>22</b> Mer	
<b>23</b> Ven				<b>23</b> Gio	
<b>24</b> Sab				<b>24</b> Ven	
<b>25</b> Dom				<b>25</b> Sab	
<b>26</b> Lun				<b>26</b> Dom	
<b>27</b> Mar				<b>27</b> Lun	
<b>28</b> Mer				<b>28</b> Mar	
<b>29</b> Gio					
<b>30</b> Ven					
<b>31</b> Sab					

© ART, SYDES      PRODOTTO ITALIA/IND      In vendita al pubblico attraverso una concessione del D.M. 26/10/1975 n. 49

# CALENDARI

## AG 2031 PASSAFOGLI

Mensile 12 fogli, carta uso mano 90 gr.  
stampa 2 colori. Testata doppio strato  
rinforzata.

 Carta uso mano 70 gr

 Calendario 34 x 53,5 cm  
Testata 34 x 9 cm

 100



RO

2023		GENNAIO		CAPRICORNO 2012-2017	
<b>Dic 2022</b>	<b>1 DOM</b> Capodanno - Maria Madre di Dio	17 <b>MAR</b> s. Antonio abate	<b>Feb 2023</b>	1 Mer	
1 Gio	<b>2 LUN</b> s. Basilio e Gregorio	18 <b>MER</b>	2 Gio	2 Ven	
2 Ven	<b>3 MAR</b> s. Genoveffa	19 <b>GIO</b> s. Marco	3 Ven	3 Sab	
3 Sab	<b>4 MER</b> ss. Emale e Calo	20 <b>VEN</b> ss. Sebastiano e Feliciano	4 Sab	<b>5 Dom</b>	
4 Dom	<b>5 GIO</b> s. Arnika	21 <b>SAB</b>	5 Dom	6 Lun	
5 Lun	<b>6 VEN</b> Epifania di N.S.	22 <b>DOM</b> s. Vincenzo	6 Lun	7 Mar	
6 Mar	<b>7 SAB</b> s. Remondo di Perafioti	23 <b>LUN</b> s. Emerenziana	7 Mar	8 Mer	
7 Mer	<b>8 DOM</b> Battesimo di Gesù	24 <b>MAR</b> s. Francesco di Sales	8 Mer	9 Gio	
8 Gio	<b>9 LUN</b> s. Giuliano	25 <b>MER</b> Convers. di s. Paolo	9 Gio	10 Ven	
9 Ven	<b>10 MAR</b> s. Aho	26 <b>GIO</b> ss. Tito e Trifone	10 Ven	11 Sab	
10 Sab	<b>11 MER</b> s. Igino	27 <b>VEN</b> s. Angela Merici	11 Sab	<b>12 Dom</b>	
11 Dom	<b>12 GIO</b> s. Cesia	28 <b>SAB</b> s. Tommaso d'Aquino	12 Dom	13 Lun	
12 Lun	<b>13 VEN</b> s. Ilario	29 <b>DOM</b> s. Costanzo	13 Lun	14 Mar	
13 Mar	<b>14 SAB</b> s. Felice	30 <b>LUN</b> s. Martino	14 Mar	15 Mer	
14 Mer	<b>15 DOM</b> s. Mauro	31 <b>MAR</b> s. Giovanni Battista	15 Mer	16 Gio	
15 Gio	<b>16 LUN</b> s. Marco		16 Gio	17 Ven	
16 Ven			17 Ven	18 Sab	
17 Sab			18 Sab	<b>19 Dom</b>	
18 Dom			19 Dom	20 Lun	
19 Lun			20 Lun	21 Mar	
20 Mar			21 Mar	22 Gio	
21 Mer			22 Gio	23 Ven	
22 Gio			23 Ven	24 Sab	
23 Ven			24 Sab	25 Sab	
24 Sab			25 Sab	26 Dom	
25 Dom			26 Dom	27 Lun	
26 Lun			27 Lun	28 Mar	
27 Mar			28 Mar		
28 Mer					
29 Gio					
30 Ven					
31 Sab					

BL

VE

## AG 2032 PASSAFOGLI

Mensile 12 fogli, carta patinata opaca, stampa 2 colori. Testata doppio strato rinforzata. Allestito con astina in metallo.

 Carta patinata opaca 90 gr

 Calendario 34 x 55 cm  
Testata 34 x 9 cm

 100



RO

GENNAIO 2023		
Dic. 2022	<b>1</b> domenica	<b>17</b> martedì
2	<b>2</b> lunedì	<b>18</b> mercoledì
3	<b>3</b> martedì	<b>19</b> giovedì
4	<b>4</b> mercoledì	<b>20</b> venerdì
5	<b>5</b> giovedì	<b>21</b> sabato
6	<b>6</b> venerdì	<b>22</b> domenica
7	<b>7</b> sabato	<b>23</b> lunedì
8	<b>8</b> domenica	<b>24</b> martedì
9	<b>9</b> lunedì	<b>25</b> mercoledì
10	<b>10</b> martedì	<b>26</b> giovedì
11	<b>11</b> mercoledì	<b>27</b> venerdì
12	<b>12</b> giovedì	<b>28</b> sabato
13	<b>13</b> venerdì	<b>29</b> domenica
14	<b>14</b> sabato	<b>30</b> lunedì
15	<b>15</b> domenica	<b>31</b> martedì
16	<b>16</b> lunedì	

VE

GENNAIO 2023		
1	2	3
4	5	6
7	8	9
10	11	12
13	14	15
16	17	18
19	20	21
22	23	24
25	26	27
28	29	30
31		

BL

GENNAIO 2023		
1	2	3
4	5	6
7	8	9
10	11	12
13	14	15
16	17	18
19	20	21
22	23	24
25	26	27
28	29	30
31		

# CALENDARI

## AG 2065 TRITTICO

Calendario Trimestrale 12 fogli, 3 blocchi spiralati. Carta naturale, testata rinforzata.

 Carta patinata 80 gr

 Calendario 31 x 79,5 cm  
Testata 31 x 20 cm

 100



○

---

### DICEMBRE 2022 DECEMBER

Settimana Week	Lunedì Monday	Martedì Tuesday	Mercoledì Wednesday	Giovedì Thursday	Venerdì Friday	Sabato Saturday	Domenica Sunday
48				1	2	3	4
49	5	6	7	8	9	10	11
50	12	13	14	15	16	17	18
51	19	20	21	22	23	24	25
52	26	27	28	29	30	31	

---

### GENNAIO 2023 JANUARY

Settimana Week	Lunedì Monday	Martedì Tuesday	Mercoledì Wednesday	Giovedì Thursday	Venerdì Friday	Sabato Saturday	Domenica Sunday
52							1
1	2	3	4	5	6	7	8
2	9	10	11	12	13	14	15
3	16	17	18	19	20	21	22
4/5	23/30	24/31	25	26	27	28	29

---

### FEBBRAIO 2023 FEBRUARY

Settimana Week	Lunedì Monday	Martedì Tuesday	Mercoledì Wednesday	Giovedì Thursday	Venerdì Friday	Sabato Saturday	Domenica Sunday
5			1	2	3	4	5
6	6	7	8	9	10	11	12
7	13	14	15	16	17	18	19
8	20	21	22	23	24	25	26
9	27	28					

VE

RO

○

---

### DICEMBRE 2022 DECEMBER

Settimana Week	Lunedì Monday	Martedì Tuesday	Mercoledì Wednesday	Giovedì Thursday	Venerdì Friday	Sabato Saturday	Domenica Sunday
48				1	2	3	4
49	5	6	7	8	9	10	11
50	12	13	14	15	16	17	18
51	19	20	21	22	23	24	25
52	26	27	28	29	30	31	

---

### GENNAIO 2023 JANUARY

Settimana Week	Lunedì Monday	Martedì Tuesday	Mercoledì Wednesday	Giovedì Thursday	Venerdì Friday	Sabato Saturday	Domenica Sunday
52							1
1	2	3	4	5	6	7	8
2	9	10	11	12	13	14	15
3	16	17	18	19	20	21	22
4/5	23/30	24/31	25	26	27	28	29

---

### FEBBRAIO 2023 FEBRUARY

Settimana Week	Lunedì Monday	Martedì Tuesday	Mercoledì Wednesday	Giovedì Thursday	Venerdì Friday	Sabato Saturday	Domenica Sunday
5			1	2	3	4	5
6	6	7	8	9	10	11	12
7	13	14	15	16	17	18	19
8	20	21	22	23	24	25	26
9	27	28					

## AG 2066 TRITTICO MULTICOLOR

Calendario trimestrale 3 blocchi  
spiralati. Testata rinforzata

 Carta patinata opaca 90 gr

 Calendario 31 x 79,5 cm  
Testata 31 x 19,4 cm

 50



### DECEMBRE 2022

SETTIMANA WEEK WOCHE	LUNEDI MONDAY MONTAG	MARTEDI TUESDAY DIENSTAG	MERCOLEDI WEDNESDAY MITTWOCH	GIOVEDI THURSDAY DONNERSTAG	VENERDI FRIDAY FREITAG	SABATO SATURDAY SAMSTAG	DOMENICA SUNDAY SONNTAG
48				1	2	3	4
49	5	6	7	8	9	10	11
50	12	13	14	15	16	17	18
51	19	20	21	22	23	24	25
52	26	27	28	29	30	31	

### JANUARY 2023

SETTIMANA WEEK WOCHE	LUNEDI MONDAY MONTAG	MARTEDI TUESDAY DIENSTAG	MERCOLEDI WEDNESDAY MITTWOCH	GIOVEDI THURSDAY DONNERSTAG	VENERDI FRIDAY FREITAG	SABATO SATURDAY SAMSTAG	DOMENICA SUNDAY SONNTAG
52							1
1	2	3	4	5	6	7	8
2	9	10	11	12	13	14	15
3	16	17	18	19	20	21	22
4/5	23/30	24/31	25	26	27	28	29

### FEBRUARY 2023

SETTIMANA WEEK WOCHE	LUNEDI MONDAY MONTAG	MARTEDI TUESDAY DIENSTAG	MERCOLEDI WEDNESDAY MITTWOCH	GIOVEDI THURSDAY DONNERSTAG	VENERDI FRIDAY FREITAG	SABATO SATURDAY SAMSTAG	DOMENICA SUNDAY SONNTAG
5			1	2	3	4	5
6	6	7	8	9	10	11	12
7	13	14	15	16	17	18	19
8	20	21	22	23	24	25	26
9	27	28					

# CALENDARI

## AG 2072 PORTOGHESE DA TAVOLO

Spiralato 13 fogli carta patinata. Planning 2024 sul retro.



 Carta patinata opaca 100 gr  100

 Calendario 19 x 14,5 cm  
Spazio Stampa 19 x 4 cm



## AG 2085 TRIMESTRALE DA TAVOLO

Spiralato 13 fogli carta patinata. Planning 2024 sul retro.



 Carta patinata 80 gr  100

 Calendario 19 x 14,5 cm  
Spazio Stampa 19 x 4 cm



## AG 2070 MULTICOLOR DA TAVOLO



Calendario mensile spiralato da tavolo 12 fogli + copertina.

-  Carta patinata opaca 100 gr
-  Calendario 19 x 14,5 cm  
Spazio Stampa 19,1 x 4 cm
-  100



## AG 2071 CALENDARIO DA TAVOLO

Calendario mensile spiralato da tavolo 12 fogli + copertina.



-  Carta naturale 80 gr
-  Calendario 25 x 14,5 cm  
Spazio Stampa 25 x 3,5 cm
-  100



# CALENDARI

## AG 2080 CALENDARIO TRIMESTRALE DA TAVOLO



Spiralato 13 fogli carta patinata. Planning 2024 sul retro.

-  Carta patinata 100 gr
-  Calendario 19 x 14,5 cm  
Spazio Stampa 19 x 4 cm
-  100



## AG 2081 CALENDARIO TRIMESTRALE DA TAVOLO

Spiralato 13 fogli carta patinata. Planning 2024 sul retro.



-  Carta patinata 100 gr
-  Calendario 19 x 14 cm  
Spazio Stampa 19 x 4 cm
-  100





## AG 2084 TRICOLORE DA TAVOLO



Spiralato 13 fogli carta patinata.  
Planning 2024 sul retro.

-  Carta patinata 100 gr
-  Calendario 19 x 14,5 cm  
Spazio Stampa 19 x 4 cm
-  100



## AG 2083 CALENDARIO DA TAVOLO STYLE

Spiralato 12 fogli + copertina carta patinata.  
Planning 2023 sul retro.



-  Carta patinata 100 gr
-  Calendario 12 x 19,5 cm  
Spazio Stampa 12,5 x 4 cm
-  100



# CALENDARI

## AG 2075 SAN PIO CALENDARIO DA TAVOLO

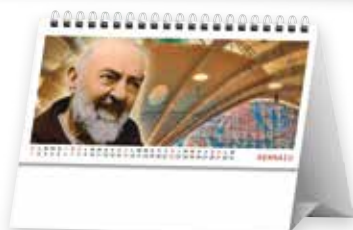
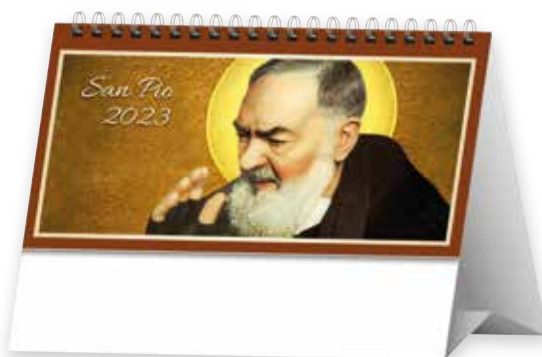

Spiralato 13 fogli carta patinata.  
Planning 2024 sul retro.

-  Carta patinata 100 gr
-  Calendario 19 x 14,5 cm  
Spazio Stampa 19 x 4 cm
-  100



## AG 2079 CITTÀ D'ITALIA CALENDARIO DA TAVOLO

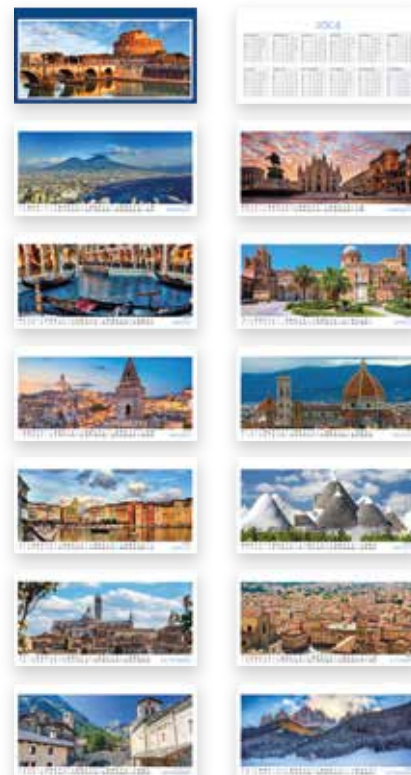
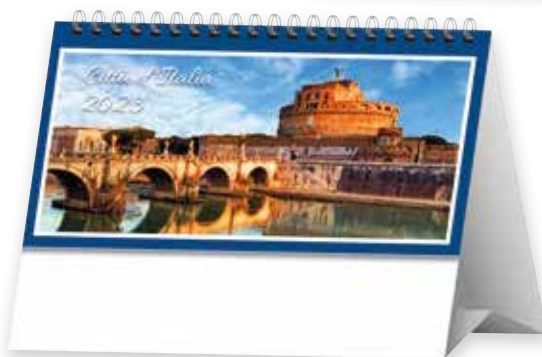

Spiralato 13 fogli carta patinata.  
Planning 2024 sul retro.

-  Carta patinata 100 gr
-  Calendario 19 x 14,5 cm  
Spazio Stampa 19 x 4 cm
-  100



## AG 2073 AUTO SPORTIVE CALENDARIO DA TAVOLO

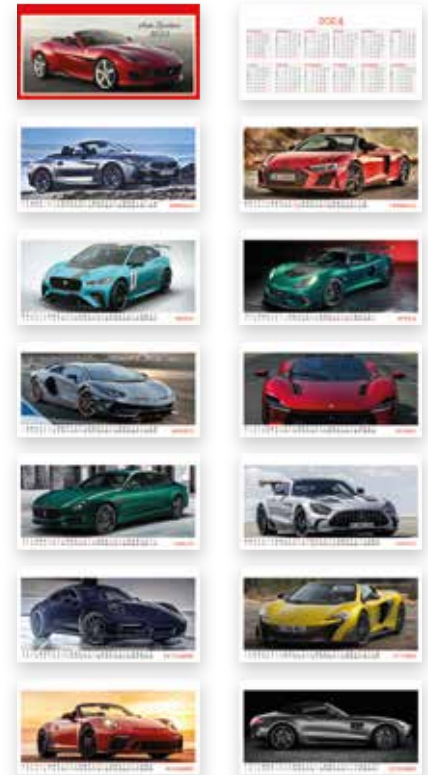

Spiralato 13 fogli carta patinata.  
Planning 2024 sul retro.

-  Carta patinata 100 gr
-  Calendario 19 x 14,5 cm  
Spazio Stampa 19 x 4 cm
-  100



## AG 2078 CANI E GATTI CALENDARIO DA TAVOLO

Spiralato 13 fogli carta patinata.  
Planning 2024 sul retro.

-  Carta patinata 100 gr
-  Calendario 19 x 14,5 cm  
Spazio Stampa 19 x 4 cm
-  100

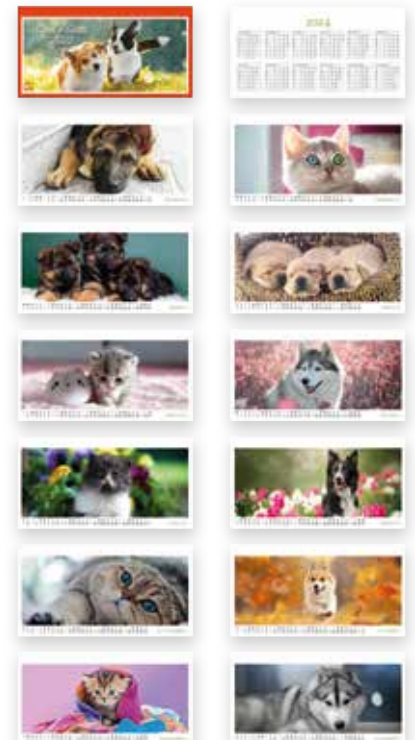



# INDICE

7

## ABBIGLIAMENTO

T-SHIRT  
POLO  
FELPE  
PILE  
GIUBBINI  
GILET  
SPORT WEAR  
WORK  
IGIENE & PROTEZIONE  
CAPPELLI

167

## GRANDI FIRME

THE BRIDGE  
HUGO BOSS  
CERRUTI  
LAVILLE PARIS  
JAGUAR  
CHRISTIAN LACROIX

201

## MEETING&NOTES

ZAINI  
BORSE  
CARTELLE  
PORTABLOCCO  
BUSTE  
BLOCK NOTES  
TACCUINI  
SET MEMO  
CUBO CARTA

225

## PENNE

PENNE MAXEMA  
PENNE PARKER  
PENNE HUGO BOSS  
PENNE LAVILLE  
PENNE STILOLINEA  
MATITE  
STILOFORI  
SET COLORI  
ASTUCCI PORTAPENNE

273

## ACCENDINI

ACCENDINI IN PLASTICA  
ACCENDINI IN METALLO  
ACCENDIGAS  
POSACENERE

279

## PORTACHIAVI

PORTACHIAVI  
LANYARD  
PORTABADGE  
BRACCIALETTI

291

## HI-TECH & OFFICE

CALCOLATRICI  
PORTA PENNE  
POWER BANK  
SPEAKER  
CHIAVETTE USB  
AURICOLARI  
PORTACHIAVI TOUCH  
TAPPETINI MOUSE  
OROLOGI DA PARETE

309

## SHOPPER

SHOPPER IN COTONE  
SHOPPER IN TNT  
SHOPPER IN PPL  
SHOPPER RICHIUDIBILI  
PORTABICCHIERE  
PORTABOTTIGLIE

329

## WINE&HOME

LUNCH BOX  
POSATE  
TAZZE  
BICCHIERI  
BILANCIA  
APRIBOTTIGLIE  
SET VINO  
TAGLIERE  
TAGLIAPIZZA  
GREMBIULI

345

## BEAUTY

SPECCHIETTI  
SET MANICURE  
SPAZZOLE  
PETTINE  
BEAUTY  
POCHETTE  
LIME PER UNGHIE  
VENTAGLIO  
PENNA ROSSETTO

351

## OMBRELLI

OMBRELLI AUTOMATICI  
OMBRELLI MAXI  
OMBRELLI MINI  
OMBRELLI PIEGHEVOLI  
OMBRELLO LAVILLE

359

## TERMOSALDATI

PORTACARD  
PORTALOTTO  
PORTARICETTE  
PORTABIGLIETTO AEREO  
PORTANOME VALIGIE

365

## AUTO&MOTO

PORTA DOCUMENTI  
PORTA ASSICURAZIONI  
PORTA TARGA  
PORTA POLIZZA  
DISCO ORARIO

373

## UTILITY

FLESSOMETRI  
DOPPIO METRO  
MATITA FALEGNAME  
TAGLIERINI  
ARTICOLI  
FARMACEUTICI  
PORTASCARPE  
PORTA ABITI  
CALZASCARPE

379

## ZAINI&SPORTBAG

ZAINI PORTA PC  
ZAINI TEMPO LIBERO  
ZAINI CAMOUFLAGE  
BORSONI SPORT

403

## TEMPO LIBERO

BORRACCE  
TAZZE  
BICCHIERI  
LUNCH BOX  
SET POSATE  
BILANCIA  
BORSA TERMICA  
VENTAGLIO  
OCCHIALI DA SOLE  
PORTA CELLULARE  
BRACCIALETTI

415

## AGENDE

AGENDE IN PELLE  
AGENDE IN SIMILPELLE  
AGENDE BLOCCO FISSO  
AGENDE IN VIVELLA  
AGENDINE TASCABILI  
PLANNING CON SPIRALE

453

## CALENDARI

CALENDARI DA PARETE  
CALENDARI DA TAVOLO  
PLANNING

# INDICE ANALITICO

DESCRIZIONE	PAGINA	DESCRIZIONE	PAGINA
ACCENDINI E ACCENDIGAS	274-278	CHIAVETTE USB	294-295
AGENDE	416-452	CINTURA UOMO	172,175
ALTA VISIBILITÀ	136-141	COLLARINI	290
APRIBOTTIGLIA	334-335	COLORI	270-271
ARTICOLI SPORTIVI	104-108	CONTENITORI CIBO	330-331
ASTUCCI	272	COPERTA IN PILE	412
AURICOLARI	187, 300-301	CUBO CARTA	224
BANDANA	162	CUFFIE DA PISCINA	108
BEAUTY	346-350	CUSTODIA PORTACELLULARE	413
BEAUTY CASE	171,185,191,200,348	CUTTER	375
BERMUDA	135	DIFF. SPRAY DISINFETTANTE	377
BICCHIERE	333	DISCO ORARIO	369
BILANCIA DA CUCINA	331	DISPENSER NASTRO ADESIVO	304
BLOCCO NOTES	216-217,219-220	DOPPIO METRO	375
BORRACCIA	186,404-407	FASCIA SCALDACOLLO	163
BORSA DONNA	177-183	FELPE	48-65,125
BORSA DA SHOPPING	310-327	FLESSOMETRI	374
BORSA DA VIAGGIO	170,196-197,200	FOULARD	162
BORSA PORTABOTTIGLIA	328	GEL DISINFETTANTE	150
BORSA PORTACOMPUTER	168-169,179,209	GIACCA IMPERMEABILE	88,105
BORSA PORTADOCUMENTI	168-169,174,179,209	GILET	72,91-102
BORSA PORTASCARPE	378	GIUBBINI	74-88
BORSA TERMICA	412	GREMBIULE	112-117,338-344
BORSONE SPORTIVO	107, 398-402	GUANTI MONOUSO	151
BRACCIALETTI	302,413	KIT PRONTO SOCCORSO	152
BUSTA PORTADOCUMENTI	215	LANYARD	290
CALCOLATRICE	292,303	LEVA FUSTELLE	377
CALENDARI ILLUSTRATI	454-479	LIME PER UNGHIE	350
CALENDARI SILHOUETTE	478-481,488,491,493	MAGLIA TERMICA	119-120,122-123
CALENDARI OLANDESI	481-490,492,496	MASCHERINE	150
CALENDARI FLUO	490-494	MATITE	268-269
CALENDARI TRITTICI	500-501	MATITA FALEGGNAME	375
CALENDARI DA TAVOLO	502-507	MEMO	221-223
CALZARI MONOUSO	151	MOUSE PAD	173
CALZASCARPE	378	NECESSAIRE	181
CAMICIA	124	OCCHIALI DA SOLE	414
CAMICE DA LAVORO	110-111	OCCHIALINI DA PISCINA	108
CAMICE DI PROTEZIONE	151	OMBRELLI	352-358
CANNUCCE	330	OROLOGIO DA PARETE	306-308
CANOTTE	22	OROLOGIO DA SCRIVANIA	292
CAPPELLI	154-161	PALLINA DI NATALE	194
CARICABATTERIE AUTO	297	PALLONE DA CALCIO	107
CARICABATTERIE USB	296-298	PANTALONI	126-134
CARICATORE WIRELESS	188,293,296	PANTALONI FELPATI	66
CARTELLA	210,213	PANTALONI TERMICI	121
CARTELLA PORTADOCUMENTI	173,'190,209-211	PASSAFOGLI	498-499
CASSE SPEAKER	299	PENNA ANTIBATTERICA	253
CAVATAPPI	334	PENNE HUGO BOSS	232-233
CAVO DI RICARICA USB	296-297	PENNE IN ALLUMINIO	235-240

DESCRIZIONE	PAGINA	DESCRIZIONE	PAGINA
PENNE IN BAMBOO	248	SHOPPER IN COTONE	310-315
PENNE IN CARTONCINO	249	SHOPPER IN TNT	316-325
PENNE IN METALLO	227-229,234,237-238, 241,245,250-252,254-256	SHOPPER IN PPL	326-327
PENNE IN PLASTICA	244,250-267	SOFT-SHELL	82-87
PENNE IN PLASTICA RICICLATA	243,247	SPAZZOLA	347
PENNE LAVILLE	234	SPAZZOLINO DA VIAGGIO	377
PENNE MADE IN ITALY	227,243-247	SPEAKER BLUETOOTH	187-188,293,299
PENNE MAXEMA	227,243-244	SPECCHIETTO BORSA	346-348
PENNE PARKER	229-230	STAZIONE METEREologica	292
PENNE ROSSETTO	350	STILOFORO CON SPIRALE	266
PENNE SIRINGA	267	SUPPORTO PER SMARTPHONE	293,297,302
PENNE TOUCH	238-241, 250-251, 256,267	TACCUINO	218
PETTINE	347	TAGLIA PIZZA	334
PILE	68-72	TAGLIERE DA CUCINA	336
PLANNING	443,508	TAGLIERINO	375
POCHETTE	349	TAPPETINO MOUSE	303
POLO	24-46	TAZZE	332-333
PORTA ABITI	378	TEMPERAMATITE	272
PORTA BICCHIERE	328	TRACOLLE	174,177,178,182,191
PORTA BADGE	290	TROLLEY	170,189,193,198-199
PORTA BIGLIETTI	364	T-SHIRT	9-21
PORTABLOCCO	209-214	TUTA DI PROTEZIONE	151
PORTA CARDS	190,195, 360-363	TUTA SPORTIVA	104
PORTA CELLULARE	297,413	USB	294-295
PORTACHIAVI	267,280-289	VALIGETTA PRONTO SOCCORSO	152
PORTACHIAVI FIRMATI	174,195	VASSOIO DA SCRIVANIA	303
PORTA DOCUMENTI AUTO	366-369	VENTAGLIO	414
PORTAFOGLI	172,175-177,181,191	ZAINI	380-397
PORTA NOME BAGAGLIO	364	ZAINI FIRMATI	168-169,178,180,184,192,200
PORTA MASCHERINA	362	ZAINO PORTA COMPUTER	380-386
PORTA LOTTO	364	ZAINO TROLLEY	198
PORTA RICETTE	364	ZUCCOTTI	164
PORTA PENNE	292,305		
PORTA PILLOLE	376		
PORTA TARGA AUTO	370-372		
PORTA TARGA MOTO	372		
POSACENERE	278		
POSATE	330-331		
POWER BANK	296-298		
PROFUMATORE AMBIENTE	194		
QUADERNO MINI	221		
ROTELLA METRICA	374		
RIGHELLI	304		
SCALDACOLLO	163		
SCARPE DA LAVORO	143-148		
SCIARPA	195		
SET DA VIAGGIO	196-197		
SET MANICURE	346		
SET VINO	336		